



DENTAL EL ALETLERİ

DENTAL INSTRUMENTS



ŞİRKET

Firmamız 1998 yılında kurulmuştur.

Onur Diş Deposu sürekli gelişen bünyesi ve sektöründeki dinamikleri ile ürün yelpazesini genişletmeye devam etmektedir.

Firmamız; ürün tercihlerinde kalite, dayanıklılık ve maliyet faktörlerini ön planda tutarak sektörün önde gelen markalarını diş hekimlerine, diş hastanelerine ve polikliniklerine sunmaktadır.

Ülke çapındaki bayi ağımla her bölgenin ihtiyaçlarına cevap vermekteyiz.

Misyonumuz, dental sektöründeki tüm yenilik ve gelişmeleri yakından izleyerek geçmiş başarılarımızdan aldığımız güçle geleceğe ışık tutmaktır.

Bu anlamda sürekli yenilenen ve genişleyen ürün yelpazemiz teknolojik ve ekonomik gelişmeler sayesinde şekillenmektedir.

Hedefimiz müşterilerimizin isteklerini ve seçimlerini ön planda tutarak dürüst, güvenilir, şeffaf ve yenilikçi yaklaşımlarımızla siz hekimlerimizin mutluluğunu ve uzun vadeli kazancını her şeyden önde tutarak hizmet vermektir.

Our company established in 1998.

Onur Dental continues to expand its product range with its constantly developing structure and its dynamics at the dental field.

Our company is keeping the quality, durability and cost factors in the foreground in the product preferences to present the leading brands of the sector to dentists, dental hospitals and polyclinics.

With our nationwide dealer network we meet the needs of every region.

Our mission is to shed light on the future by following all innovations and developments in the dental sector closely with the power we received from our past achievements. In this sense, our constantly renewed and expanding product range is shaped by technological and economic developments.

Our goal is to serve our customers by keeping their happiness and long-term benefits ahead of all with honest, reliable, transparent and innovative approaches by prioritizing our customers' requests and choices.





ONUR DİŞ DEPOSU

Tıbbi Gereçler San. ve Tic. Ltd. Şti

MERKEZ / Head Office

Millet Caddesi Lütfüpaşa
Sk. No:50/134093 FATİH
İSTANBUL/TÜRKİYE

Tel : +09 212 635 78 84
Tel : +09 212 635 78 85
Tel : +09 212 635 78 86
Fax : +09 212 635 78 90
E-mail : info@onurdental.com
Web : www.onurdental.com

ÜRETİM / Manufacture

İlkadım Sanayi Bölgesi
İstiklal Mahallesi 53. Sk No:39
Tekkeköy- Samsun/TÜRKİYE

Tel : +09 362 231 34 34
Fax : +09 362 231 34 33
E-mail : info@onurdental.com
Web : www.onurdental.com

ŞUBE / Branch Office

Varlık Mahallesi 100.Yıl
Bulvarı Gazi Apt. No:99A
Muratpaşa-Antalya/TÜRKİYE

Tel : +09 242 244 10 30
Fax : +09 242 244 10 40
E-mail : info@onurdental.com
Web : www.onurdental.com



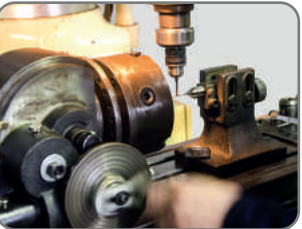
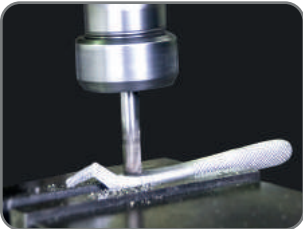


**DENTAL
INSTRUMENTS**

**SURGICAL
INSTRUMENTS**

**DENTAL
EQUIPMENT**

**CONTAINER
SYSTEMS**





ÜRÜN İÇERİKLERİ

INSTRUMENTS CONTENTS



DAVYELER / EXTRACTING FORCEPS

8 / 19



ELEVATÖRLER / ELEVATORS

22 / 36



MAKASLAR / SCISSORS

38 / 48



PORTEGÜLER / NEEDLE HOLDERS

50 / 56



KLEMPLER / FORCEPS

58 / 64



PENSETLER / TWEEZERS

66 / 74



EKARTÖRLER / RETRACTORS

76 / 88



KEMİK PENSLERİ / BONE RONGEURS

92



KEMİK KÜRETLERİ / BONE CURETTES

93 / 95



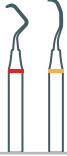
KEMİK EĞELERİ / BONE FILES

96



PERİODONTAL KÜRETLER / *PERIODONTAL CURETTES*

98 / 99



GRACEY KÜRETLER / *GRACEY CURETTES*

100 / 102



TİTANYUM İMPLANT SCALERS / *TITANIUM IMPLANT SCALERS*

103



PERİODONTAL BIÇAKLAR / *PERIODONTAL KNIVES*

99



PERİODONTAL SONDLAR / *PERIODONTAL PROBES*

104



PERİODONTAL ÇİZELLER / *PERIODONTAL CHISELS*

105



KRETUARLAR / *CURETTES*

106 / 107



KOMPOZİT ALETLER / *COMPOSITE INSTRUMENTS*

10 / 116



SİMAN SİPATÜLLER / *CEMENT SPATULAS*

117



RUBBER DAM / *RUBBER DAM*

118

| | | |
|---|--------------------------|------------|
|  | AYNALAR / MIRRORS | 119 |
|---|--------------------------|------------|

| | | |
|--|-------------------------|------------|
|  | SONDLAR / PROBES | 120 |
|--|-------------------------|------------|

| | | |
|--|--|------------------|
|  | AMALGAM TABANCASI / AMALGAM GUN | 121 / 122 |
|--|--|------------------|

| | | |
|--|---|------------------|
|  | MATRİKS TUTUCULAR / MATRIX HOLDERS | 123 / 124 |
|--|---|------------------|

| | | |
|--|---------------------------|------------------|
|  | CERRAHİ / SURGICAL | 126 / 147 |
|--|---------------------------|------------------|

| | | |
|--|--------------------------------|------------|
|  | ENJEKTÖRLER / INJECTORS | 147 |
|--|--------------------------------|------------|

| | | |
|--|---|------------------|
|  | ÇENE CERRAHİSİ / MAXILLOFACIAL SURGERY | 150 / 190 |
|--|---|------------------|

| | | |
|--|---------------------------------|------------------|
|  | ORTODONTİ / ORTHODONTICS | 192 / 202 |
|--|---------------------------------|------------------|

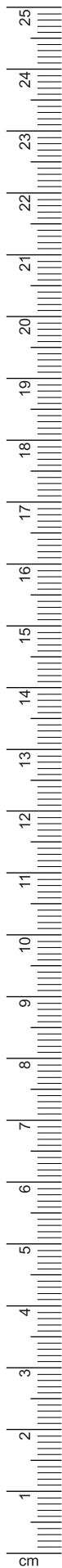
| | | |
|--|---|------------------|
|  | KONTEYNER SİSTEMLERİ / CONTAINER SYSTEMS | 204 / 221 |
|--|---|------------------|

| | | |
|--|-----------------------|------------------|
|  | İNDEKS / INDEX | 224 / 241 |
|--|-----------------------|------------------|



DAVYELER
EXTRACTING FORCEPS

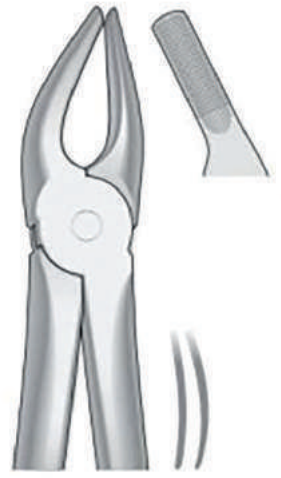




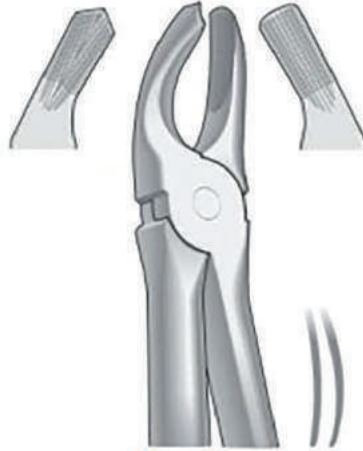
1
FC001
Üst Kesici
Upper Incisors



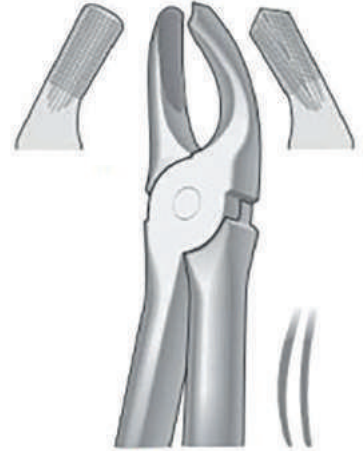
2
FC002
Üst Kesici
Upper Incisors



7
FC007
Üst Küçük Azı
Upper Premolar



17
FC017
Üst Büyük Azı Sağ
Upper Molars Right



18
FC018
Üst Büyük Azı Sol
Upper Molars Left



13
FC013
Alt Küçük Azı
Lower Premolar



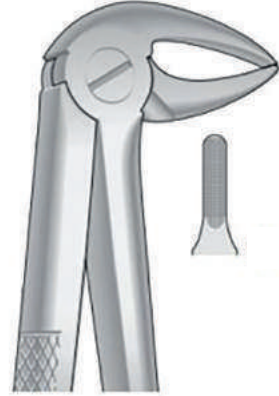
22
FC022
Alt Büyük Azı
Lower Molar



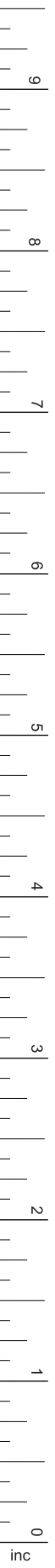
33
FC033
Alt Kesici ve Kök
Lower Incisors and Roots

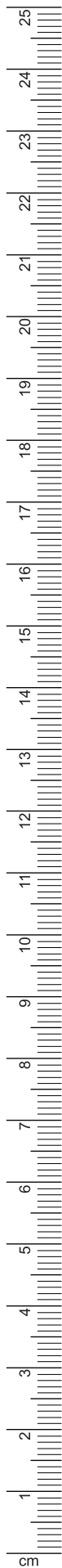


73
FC073
Alt Büyük Azı
Lower Molars



33A
FC33A
Alt Kök
Lower Roots





4
FC004
Alt Kesici ve Kanin
Lower Incisors and Canines



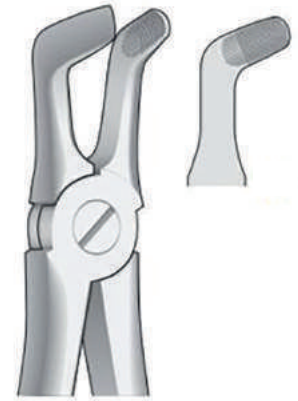
8
FC008
Alt Küçük Azı
Lower Premolar



21
FC021
Alt Büyük Azı
Lower Molar



79
FC079
Alt Üçüncü Azı
Lower Third Molar



79A
FC79A
Alt Üçüncü Azı
Lower Third Molar



51
FC051
Üst Kök
Upper Roots



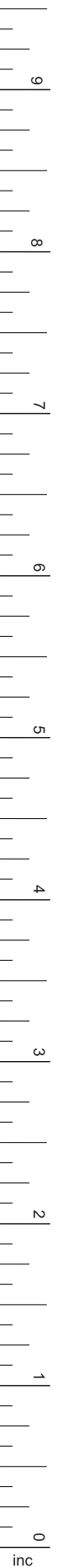
51A
FC51A
Üst Kök
Upper Roots

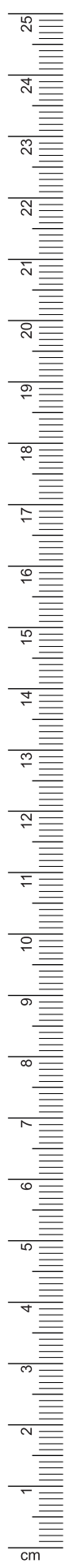


51L
FC51L
Üst Kök
Upper Roots



67
FC067
Üst Üçüncü Azı
Upper Third Molars

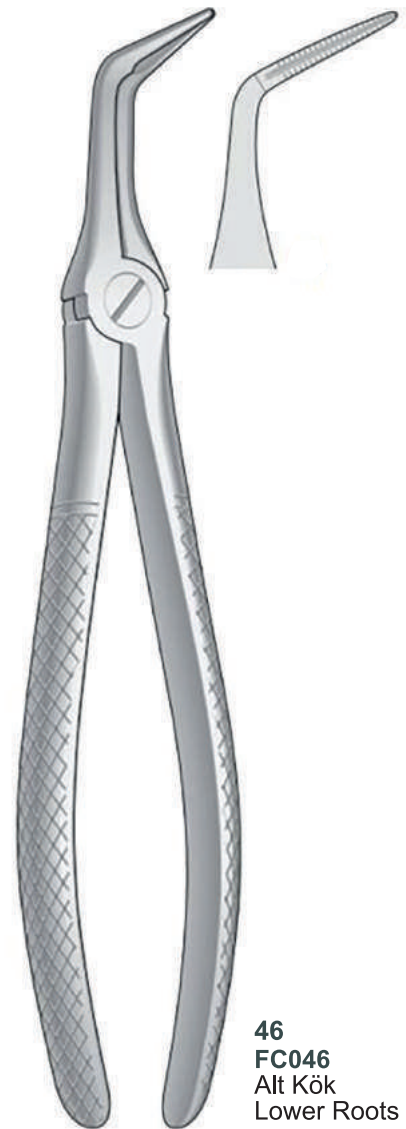




49
FC049
Üst Kök
Upper Roots



48
FC048
Üst Kök
Upper Roots



46
FC046
Alt Kök
Lower Roots



74N
FC74N
Alt Kök ve Kesiciler
Lower Roots and Incisors



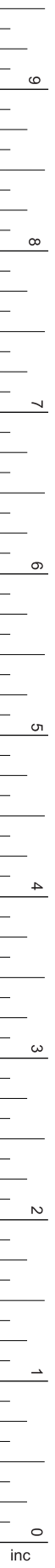
74
FC074
Alt Kök ve Kesiciler
Lower Roots and Incisors



75
FC075
Alt Kesiciler
Lower Incisors

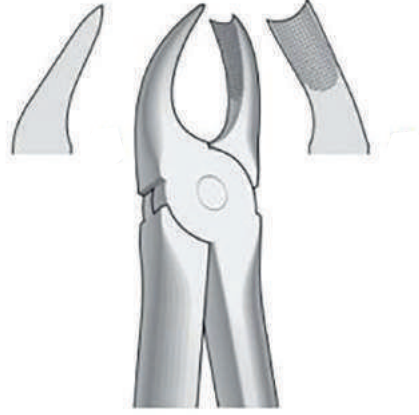


86A
FC86A
Alt Azı Çürük
Lower Molar Decayed





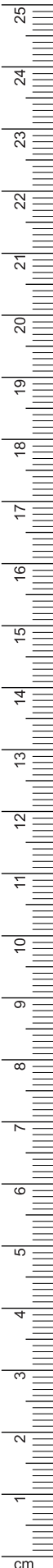
87
FC087
Alt Büyük Azı, Çürümüş veya
Parçalanmış Dişler
Lower Molar Decayed
or Broken Down Crowns



89
FC089
Üst Büyük Azı Sağ
Upper Molars, Right



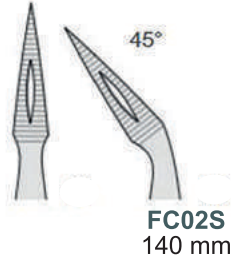
90
FC090
Üst Büyük Azı Sol
Upper Molars, Left



STIEGLITZ



FC01S
STIEGLITZ
140 mm



FC03S
STIEGLITZ
140 mm

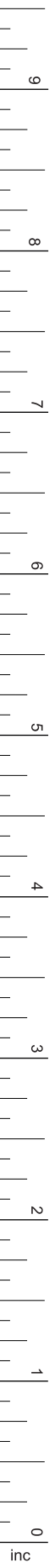
WITZEL



FC01W
Üst Kök
Upper Root
165 mm



FC02W
Alt Kök
Lower Root
160 mm



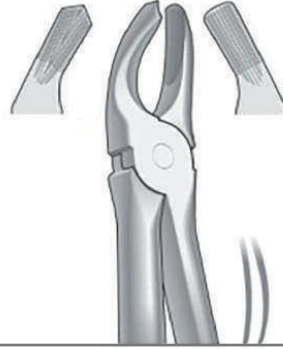
FC100



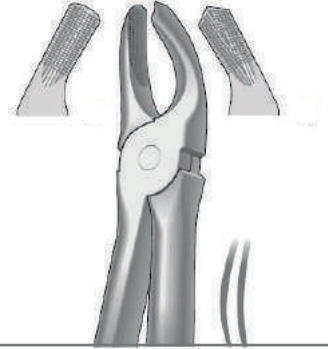
2
FC002
Üst Kesici
Upper Incisors



7
FC007
Üst Küçük Azı
Upper Premolar



17
FC017
Üst Büyük Azı Sağ
Upper Molar Right



18
FC018
Üst Büyük Azı Sol
Upper Molar Left



13
FC013
Alt Küçük Azı
Lower Premolar



22
FC022
Alt Büyük Azı
Lower Molar



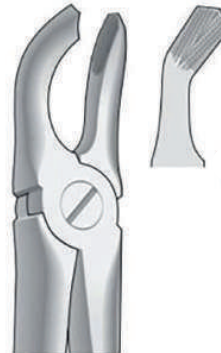
33
FC033
Alt Kesici ve Kök
Lower Incisors and Roots



51A
FC51A
Üst Kök
Upper Roots



67
FC067
Üst Üçüncü Azı
Lower Third Molar



79
FC079
Alt Üçüncü Azı
Lower Third Molar



22S
FC22S
Alt Molar
Lower Molars



123
FC123
Alt Kesici ve Kök
Lower Incisors and Root



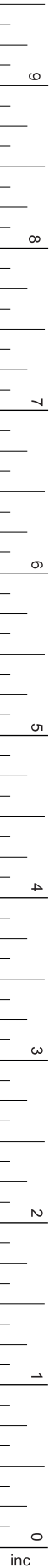
13S
FC13S
Alt Küçük Ağı
Lower Premolars



161
FC161
Alt Molar
Lower Molars



162
FC162
Alt Kök
Lower Roots





37
FC037
Üst Kesici
Upper Incisors



159
FC159
Üst Küçük Azı
Upper Premolars



39
FC039
Üst Büyük Azı
Upper Molars



39R
FC39R
Üst Büyük Azı Sağ
Upper Molars Right



39L
FC39L
Üst Büyük Azı Sol
Upper Molars Left



51S
FC51S
Üst Kök
Upper Roots

FC200



37
FC037
Üst Kesici
Upper Incisors



159
FC159
Üst Küçük Azı
Upper Premolar



39R
FC39R
Üst Büyük Azı Sağ
Upper Molar Right



39L
FC39L
Üst Büyük Azı Sol
Upper Molar Left



51S
FC51S
Üst Kök
Upper Roots



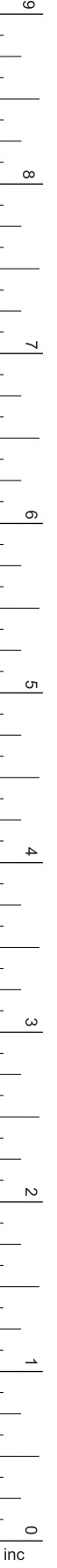
33S
FC33S
Alt Dişler ve Kök
Lower Teeth and Roots



13S
FC13S
Alt Küçük Azı
Lower Premolar



22S
FC22S
Alt Büyük Azı
Lower Molar





Türkiye'de ilk ve tek dental cerrahi el aleti yerli üretimi!

(The first and only teeth in Turkey domestic production of surgical hand tool)

- **81 ilde satış ve teknik servis hizmeti**
- Sales and technical services in 81 provinces
- **Satış öncesi, satış süresince ve satış sonrasında yüksek hizmet kalitesi**
- High service quality before, during and after sales
- **Global piyasalarda, lider pozisyonlarda, güçlü uluslararası ortaklıklara sahibiz**
- Global market leader we have strong international partnerships

İleri teknolojik ürünlerimizle hizmetinizdeyiz

Advanced technology
our products
We are at your service



ELEVATÖRLER
ELEVATORS





**Heidbrink
RT07H**
1,5 mm



**Heidbrink
RT08H**
2,5 mm

HEIDBRINK



RT01H
1.5 mm



RT02H
2.5 mm



RT05H
1.5 mm



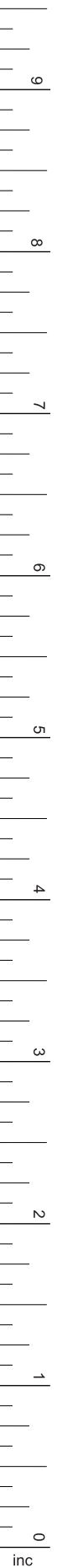
RT06H
2.5 mm

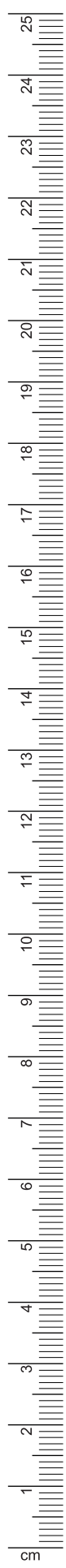


RT03H
2.5 mm



RT04H
1.5 mm





APICAL



RT02A
SOL / LEFT
155 mm / 2.5 mm



RT01A
DÜZ / FLAT
155 mm / 3 mm



RT03A
SAĞ / RIGHT
155 mm / 2.5 mm

APEXO



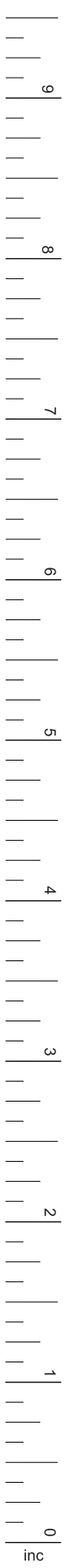
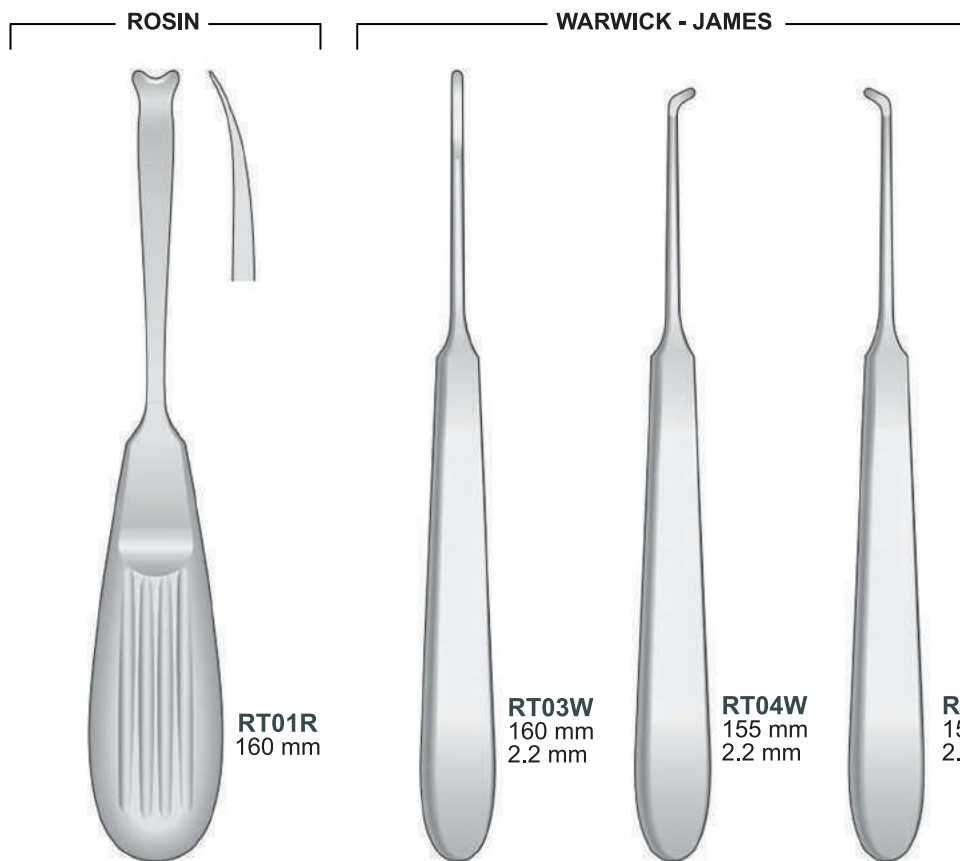
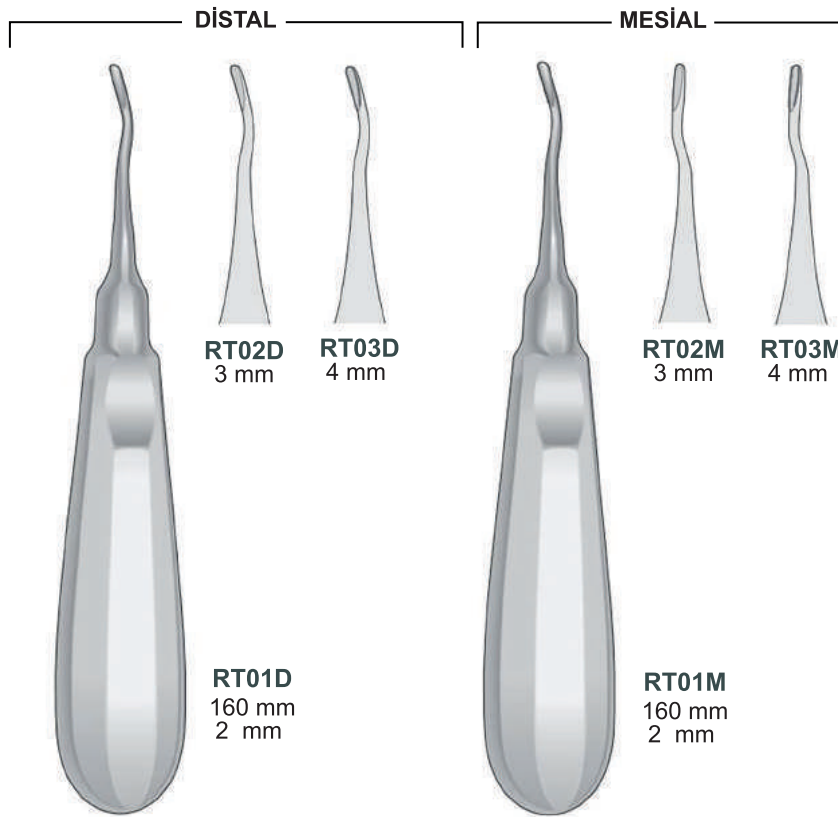
RT04A
160 mm
2,5 mm

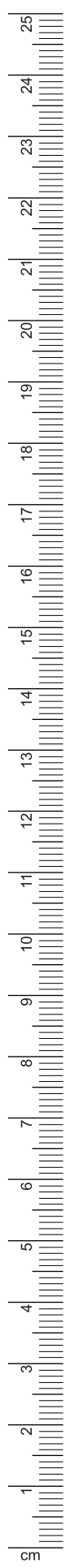
RT05A
160 mm
3 mm



RT06A
160 mm
2,5 mm

RT07A
160 mm
3 mm





LİNDÖ - LEVİAN | **KOPP**



LİNDÖ - LEVİAN
155 mm



RT01L
3 mm



RT02L
3.5 mm



RT03L
4 mm



RT01K
ÜST SOL
UPPER LEFT
3.6 mm

RT02K
ÜST SAĞ
UPPER RIGHT
3.6 mm

RT03K
ÜST SOL
UPPER LEFT
4.2 mm

RT04K
ÜST SAĞ
UPPER RIGHT
4.2 mm

RT05K
ALT SOL
LOWER LEFT
4.2 mm

RT06K
ALT SAĞ
LOWER RIGHT
4.2 mm

KRALLENHEBER



RT08K
SOL / LEFT
135 mm



RT07K
SAĞ / RIGHT
135 mm

FLOHR



RT01F
SOL / LEFT
150 mm
3 mm



RT03F
DÜZ / FLAT
150 mm
3 mm



RT02F
SAĞ / RIGHT
150 mm
3 mm

CRYER



RT01C / RT02C
155 mm



RT01C
SOL
LEFT



RT02C
SAĞ
RIGHT

SELDİN



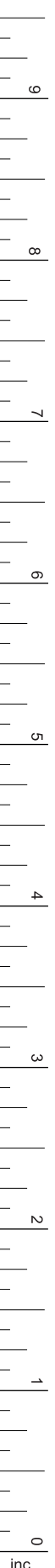
RT01S / RT02S
160 mm



RT01S
SOL
LEFT



RT02S
SAĞ
RIGHT



HYLİN



DÜZ / FLAT
145 mm



RT10H
4 mm



RT11H
2 mm



RT12H
3 mm



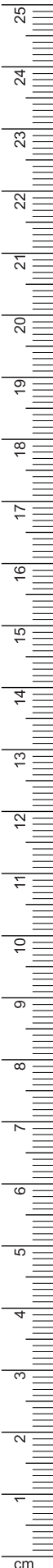
RT09H
3 mm



RT13H
SOL / LEFT
3 mm



RT14H
SAĞ / RIGHT
3 mm



COUPLAND



RT03C
DÜZ / FLAT
3 mm



RT04C
DÜZ / FLAT
3.6 mm



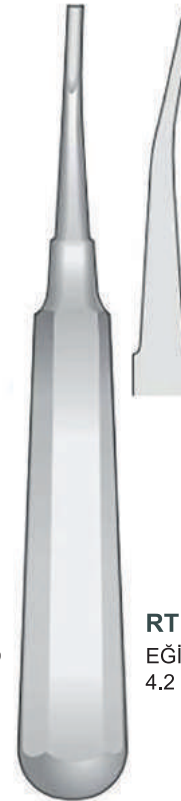
RT05C
DÜZ / FLAT
4.2 mm



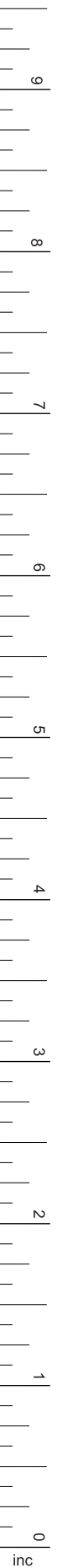
RT13C
EĞİK / THRESHOLD
3 mm



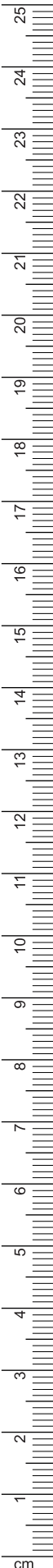
RT14C
EĞİK / THRESHOLD
3.6 mm



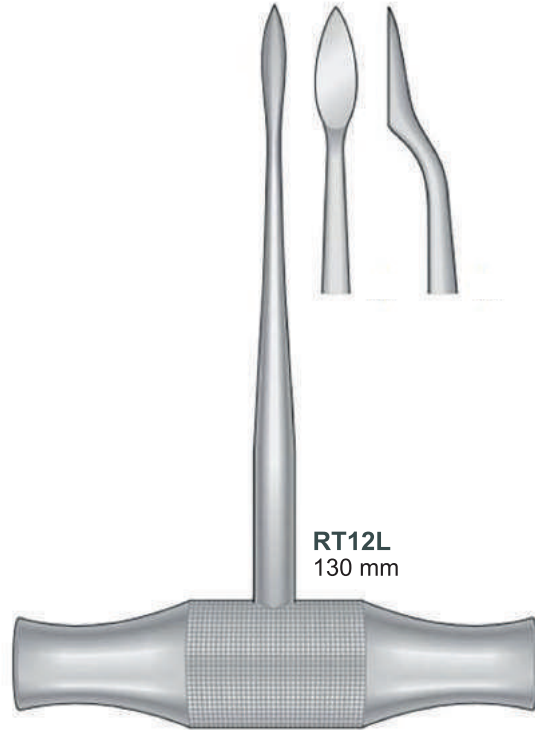
RT15C
EĞİK / THRESHOLD
4.2 mm



WINTER

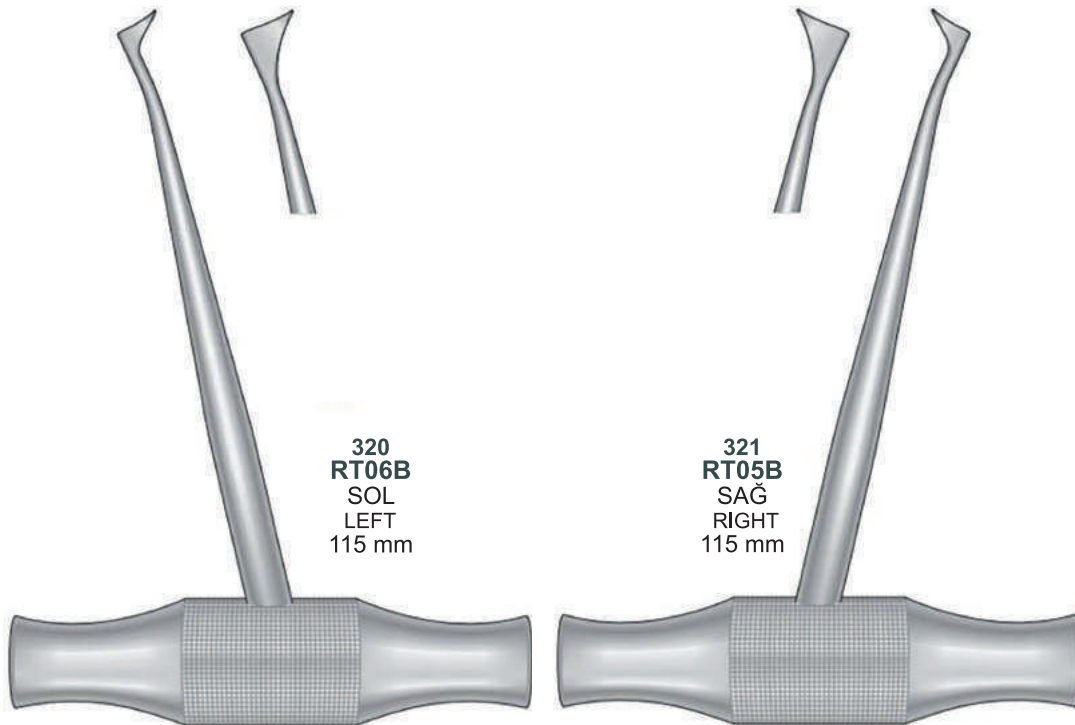


LECLUSE



RT12L
130 mm

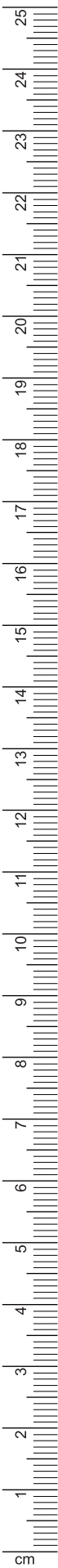
BARRY



320
RT06B
SOL
LEFT
115 mm

321
RT05B
SAĞ
RIGHT
115 mm





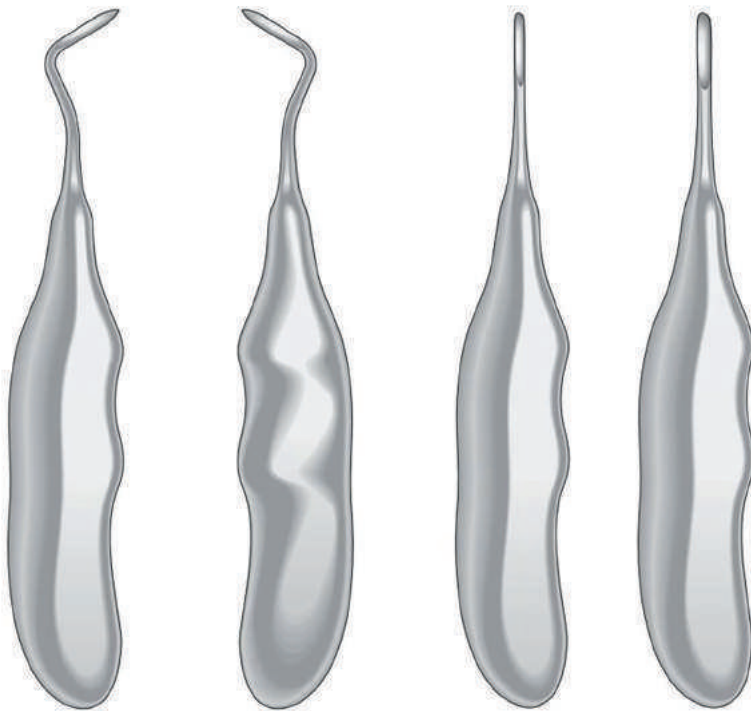
ANATOMIC HANDLE



RT05T

RT06T

RT07T



RT01T

RT02T

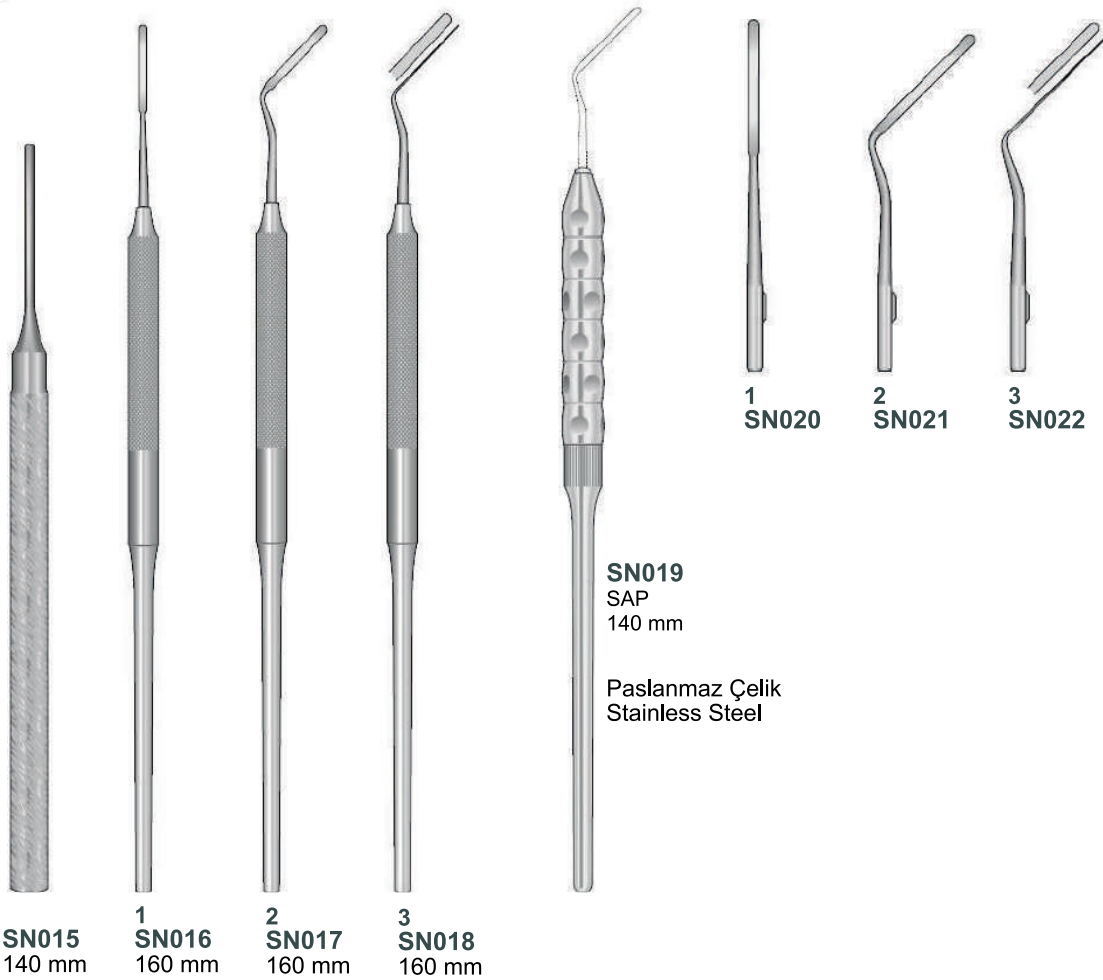
RT03T

RT04T



SN001
125 mm

PERİOTOMLAR / PERİOTOMES



SN019
SAP
140 mm

Paslanmaz Çelik
Stainless Steel

SN015
140 mm

1 SN016
160 mm

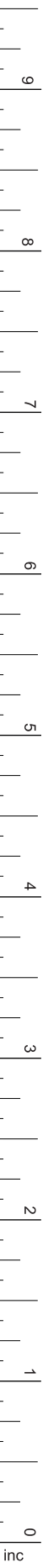
2 SN017
160 mm

3 SN018
160 mm

1 SN020

2 SN021

3 SN022





CHOMPRET
SN023
150 mm



CHOMPRET
SN024
150 mm



CHOMPRET
SN025
150 mm



CHOMPRET
SN026
145 mm



CHOMPRET
SN027
165 mm



CHOMPRET
SN028
165 mm



CHOMPRET
SN029
165 mm



CHOMPRET
SN030
160 mm



**BENNETT
PR001**
175 mm



PR002
175 mm



**PRICHARD
PR003**
180 mm



**PRICHARD
PR004**
175 mm



PR005
185 mm

Ø 2 mm



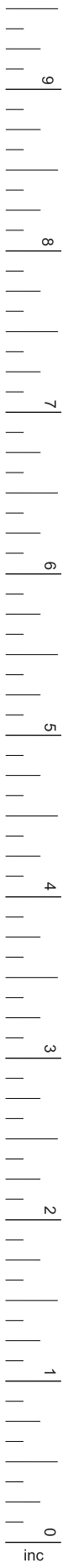
**MOLT
PR006**
170 mm

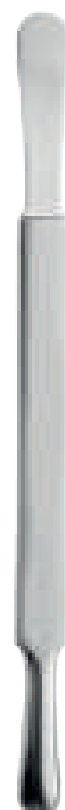
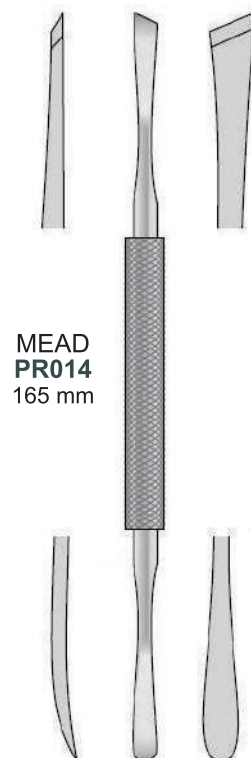
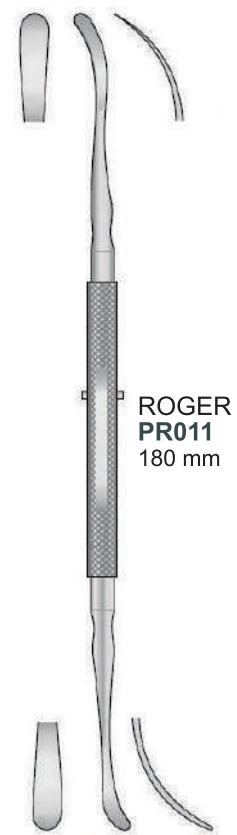
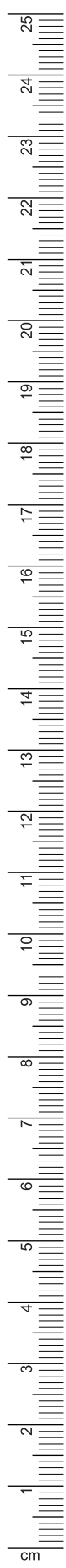


PR007
200 mm



**MENEGHINI
PR008**
180 mm



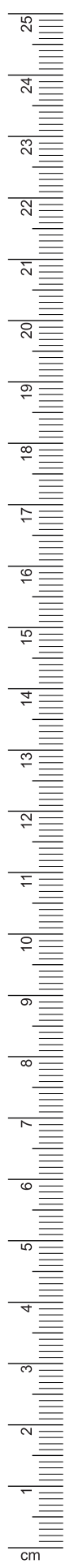


**SELDIN
PR015
190 mm**



MAKASLAR
SCISSORS





CS008
145 mm

CASTROVIEJO



CS009
145 mm

CASTROVIEJO



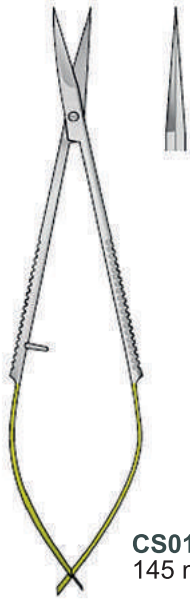
CS010
185 mm

CASTROVIEJO



CS011
185 mm

CASTROVIEJO



CS012
145 mm

CASTROVIEJO **TC**



CS013
145 mm

CASTROVIEJO **Tİ**



CS014
145 mm

CASTROVIEJO **TC**



CS015
145 mm

CASTROVIEJO **Tİ**



CS016
185 mm

CASTROVIEJO **TC**



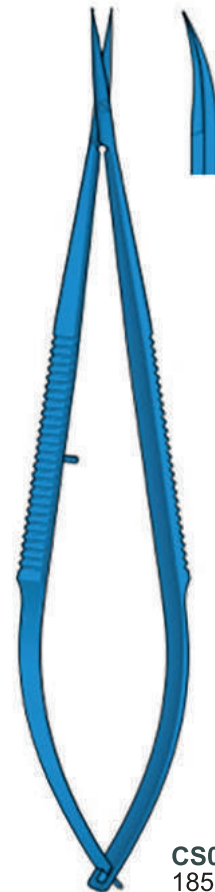
CS017
185 mm

CASTROVIEJO **Tİ**



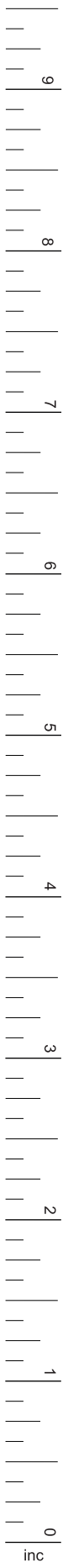
CS018
185 mm

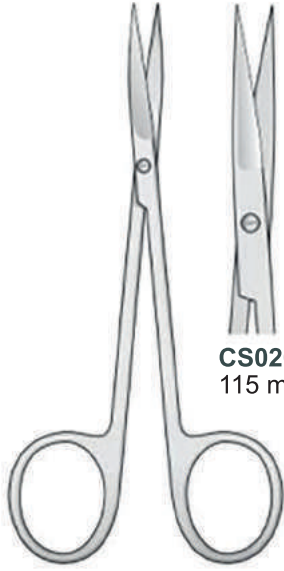
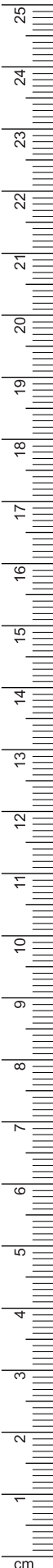
CASTROVIEJO **TC**



CS019
185 mm

CASTROVIEJO **Tİ**





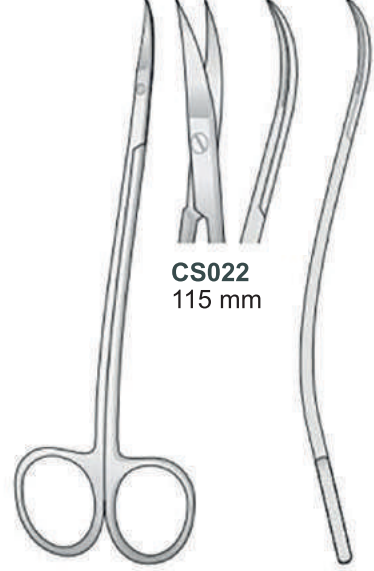
IRIS



CS020
115 mm



CS021
115 mm



LA GRANGE

CS022
115 mm



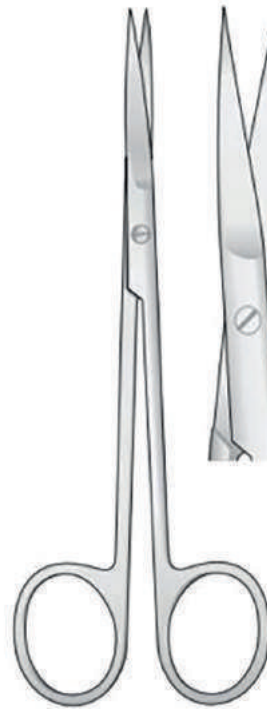
GOLDMAN-FOX



CS023
130 mm



CS024
130 mm



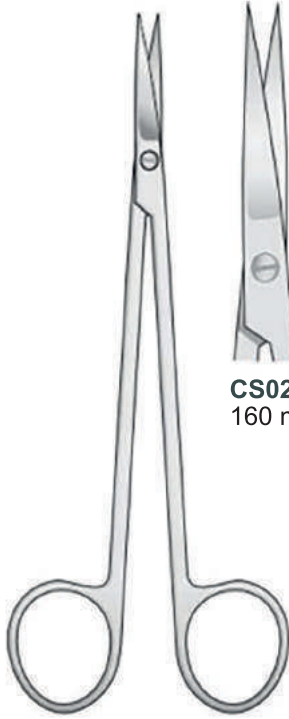
JOSEPH



CS025
150 mm



CS026
150 mm



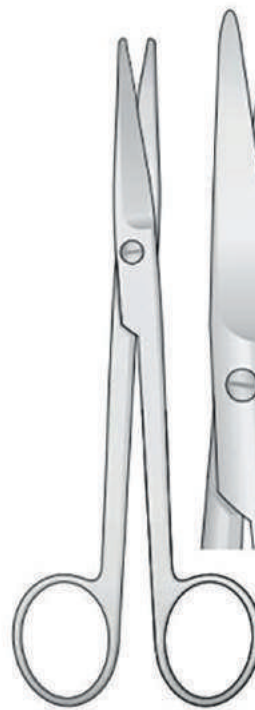
KELLY



CS027
160 mm



CS028
160 mm



MAYO



CS029
140 mm



CS030
140 mm



STEVENS



CS031
110 mm

Sivri
Sharp



CS032
110 mm

Sivri
Sharp



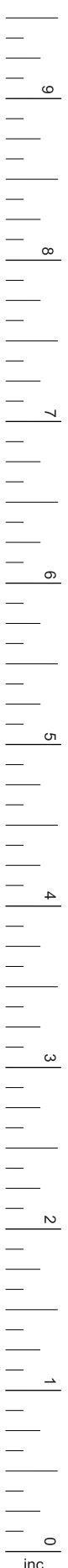
CS033
110 mm

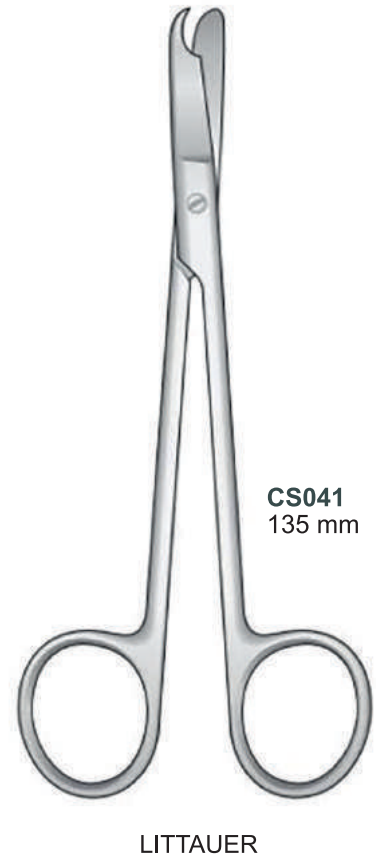
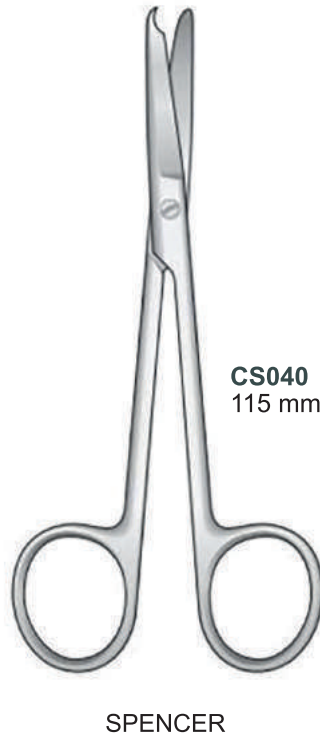
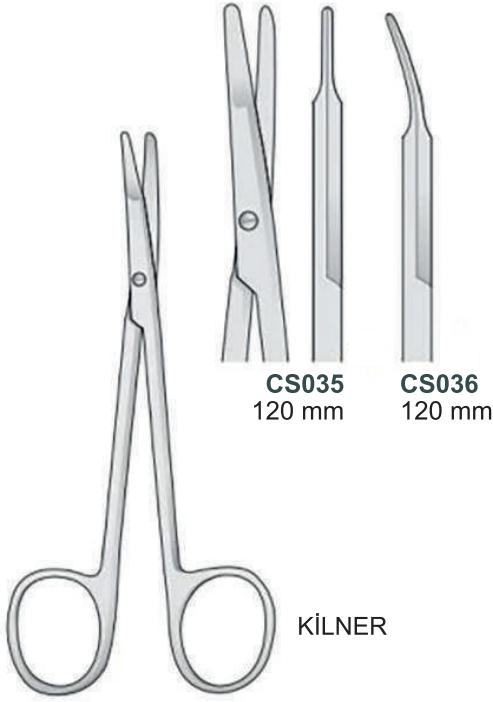
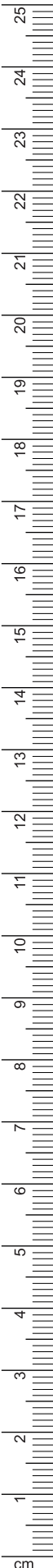
Künt
Blunt



CS034
110 mm

Künt
Blunt







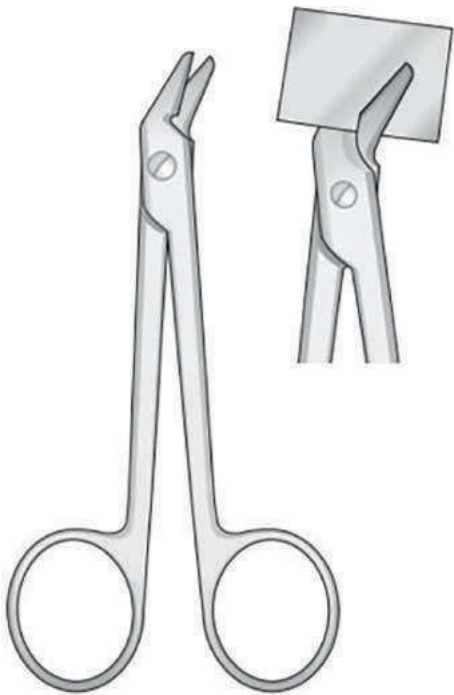
KLINKENBERGH-LOTH
CS042
230 mm



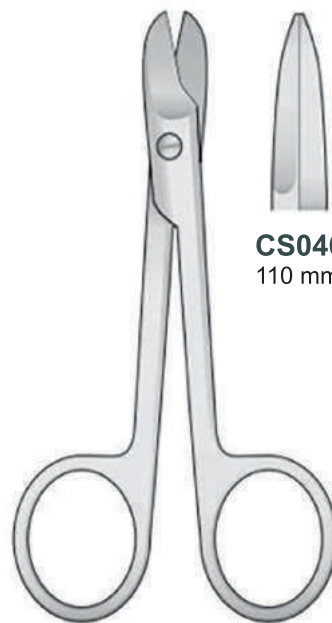
STRULLY
CS043
230 mm



SATINSKY
CS044
245 mm



CS045
120 mm



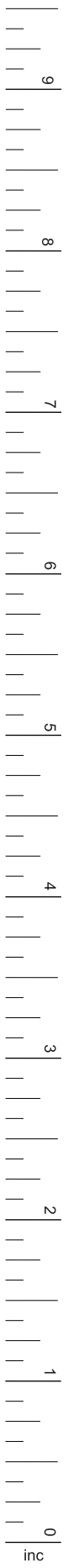
BEEBE



CS046
110 mm



CS047
110 mm





STANDART



CS048
130 mm

Künt / Blunt



STANDART TC

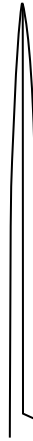


CS049
140 mm

Künt / Blunt
Sivri / Sharp



STANDART SC



CS050
140 mm

Künt / Blunt
Sivri / Sharp

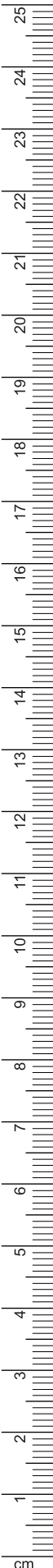


STANDART



CS051

Künt / Blunt
Sivri / Sharp





CS052
140 mm

Künt / Blunt
Sivri / Sharp

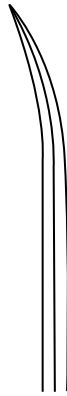
STANDART



CS053
120 mm

Künt / Blunt
Sivri / Sharp

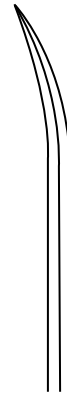
STANDART



CS054
160 mm

Künt / Blunt
Sivri / Sharp

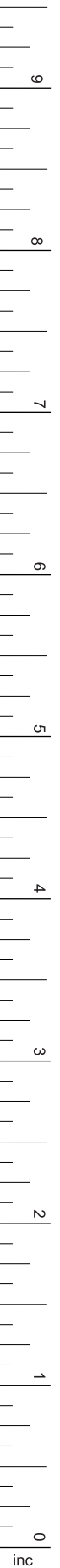
STANDART

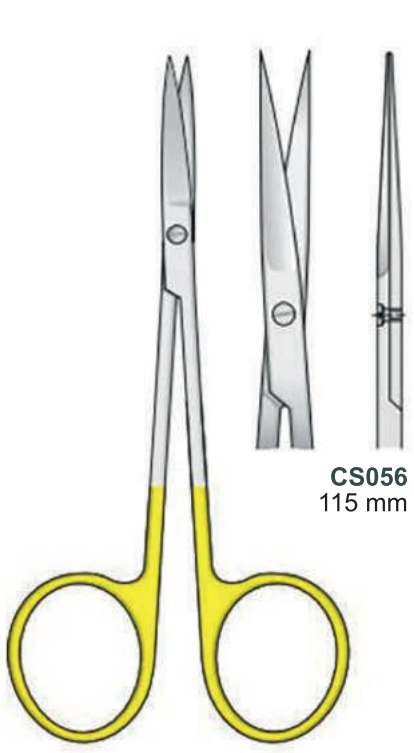
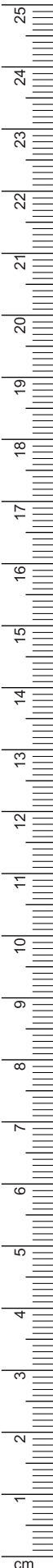


CS055
180 mm

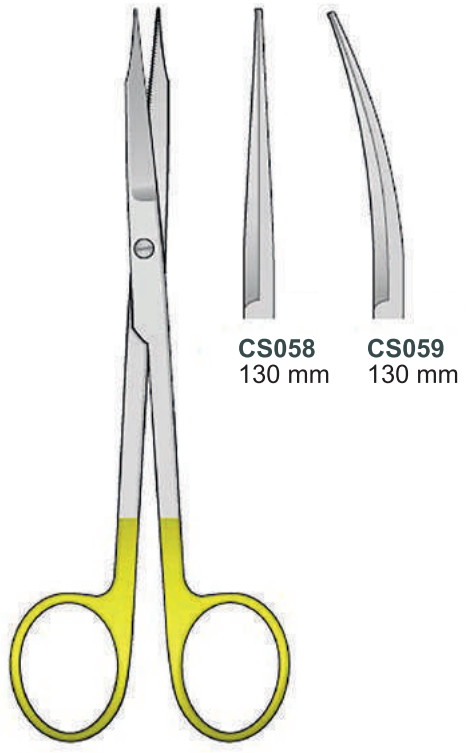
Künt / Blunt
Sivri / Sharp

STANDART

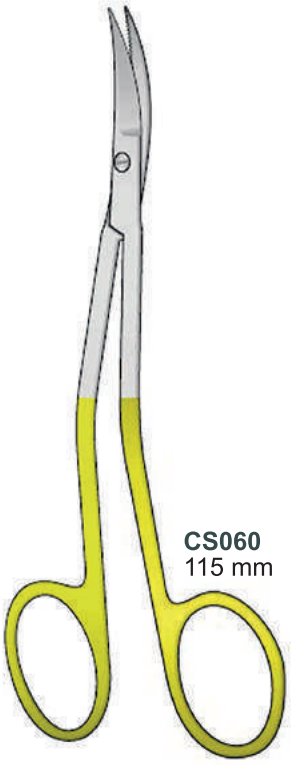




İRİS TC



GOLDMAN-FOX TC



LA GRANGE TC



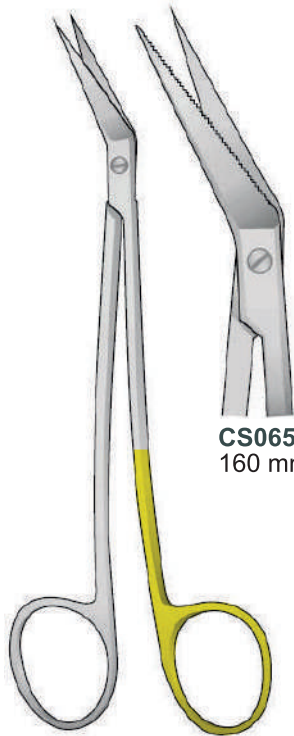
METZENBAUM TC



IRIS **SC**

CS063
115 mm

CS064
115 mm



LOCKLIN **SC**

CS065
160 mm

CS066
160 mm



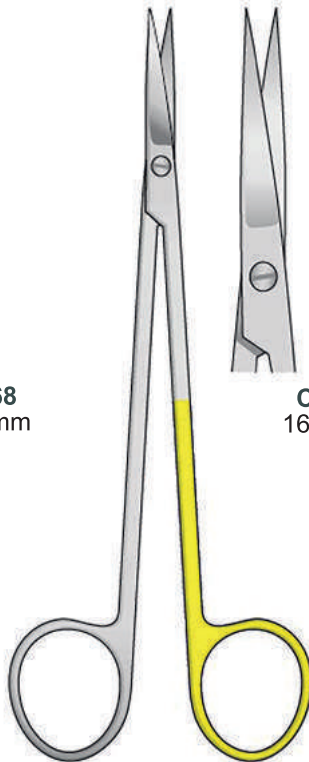
LOCKLIN **SC**



GOLDMAN-FOX **SC**

CS067
130 mm

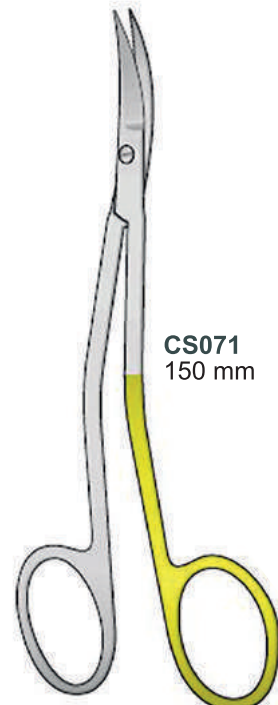
CS068
130 mm



KELLY **SC**

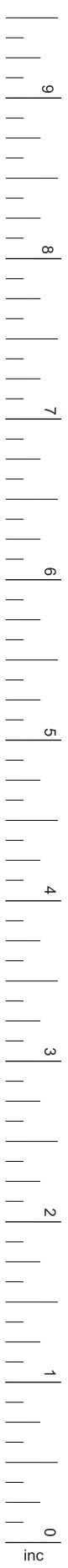
CS069
160 mm

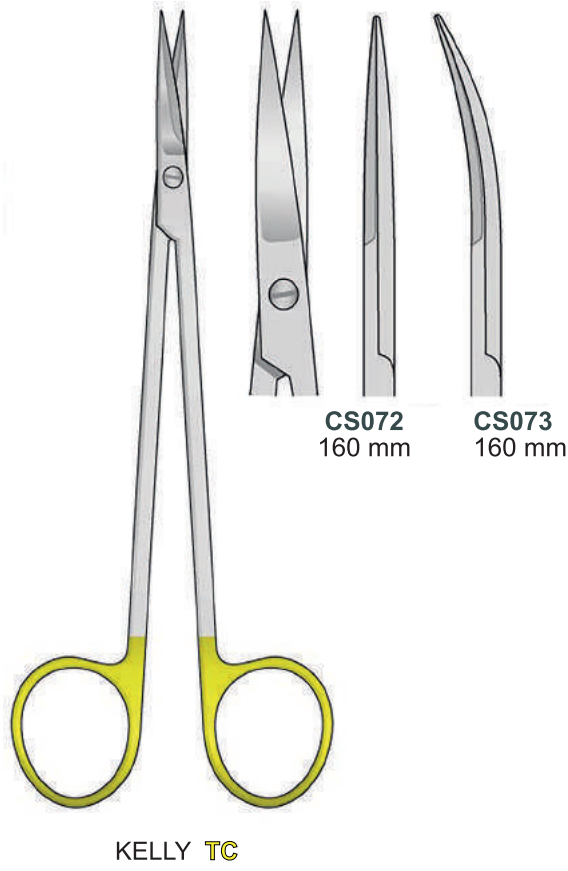
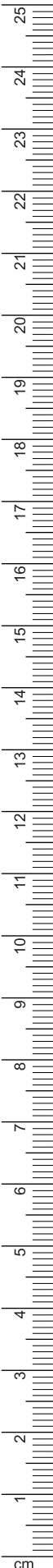
CS070
160 mm



LA GRANGE **SC**

CS071
150 mm



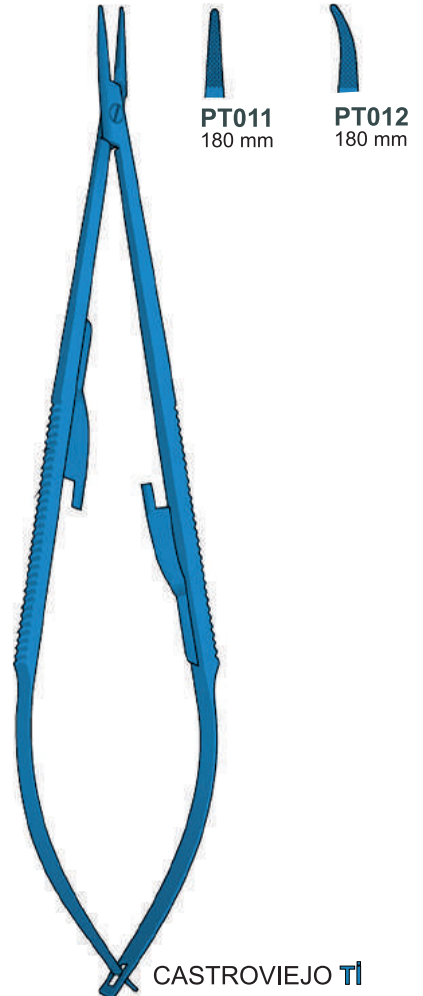
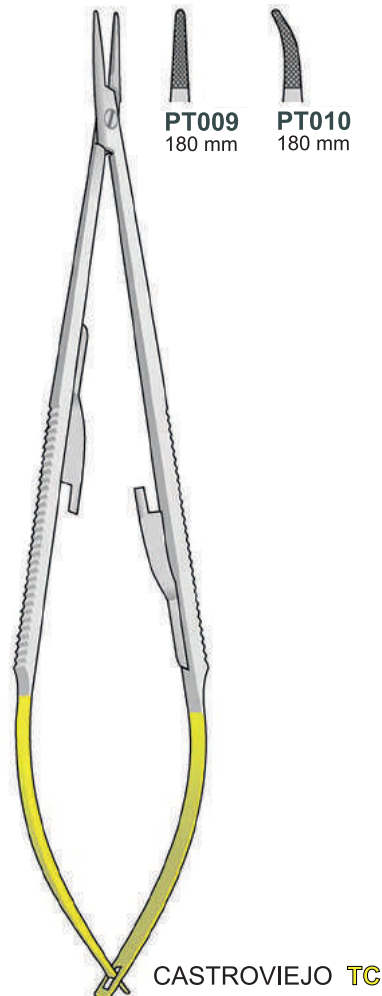
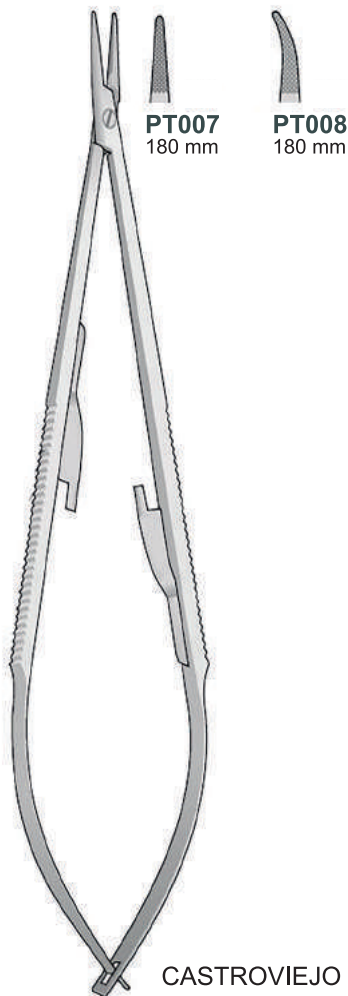
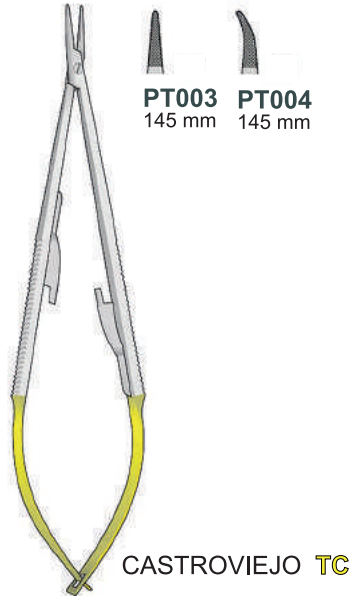
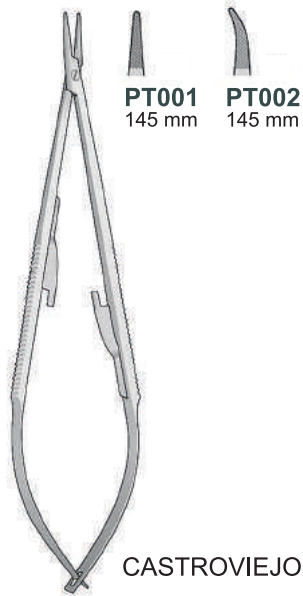
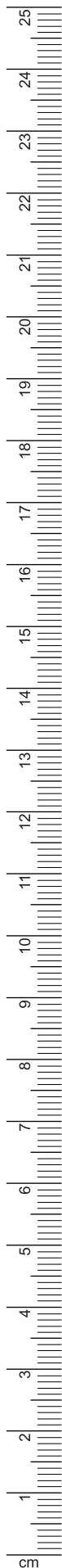


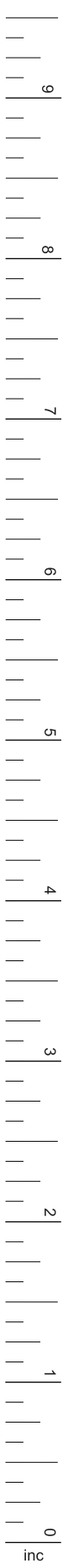
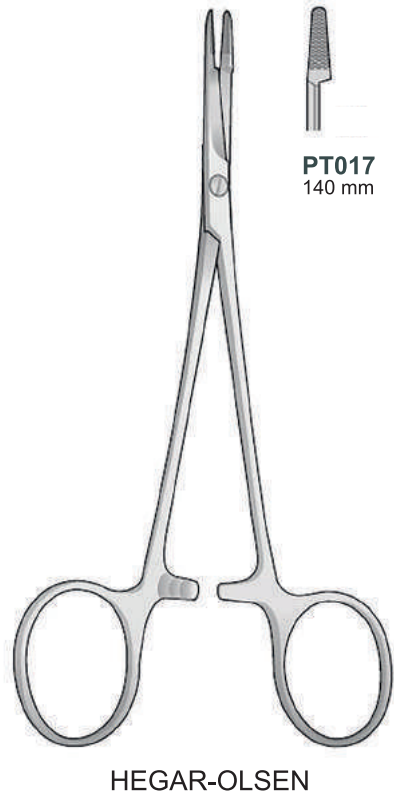
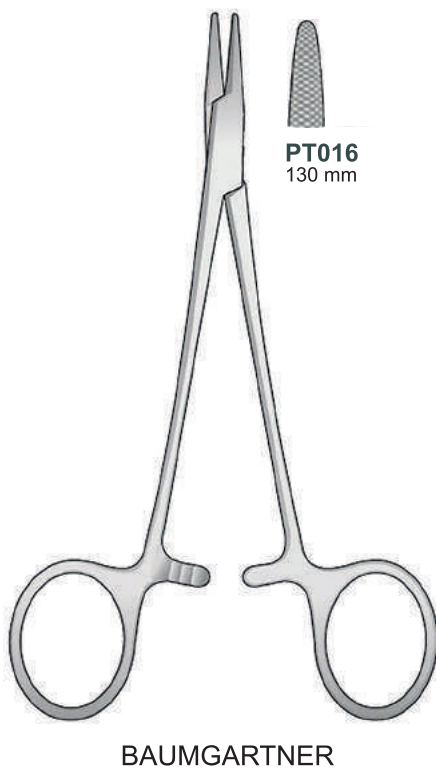
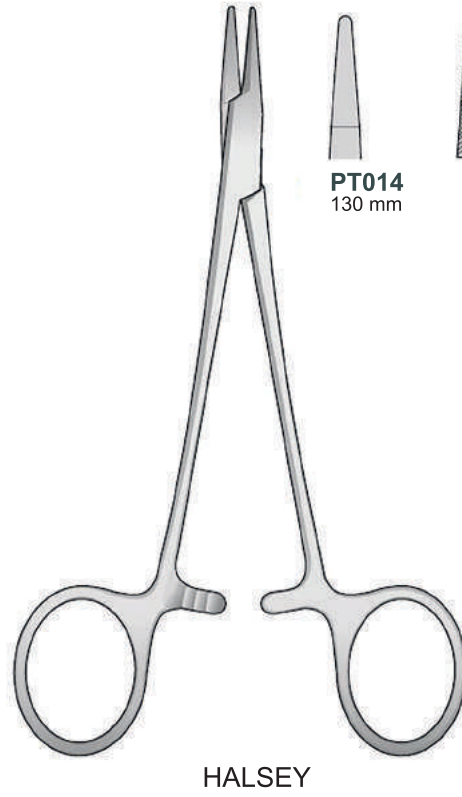
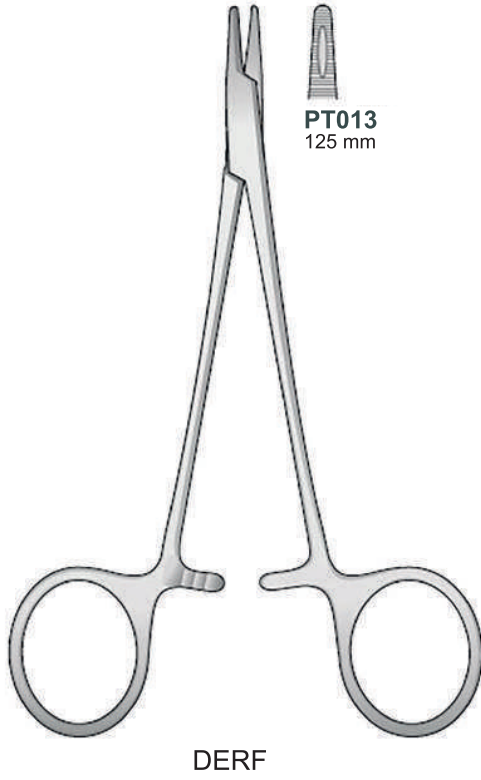


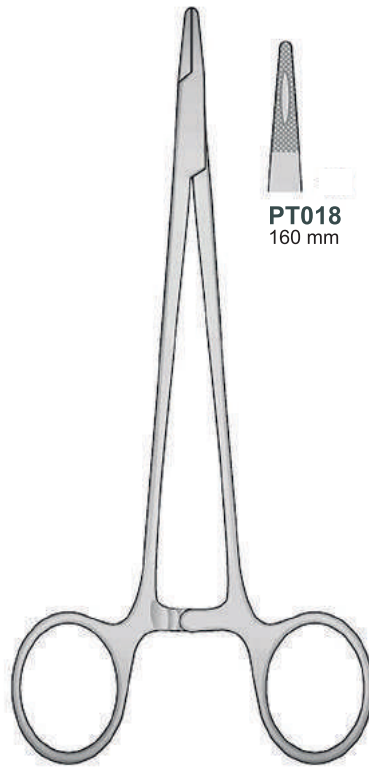
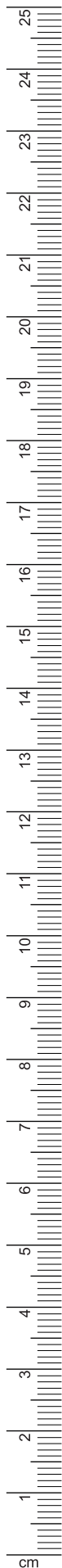
PORTEGÜLER
NEEDLE HOLDERS



PORTEGÜLER
NEEDLE HOLDERS



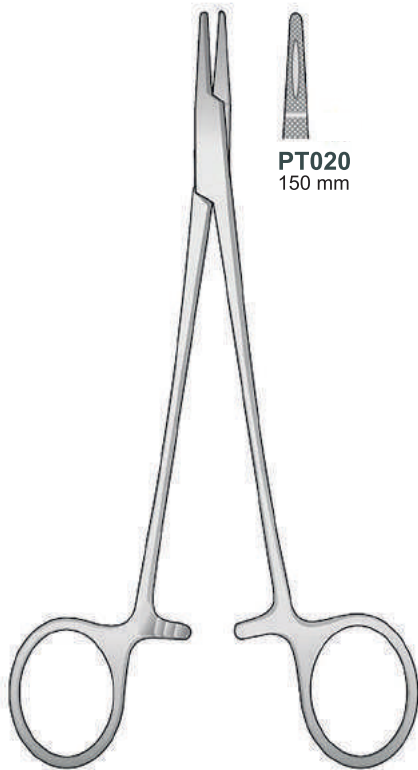




PT018
160 mm

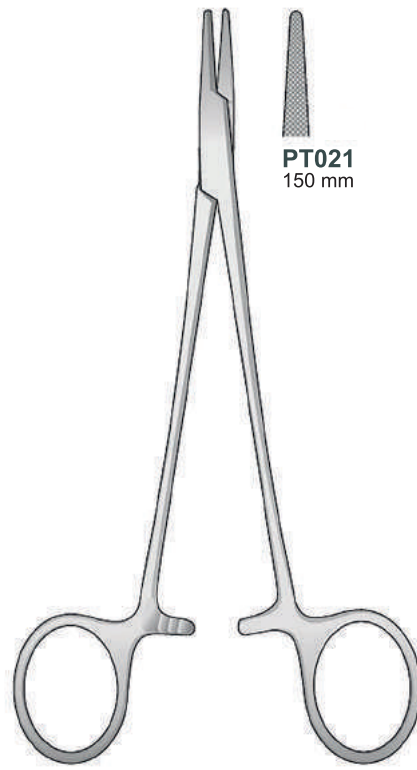
PT019
180 mm

MAYO-HEGAR



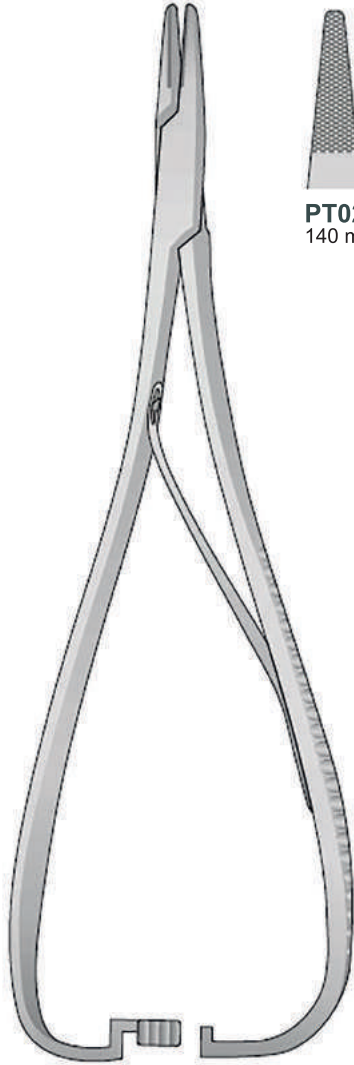
PT020
150 mm

CRILE WOOD

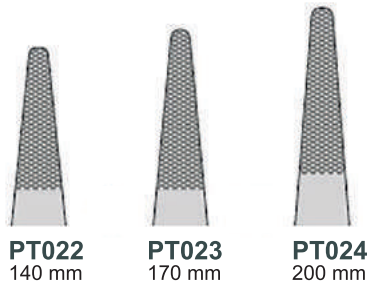


PT021
150 mm

CRILE MURRAY



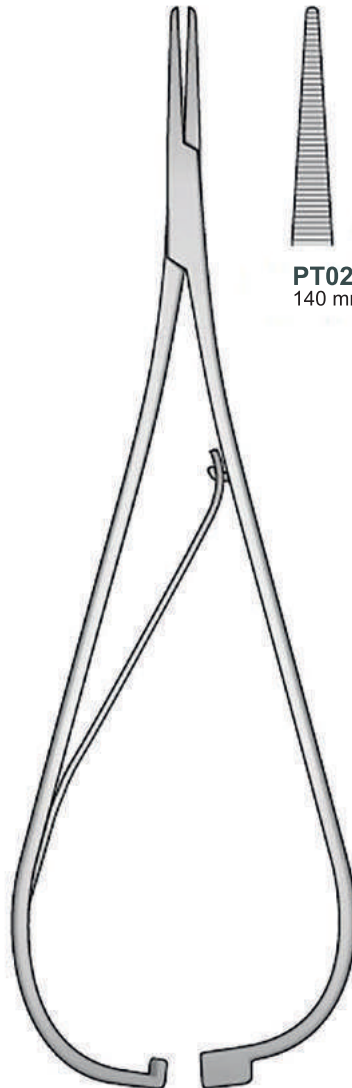
MATHIEU



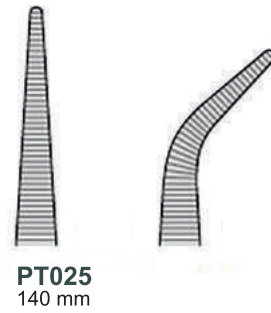
PT022
140 mm

PT023
170 mm

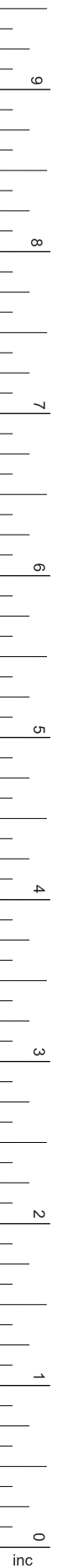
PT024
200 mm

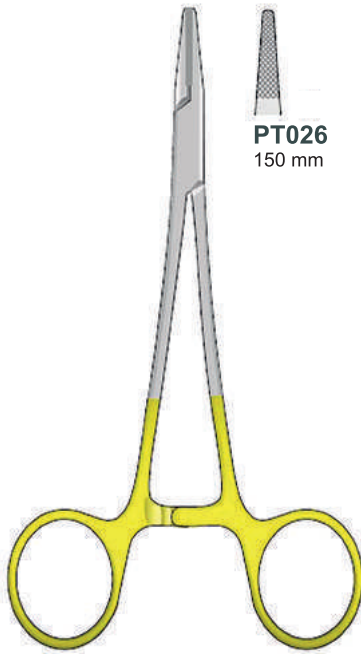
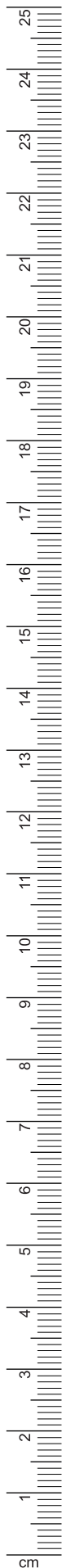


SMAHA



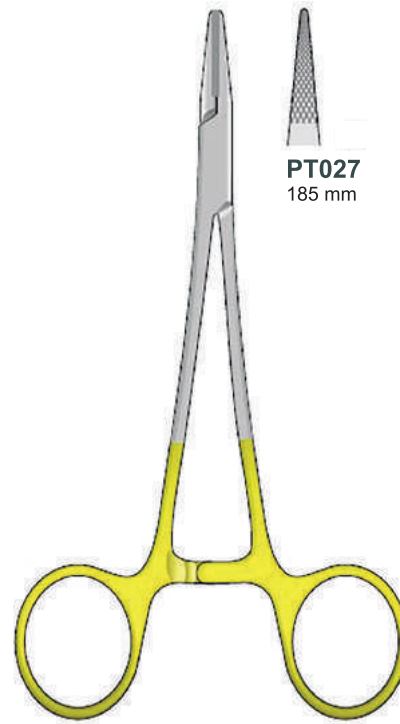
PT025
140 mm





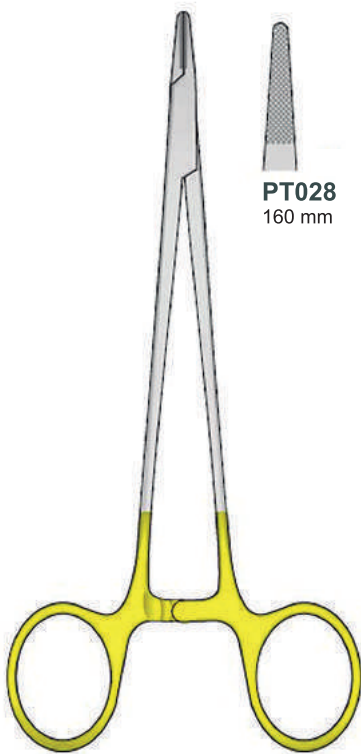
PT026
150 mm

BABY-CRILE-WOOD TC



PT027
185 mm

CRILE-WOOD TC

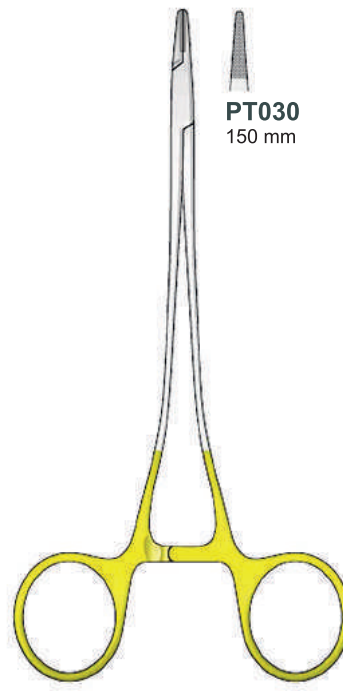


PT028
160 mm

MAYO-HEGAR TC

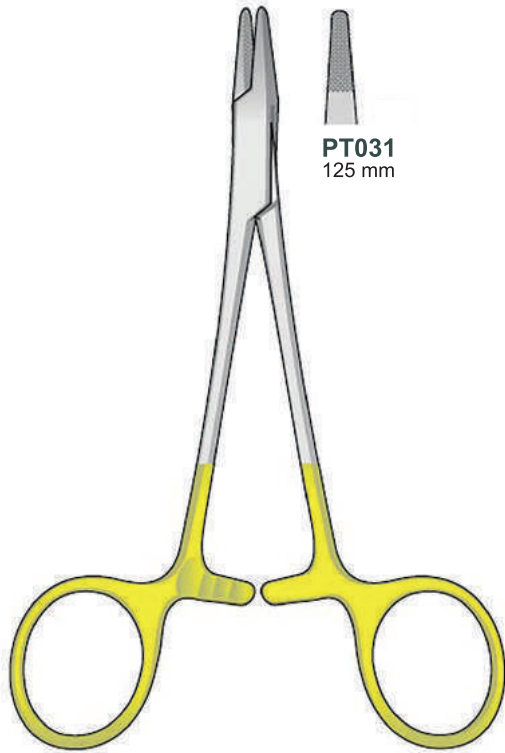


PT029
180 mm



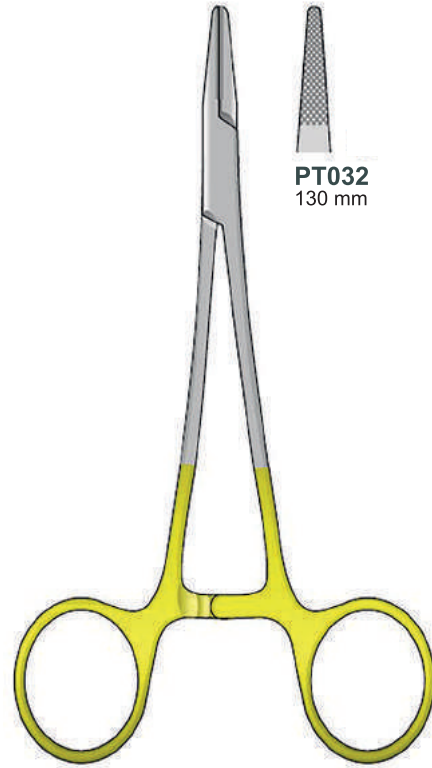
PT030
150 mm

FINE SWEDISH TC



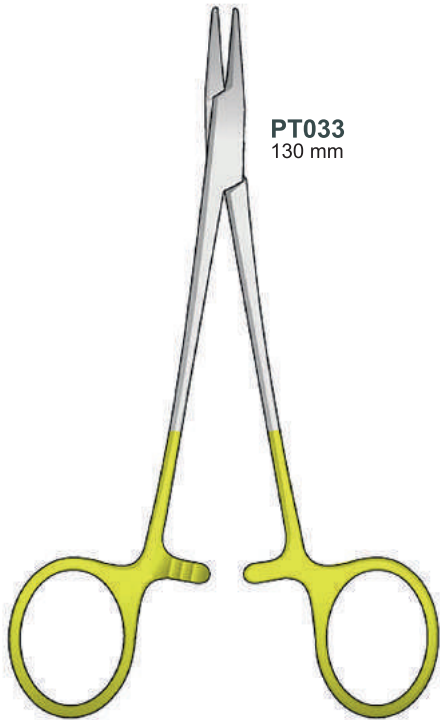
PT031
125 mm

DERF TC



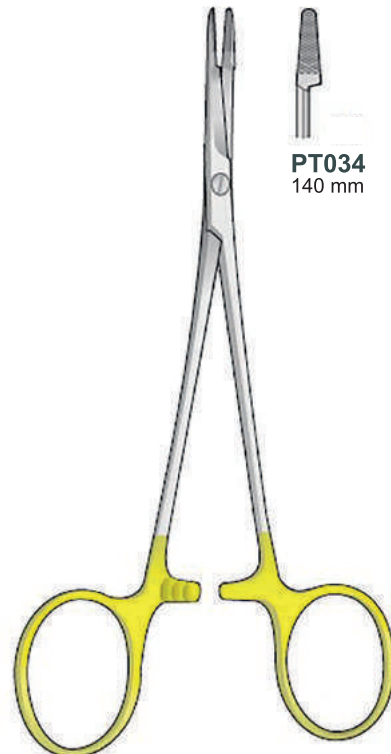
PT032
130 mm

HALSEY TC



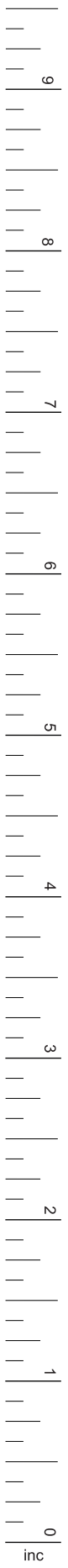
PT033
130 mm

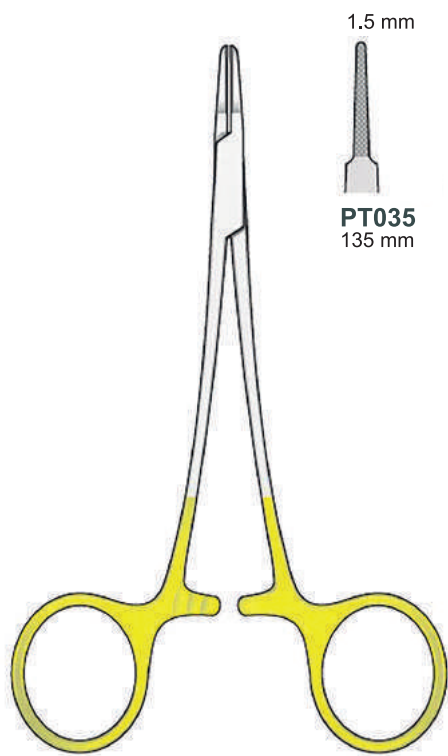
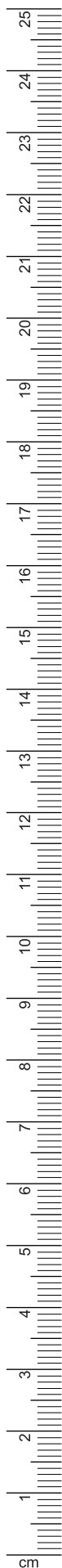
BAUMGARTNER TC



PT034
140 mm

HEGAR-OLSEN TC





RYDER TC

1.5 mm



PT035
135 mm

1.5 mm



PT036
155 mm

1.5 mm

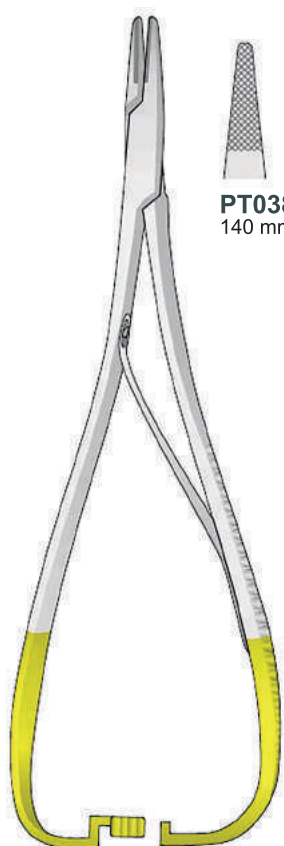


PT037
175 mm



GILLIES TC

PT041
160 mm



MATHIEU TC



PT038
140 mm



PT039
170 mm

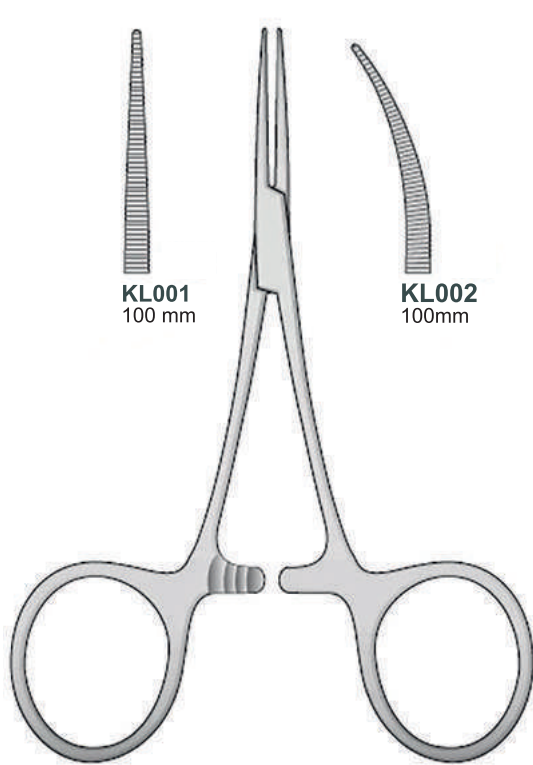
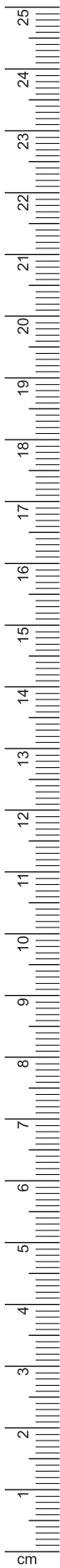


PT040
200 mm

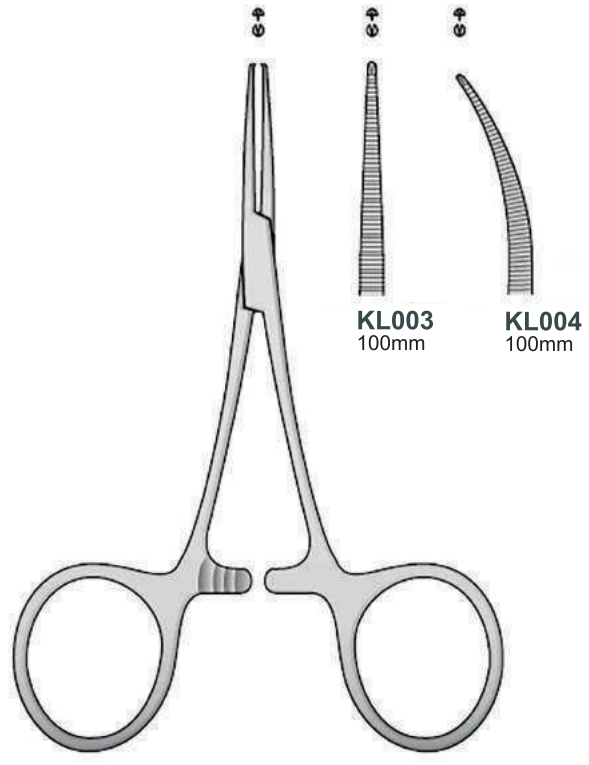


KLEMPLER
FORCEPS

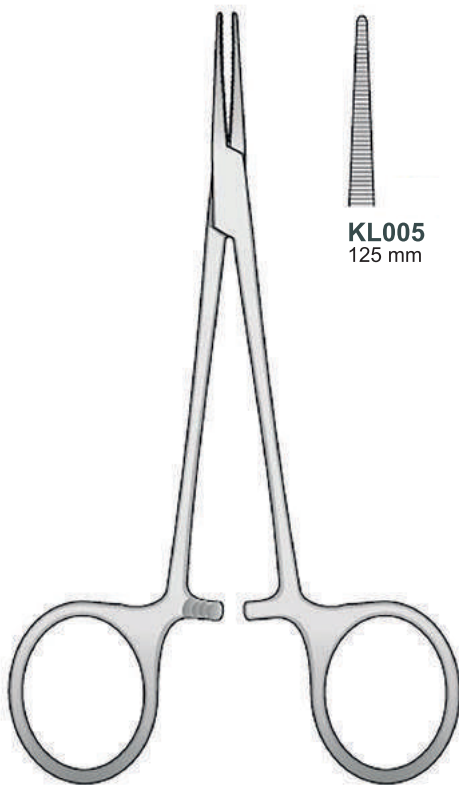




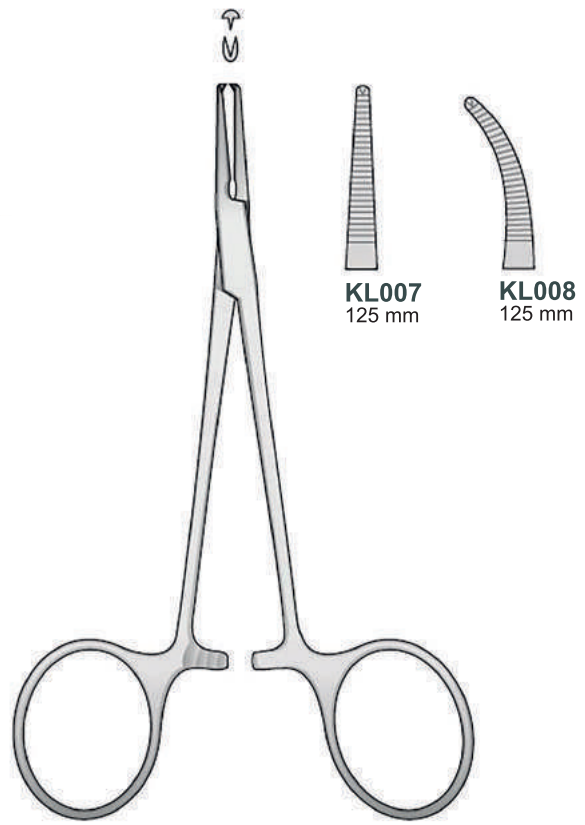
BABY-MOSQUITO



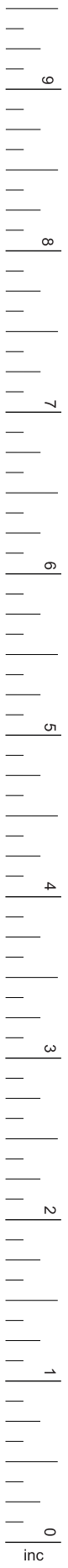
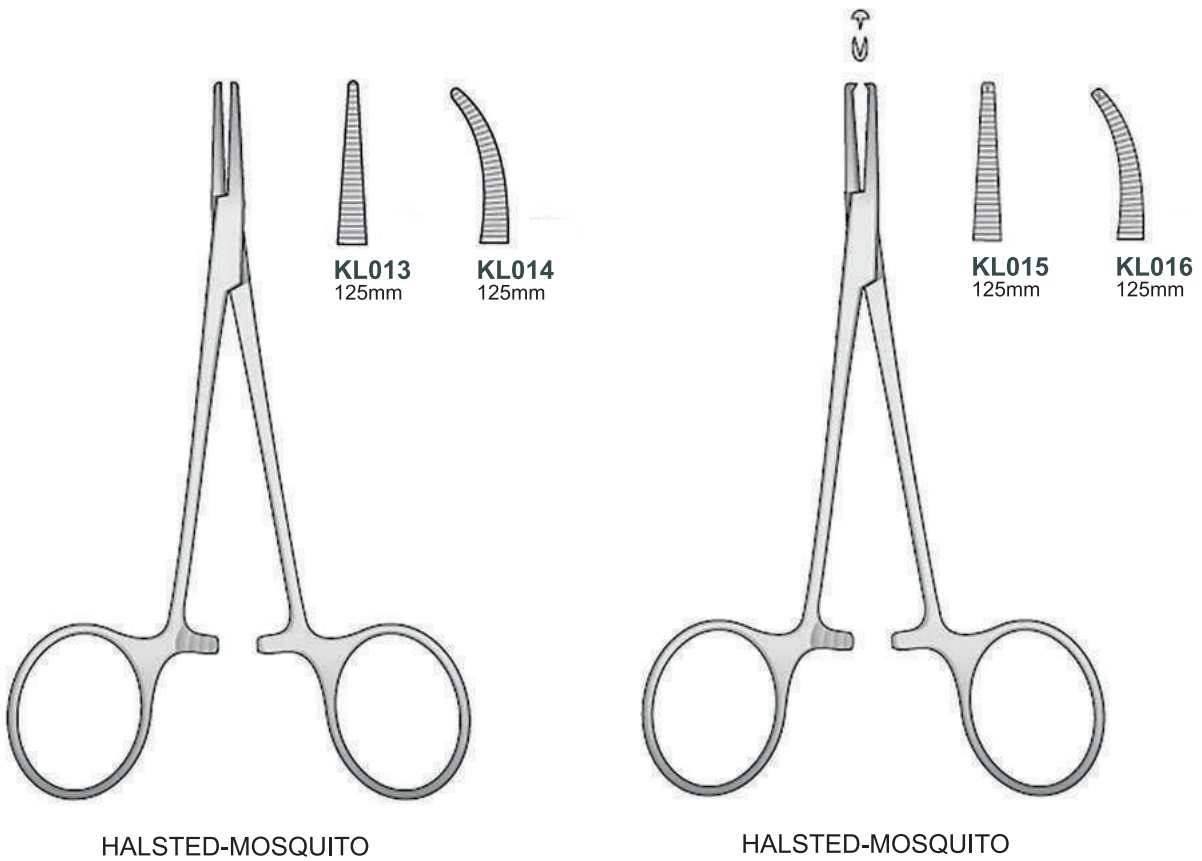
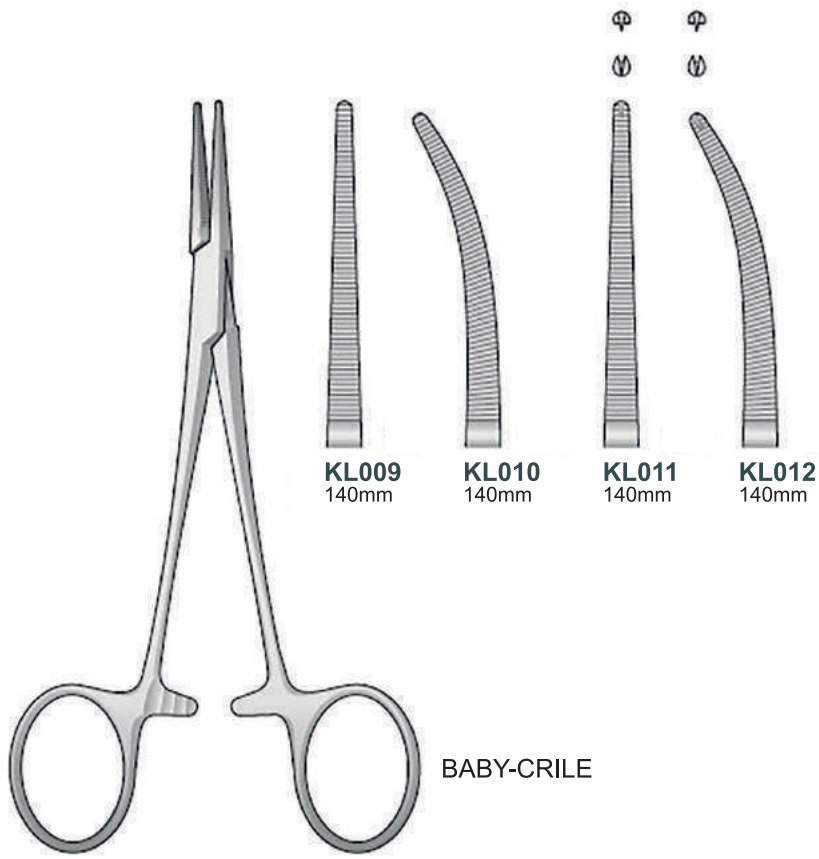
BABY-MOSQUITO

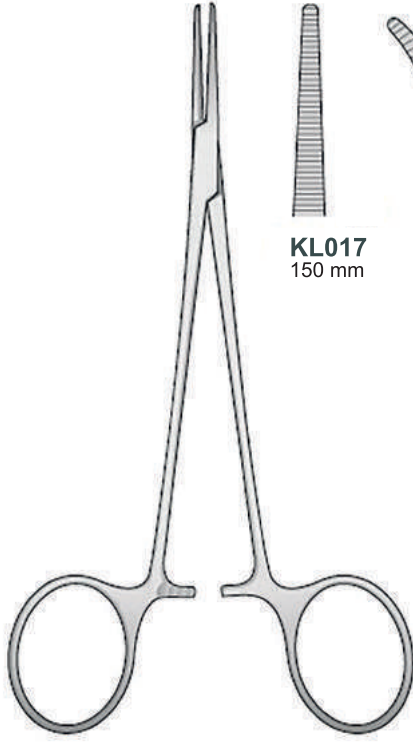
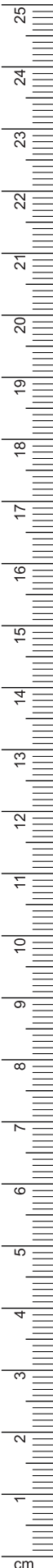


MICRO-HALSTED



MICRO-HALSTED





LERICHE

KL017
150 mm

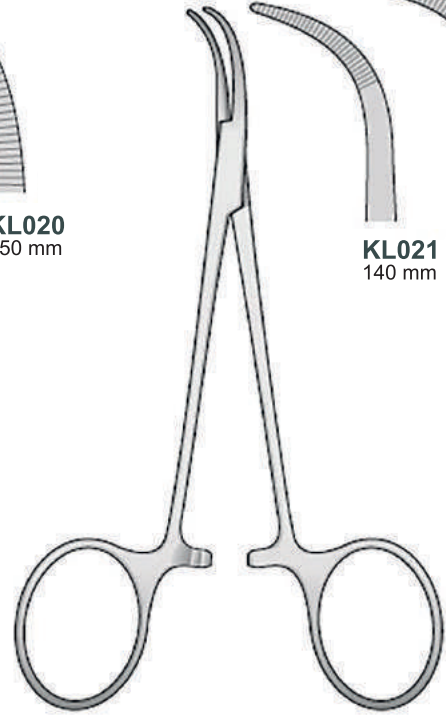
KL018
150 mm

KL019
150 mm

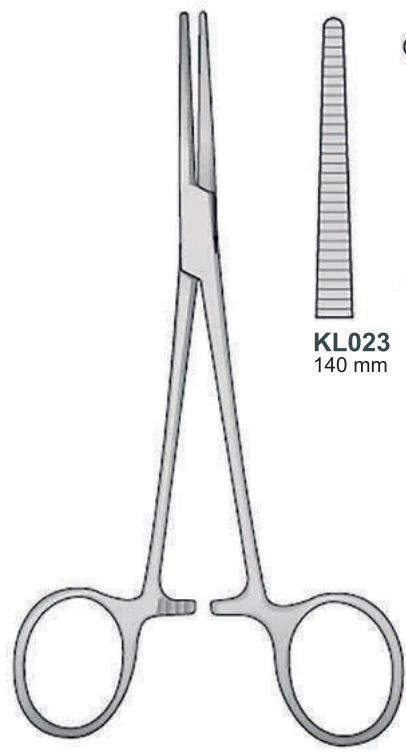
KL020
150 mm

KL021
140 mm

KL022
180 mm



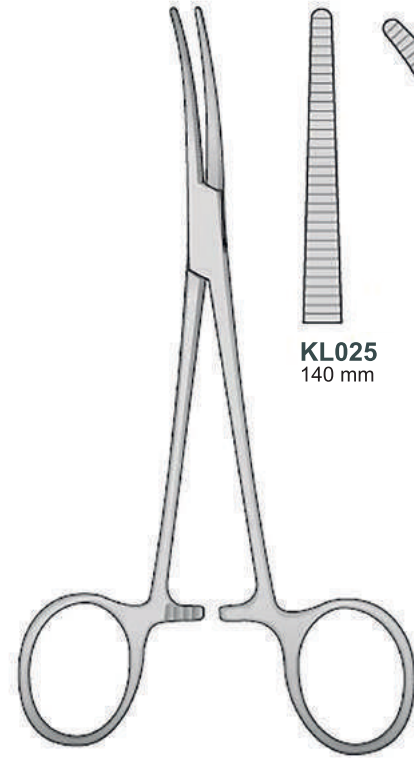
BABY-MIXTER



CRILE

KL023
140 mm

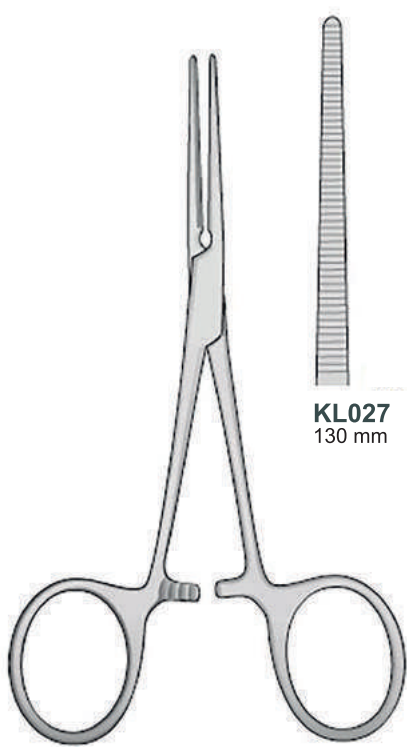
KL024
140 mm



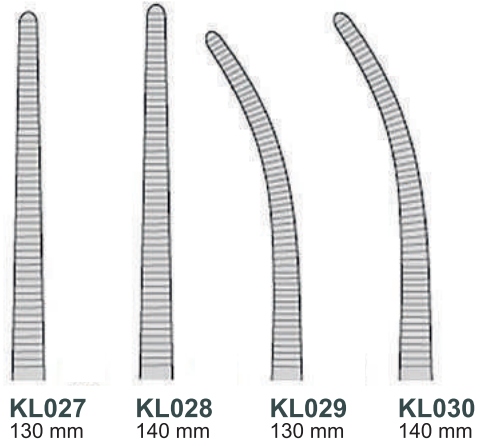
CRILE

KL025
140 mm

KL026
140 mm



PEAN



KL027
130 mm

KL028
140 mm

KL029
130 mm

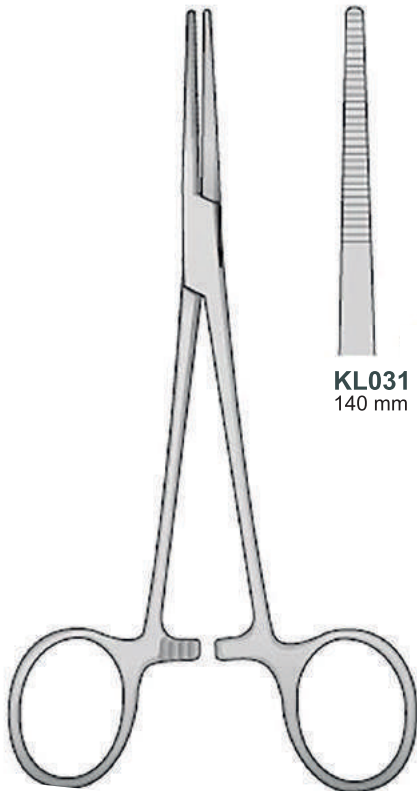
KL030
140 mm



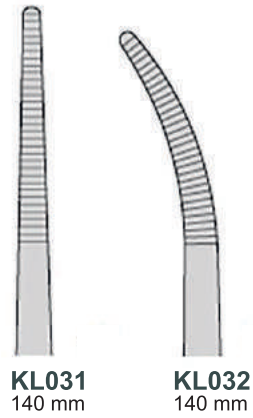
SCHAEDEL
KL053
85 mm



JONES
KL054
85 mm

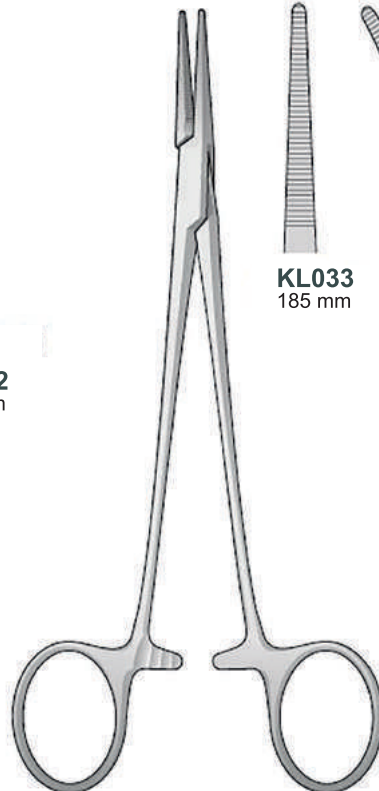


KELLY

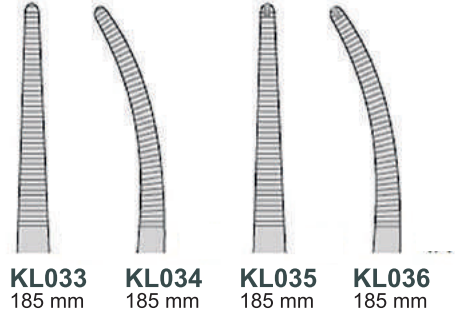


KL031
140 mm

KL032
140 mm



HALSTED



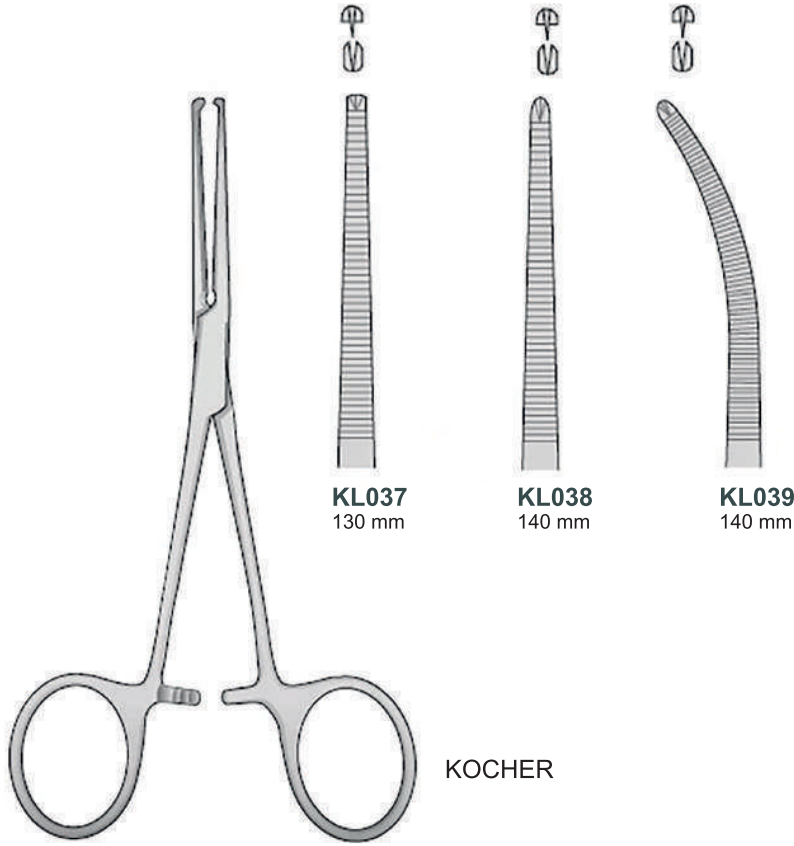
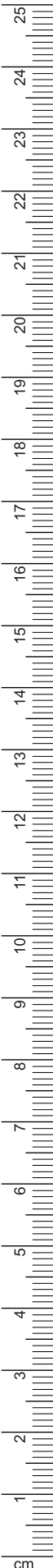
KL033
185 mm

KL034
185 mm

KL035
185 mm

KL036
185 mm





KL037
130 mm

KL038
140 mm

KL039
140 mm

KOCHER



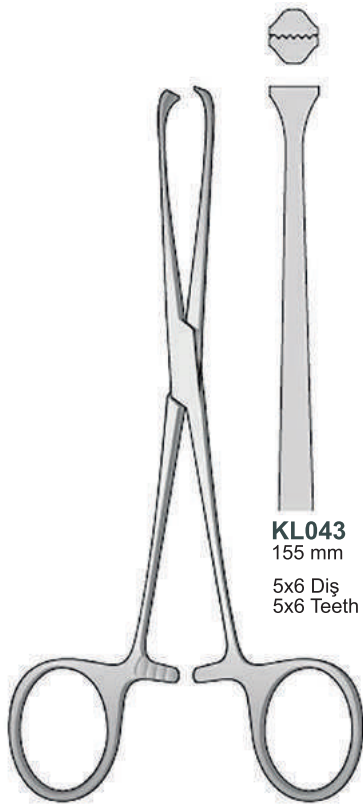
KL040
130 mm
4x5 Diş
4x5 Teeth

KL041
155 mm
5x6 Diş
5x6 Teeth

KL042
155 mm
5x6 Diş
5x6 Teeth

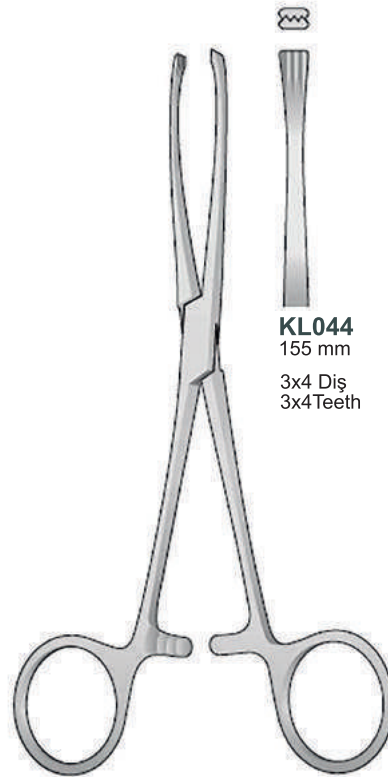
BABY ALLIS

ALLIS



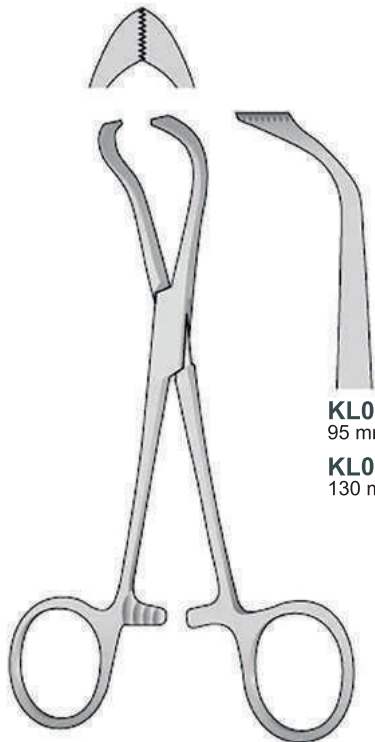
KL043
155 mm
5x6 Diş
5x6 Teeth

BOYS-ALLIS



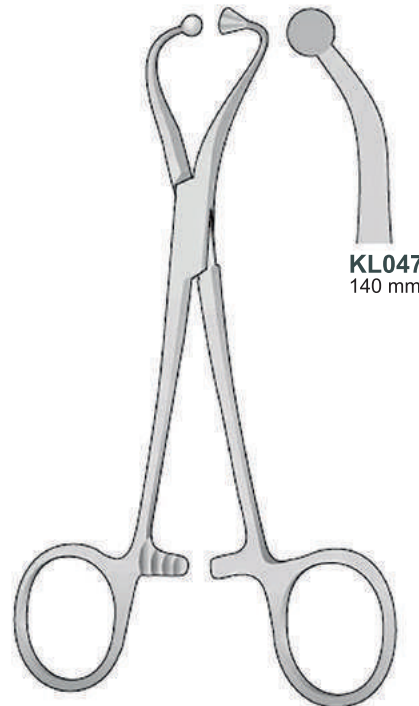
KL044
155 mm
3x4 Diş
3x4 Teeth

JUDD-ALLIS



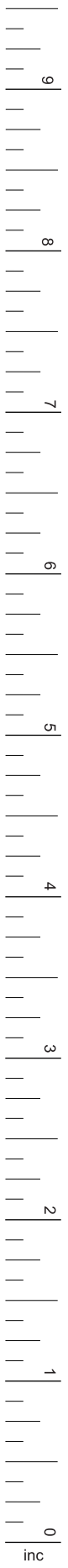
KL045
95 mm
KL046
130 mm

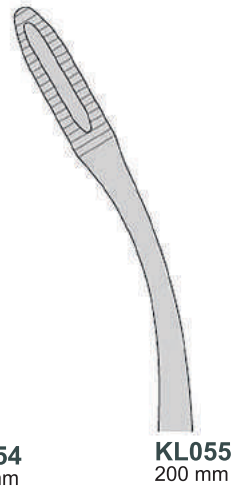
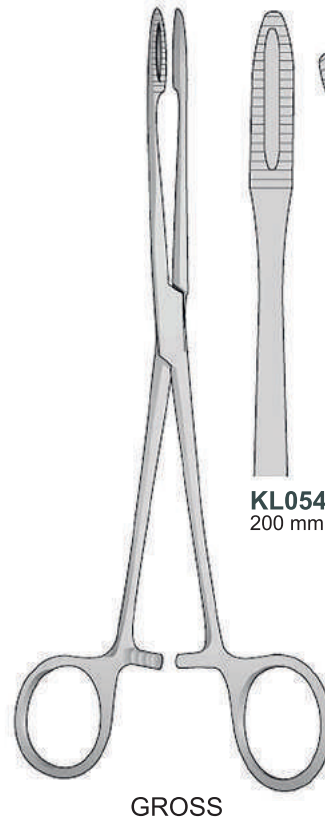
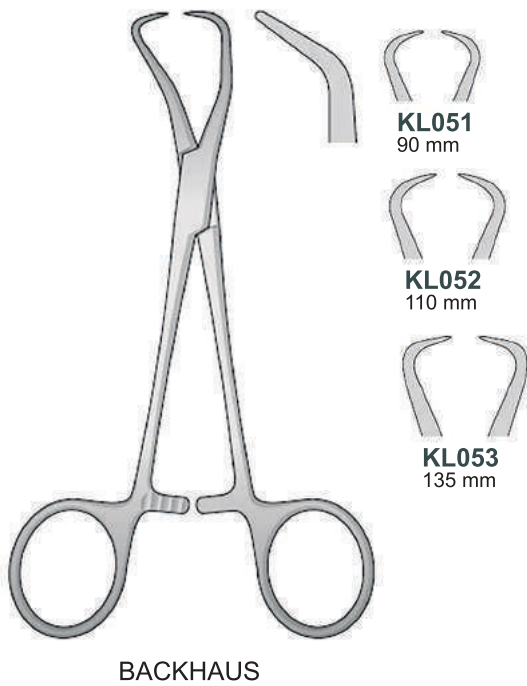
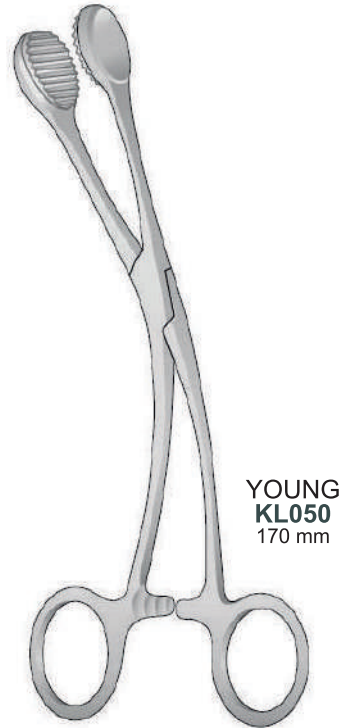
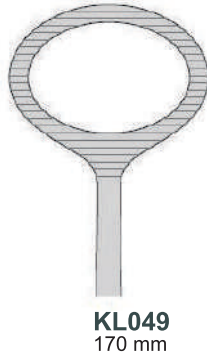
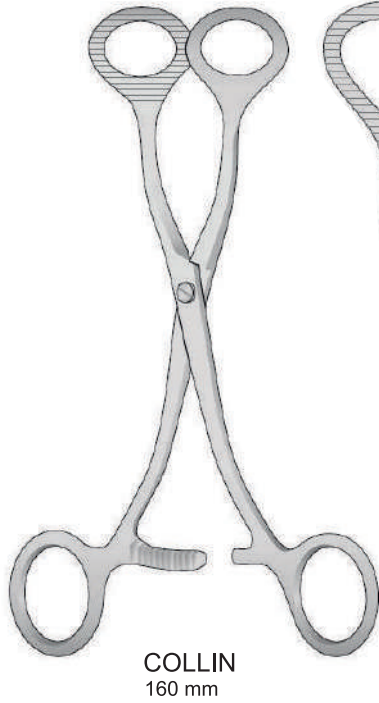
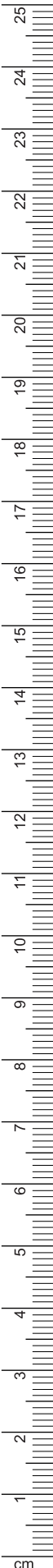
LORNA



KL047
140 mm

BACKHAUS

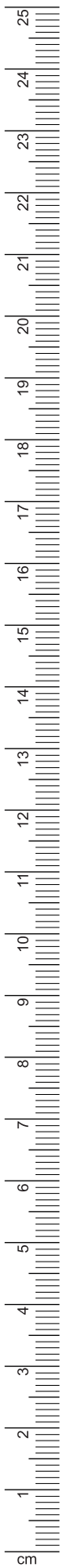




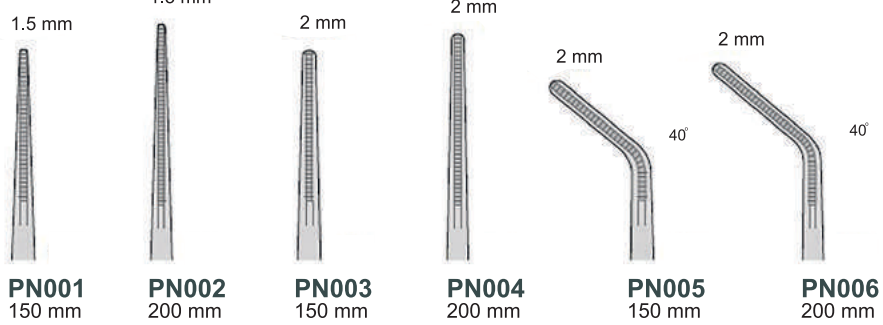


PENSETLER
TWEEZERS





DE BAKKEY



PN001
150 mm

PN002
200 mm

PN003
150 mm

PN004
200 mm

PN005
150 mm

PN006
200 mm



MICRO ADSON

PN007
120 mm



MICRO ADSON

PN008
120 mm
1x2 Diş
1x2 Teeth



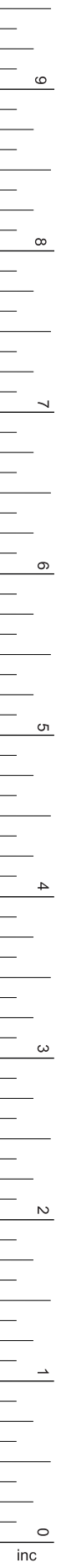
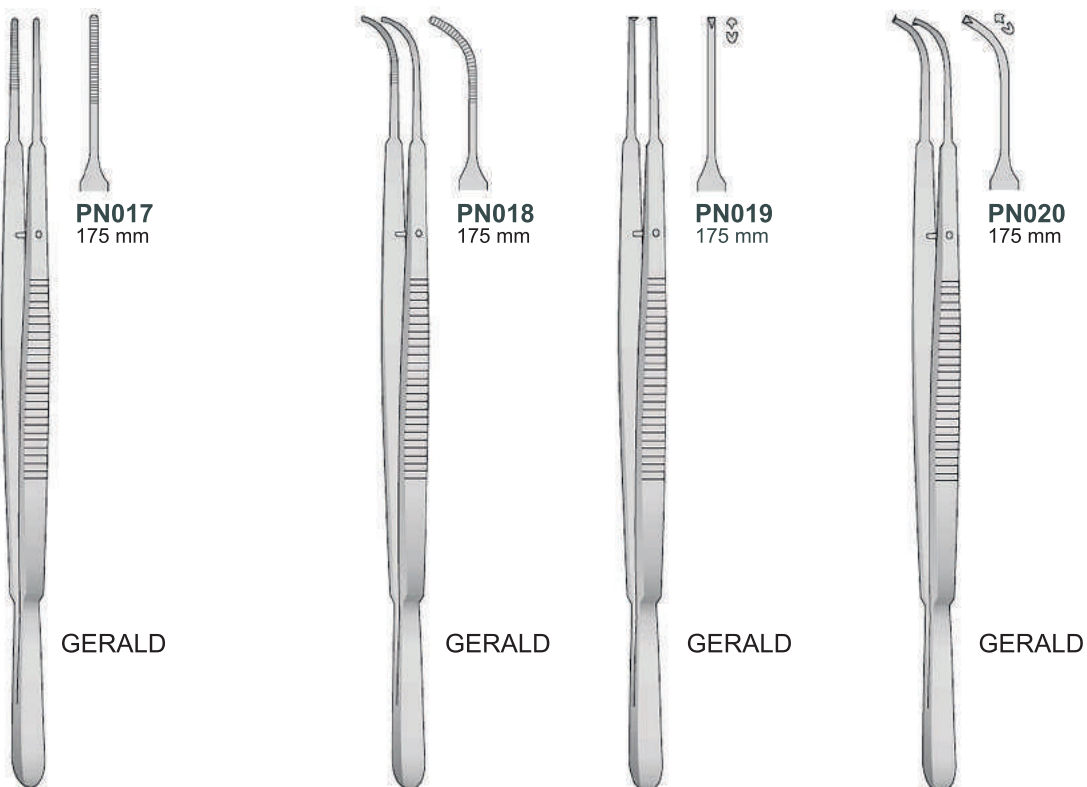
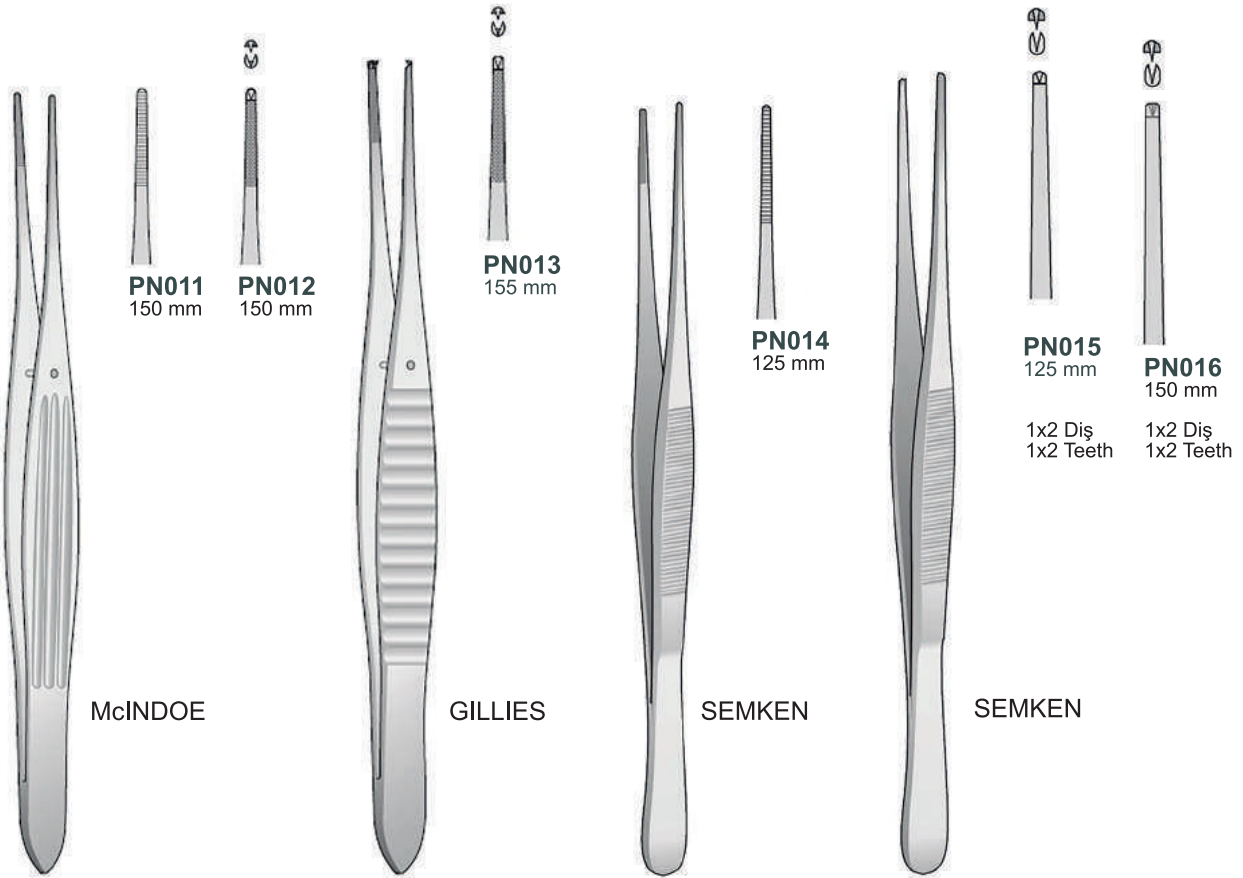
MICRO ADSON

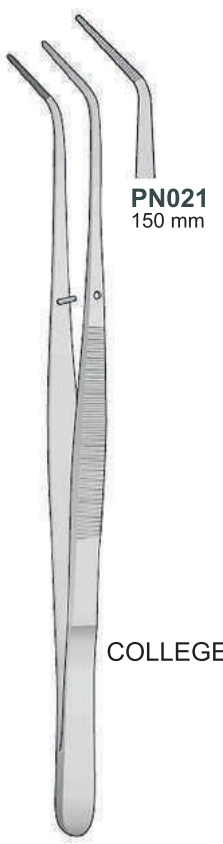
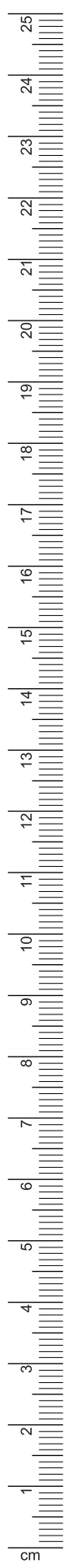
PN009
150 mm



MICRO ADSON

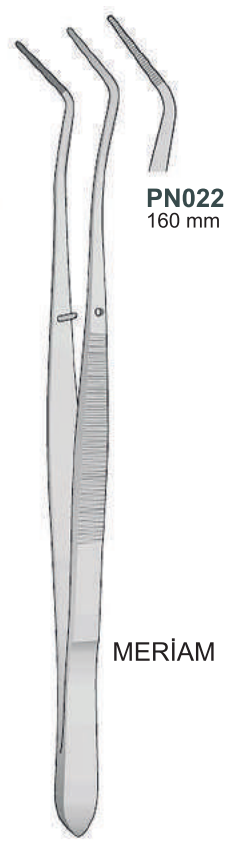
PN010
150 mm
1x2 Diş
1x2 Teeth





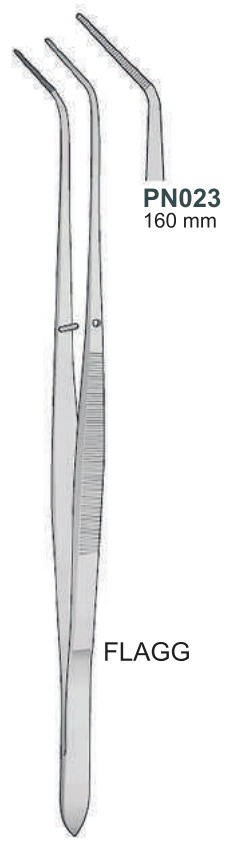
PN021
150 mm

COLLEGE



PN022
160 mm

MERIAM



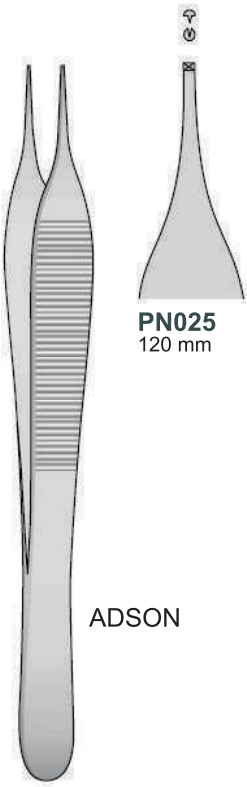
PN023
160 mm

FLAGG



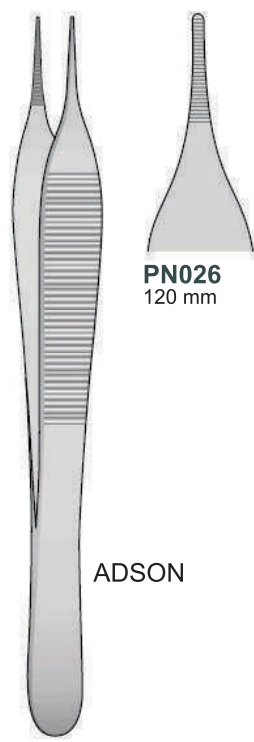
PN024
150 mm

COLLEGE-S



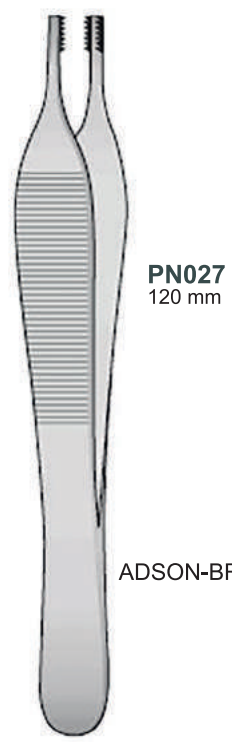
PN025
120 mm

ADSON



PN026
120 mm

ADSON



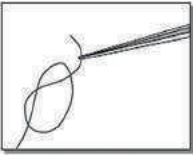
PN027
120 mm

ADSON-BROWN



PN028
150 mm

BROWN



Mikro Sütür Bağlama Pensetleri
Micro Suture Binding Tweezers



PN029
120 mm



PN030
120 mm



PN031
150 mm



PN032
150 mm



PN033
180 mm



PN034
180 mm



PN035
90 mm



PN037
105 mm



PN039
115 mm



PN041
130 mm



PN043
145 mm



PN036
90 mm



PN038
105 mm



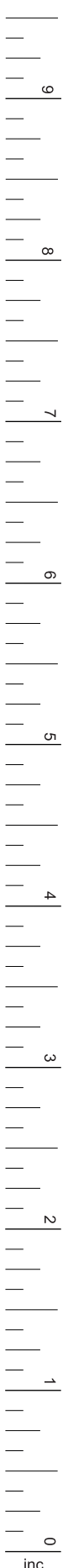
PN040
115 mm

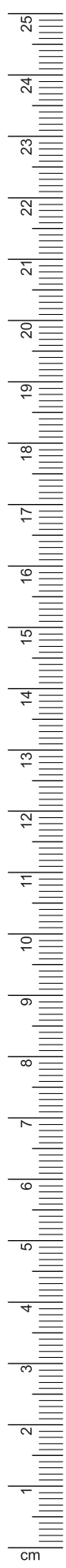


PN042
130 mm



PN044
145 mm





MILLER

PN045
145 mm



MILLER

PN046
150 mm



PN047
100 mm



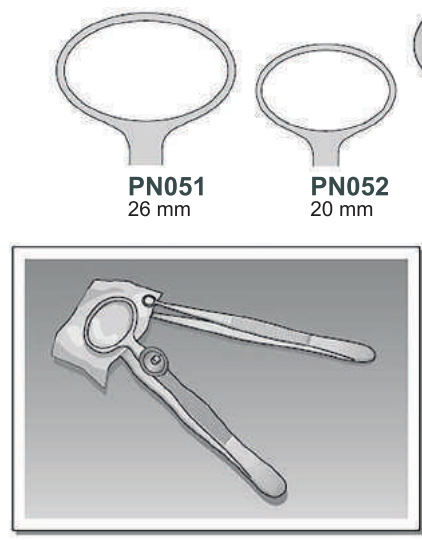
PN048
100 mm



PN049
100 mm

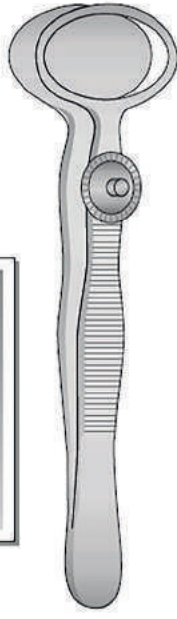


PN050
100 mm



PN051
26 mm

PN052
20 mm



DESMARRES



TASO

PN053
150 mm



KÜHNE



PN054
105 mm



BARRAQUER

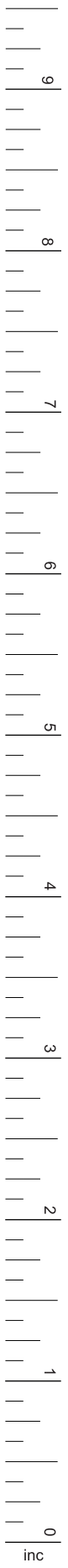


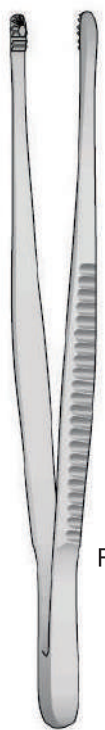
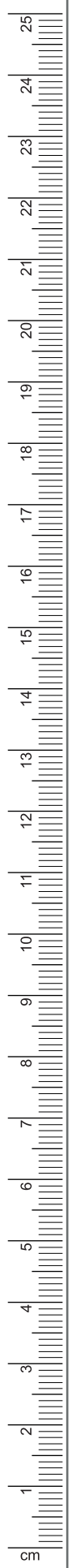
PN055
105 mm

Dişsiz



Dişli





RUSSIAN



PN072
150 mm



PN073
150 mm



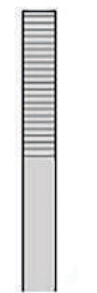
STILLE



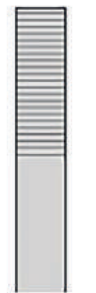
PN074
130 mm



PN075
150 mm



PN076
170 mm



PN077
200 mm



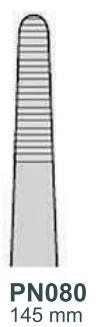
STANDART



PN078
115 mm



PN079
130 mm



PN080
145 mm



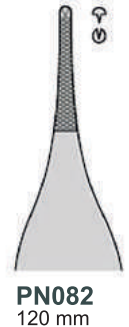
ADSON TC



PN081
120 mm



ADSON TC



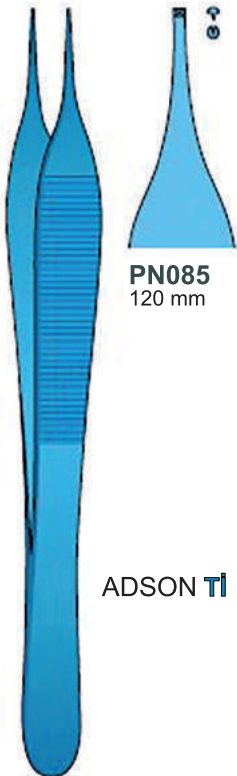
PN082
120 mm



PN083
90 mm

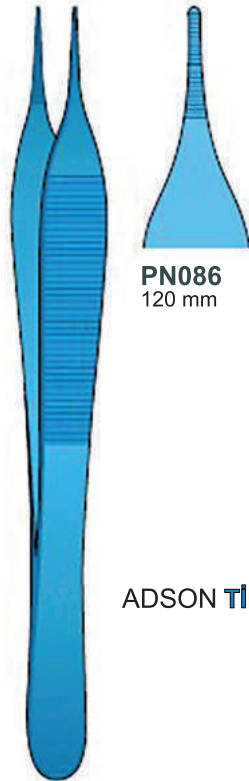


PN084
130 mm



PN085
120 mm

ADSON **Ti**



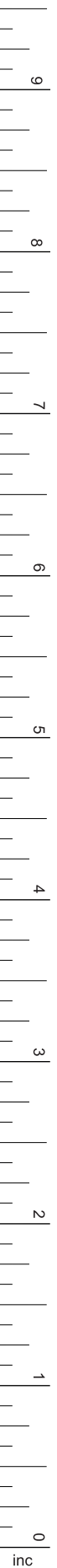
PN086
120 mm

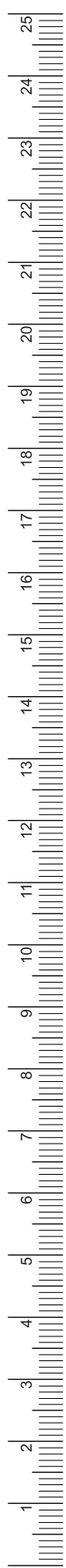
ADSON **Ti**



PN087
180 mm

PN088
200 mm





GERALD **TI**

PN089
180 mm



PN090
180 mm



DE BAKKEY **TI**

1,5 mm



PN091
160 mm

2 mm



PN092
160 mm



COLLEGE **TI**

PN093
150 mm



PN094
160 mm

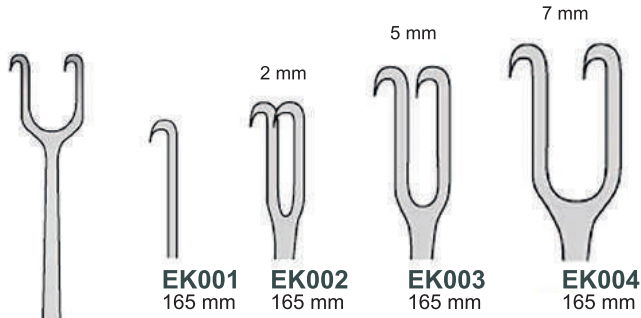
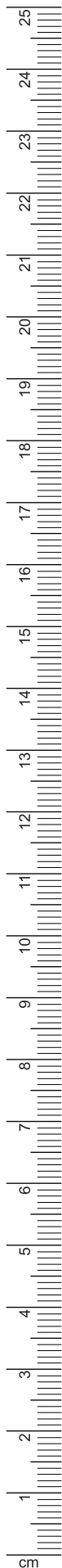
PN095
110 mm





EKARTÖRLER
RETRACTORS





JOSEPH



GILLIES

GILLIES



MINI - LANGENBECK
160 mm



DESMARRES
140 mm



EK011
9x9 mm



EK012
9x12 mm



EK013
11x14 mm



EK014
12x16 mm



EK015
13x18 mm



KOCHER
205 mm



EK016
20x12 mm



EK017
20x15 mm



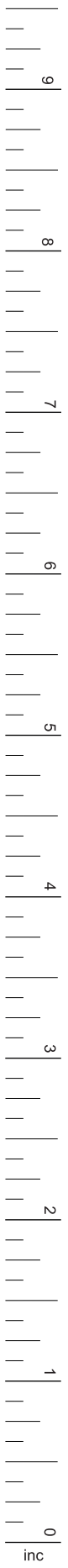
EK018
155 mm

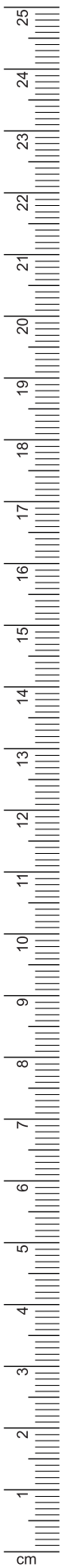
EK019
155 mm

Sivri
Sharp

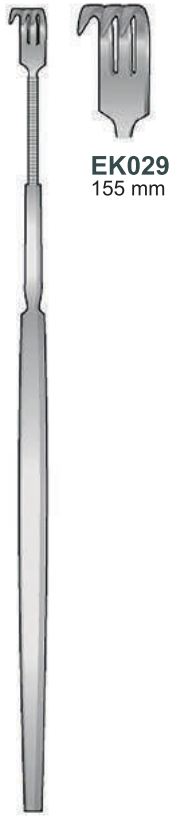
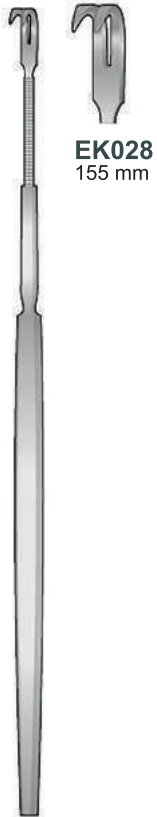
Künt
Blunt

SEAN-MILLER
155 mm



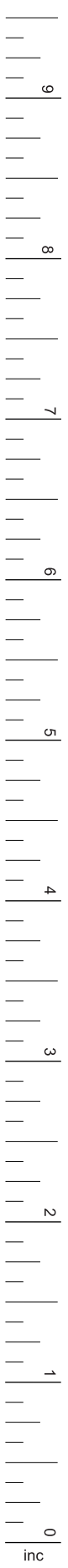
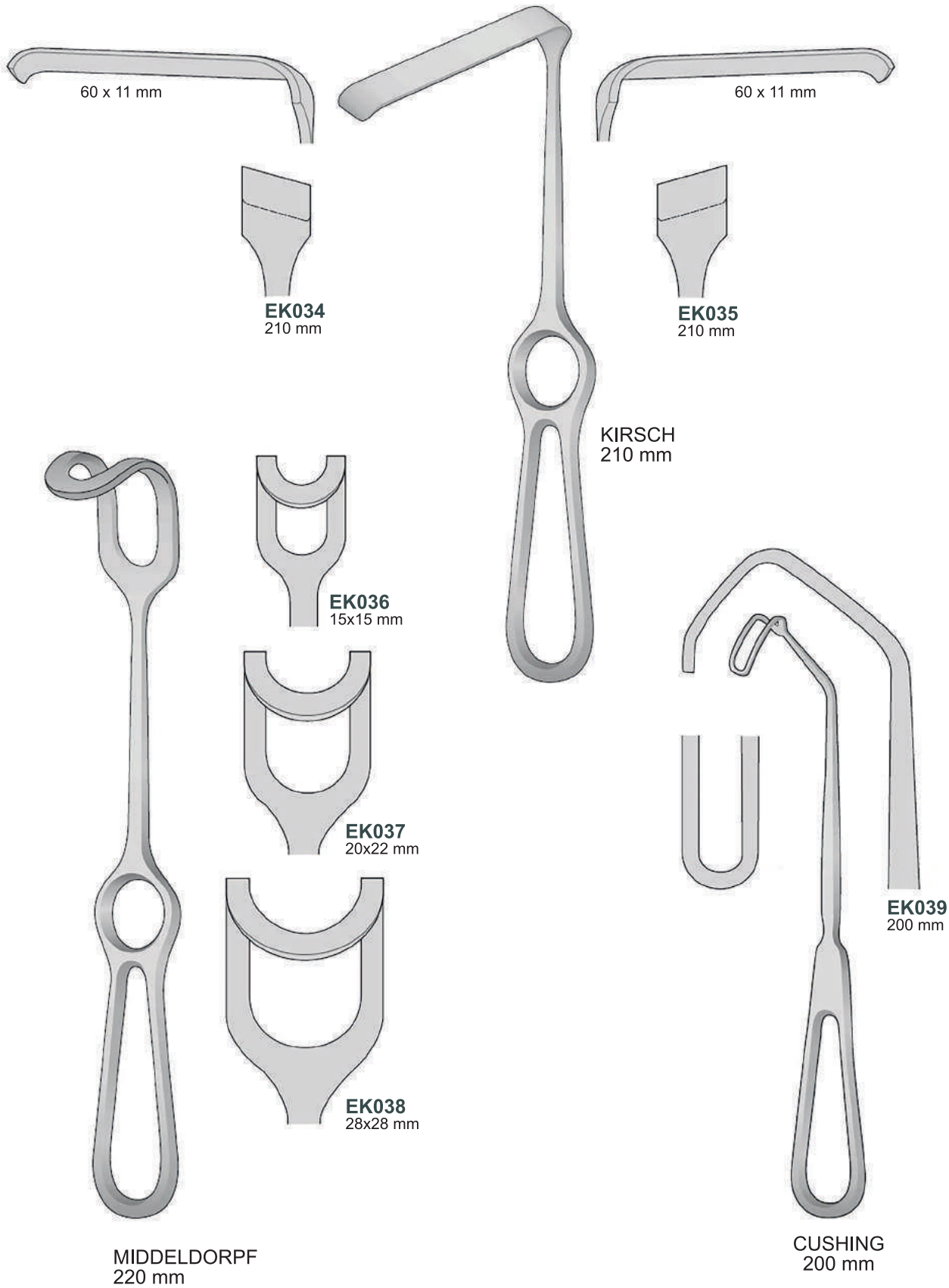


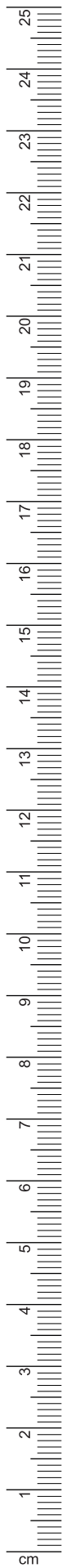
**Bükülebilir Sivri
Flexible-Sharp**



**Bükülebilir Künt
Flexible-Blunt**

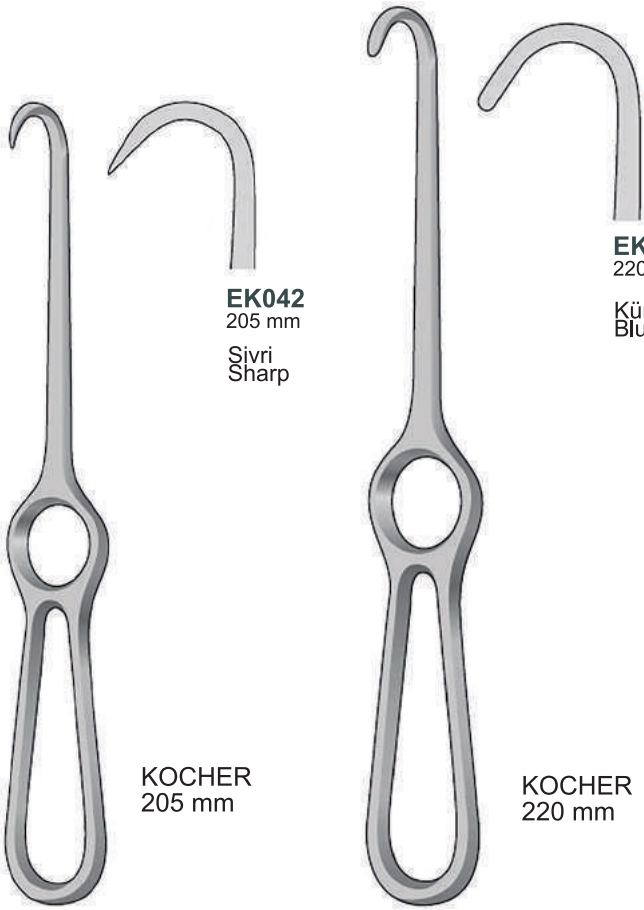






EK040
40x12 mm

EK041
55x19 mm



EK042
205 mm
Sivri
Sharp

EK043
220 mm
Kunt
Blunt

KOCHER
205 mm

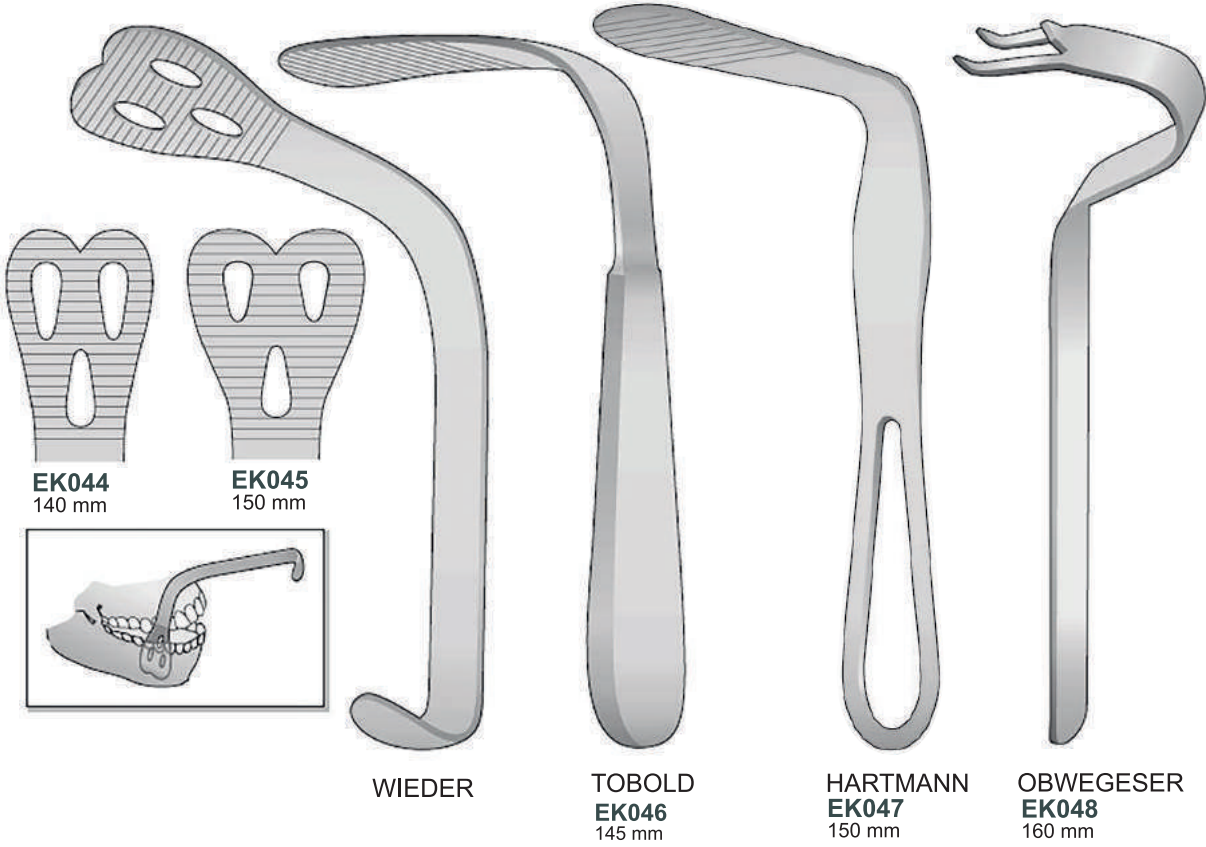
KOCHER
220 mm



DOCKHORN
210 mm

Dil Basacağı
Tongue Depressors

Çene Tutucu
Chin Holder



EK044
140 mm

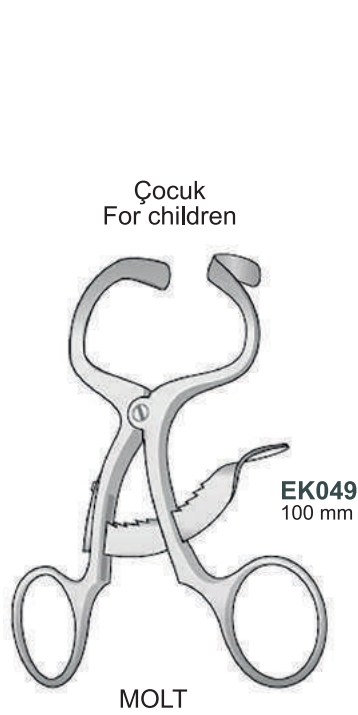
EK045
150 mm

WIEDER

TOBOLD
EK046
145 mm

HARTMANN
EK047
150 mm

OBWEGESER
EK048
160 mm



Çocuk
For children

EK049
100 mm

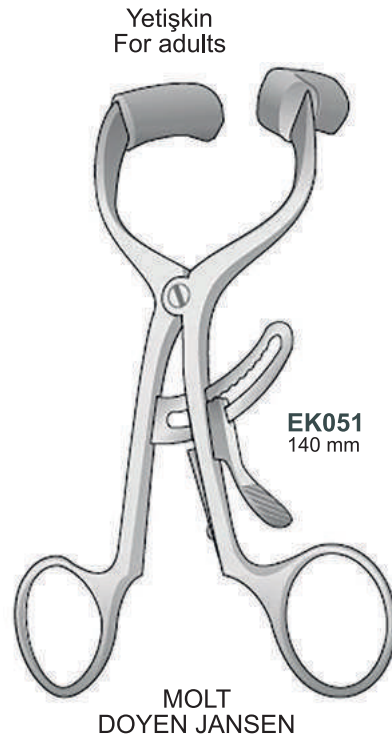
MOLT



Yetişkin
For adults

EK050
120 mm

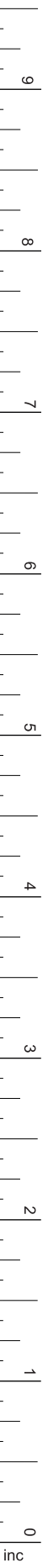
MOLT
DOYEN COLLIN

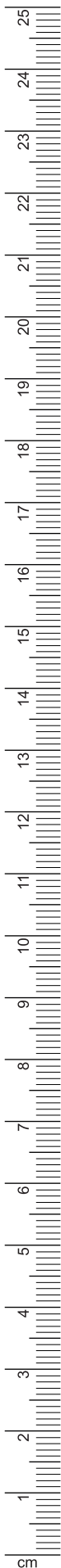


Yetişkin
For adults

EK051
140 mm

MOLT
DOYEN JANSEN

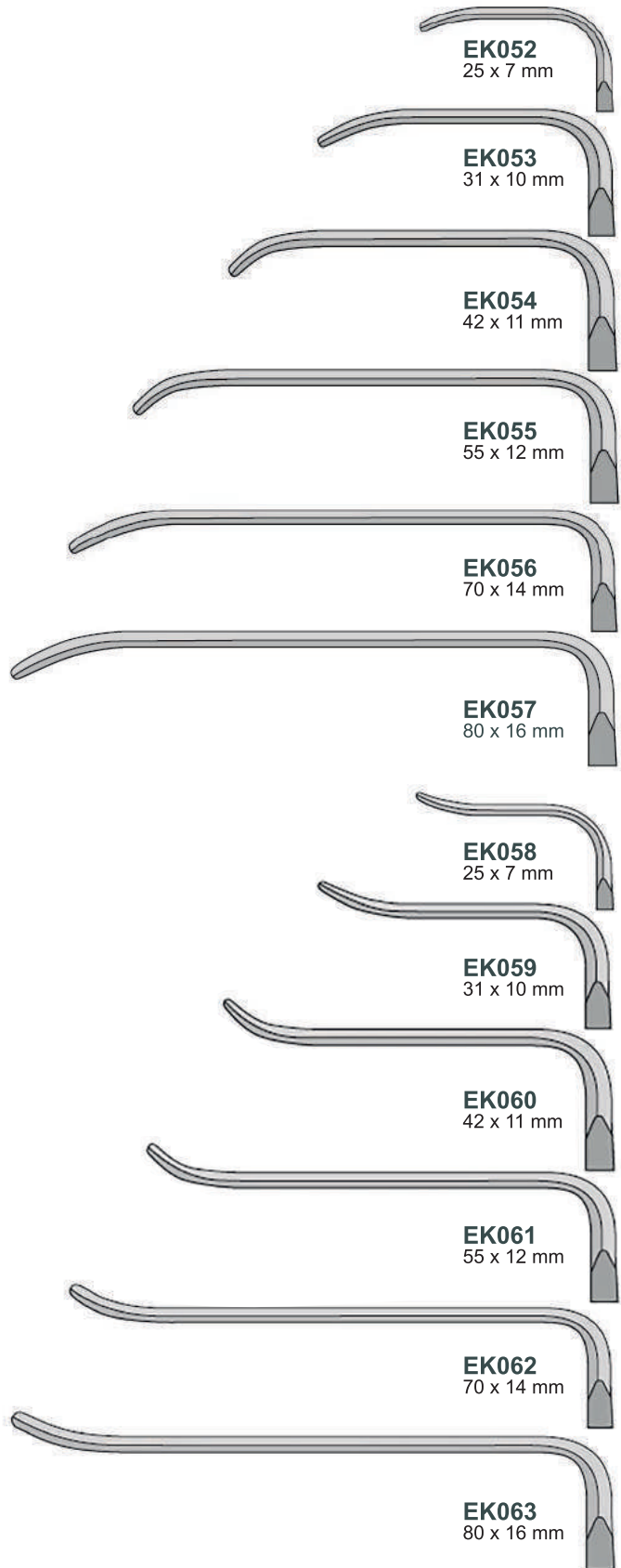




OBWEGESER
215 mm



OBWEGESER
215 mm



EK052
25 x 7 mm

EK053
31 x 10 mm

EK054
42 x 11 mm

EK055
55 x 12 mm

EK056
70 x 14 mm

EK057
80 x 16 mm

EK058
25 x 7 mm

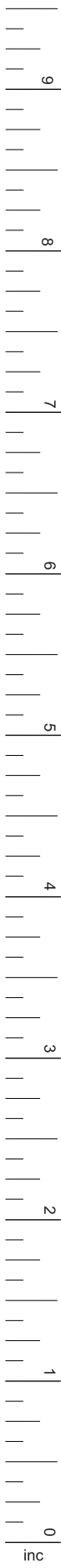
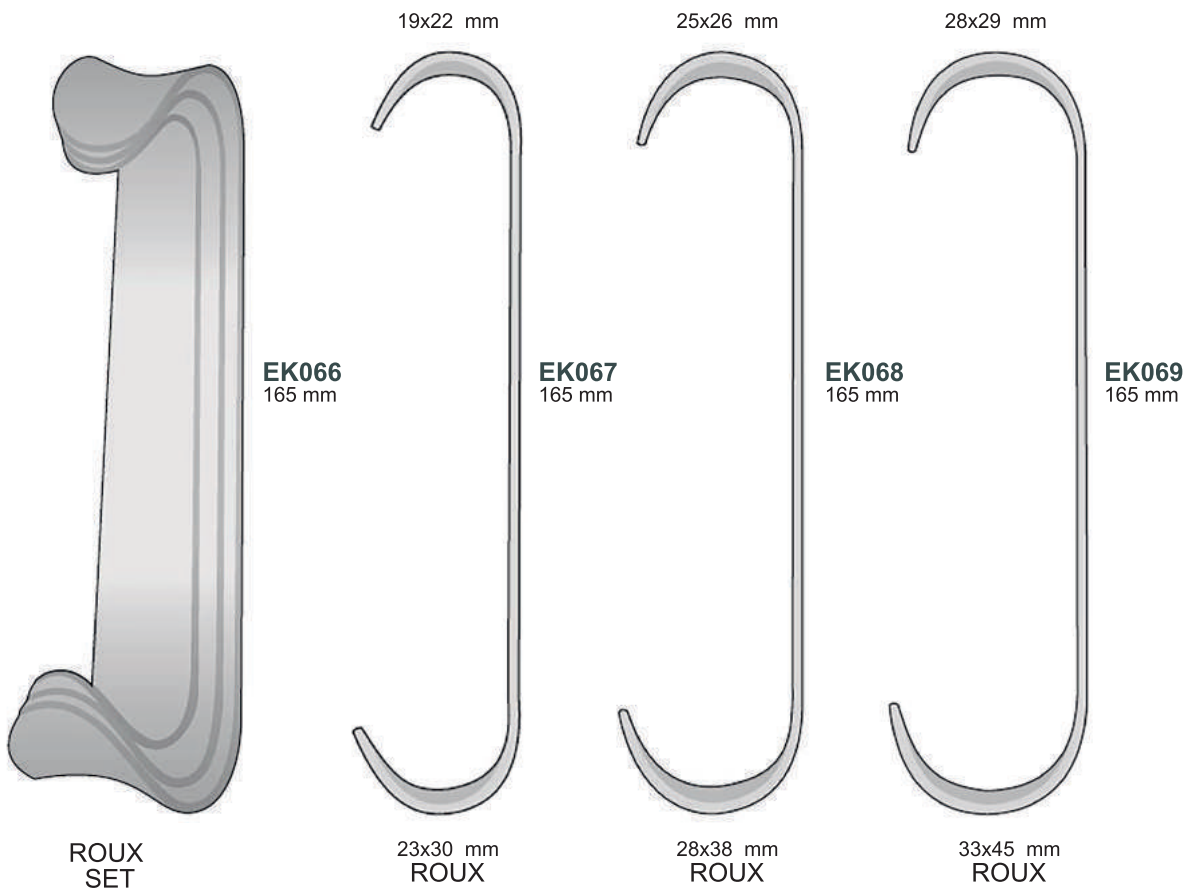
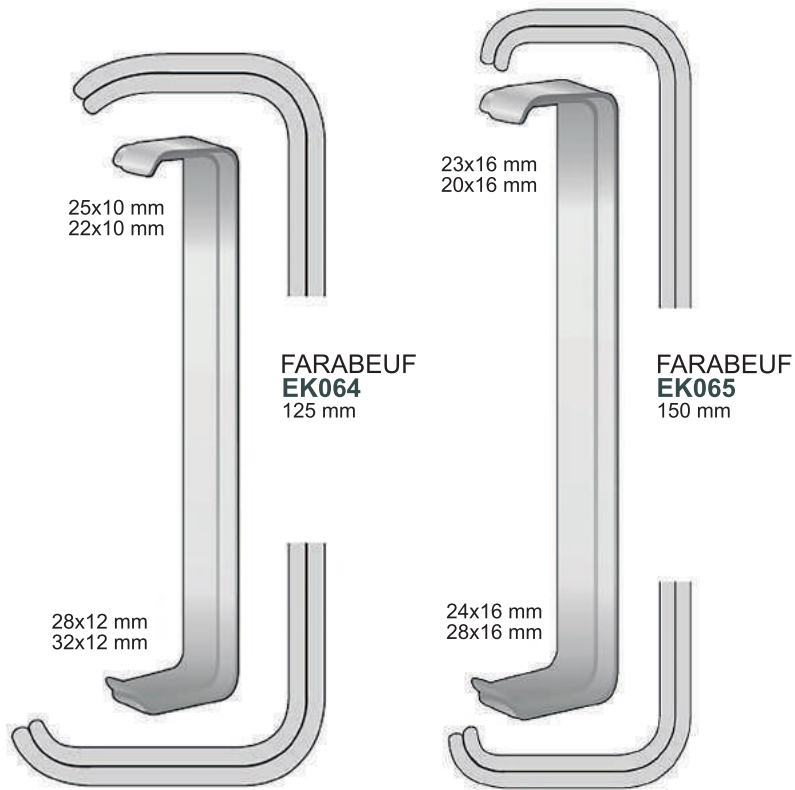
EK059
31 x 10 mm

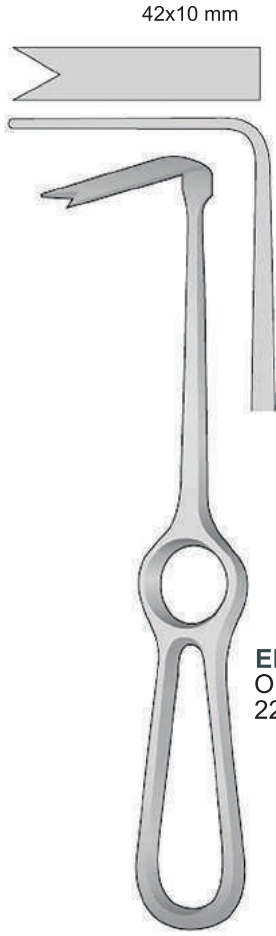
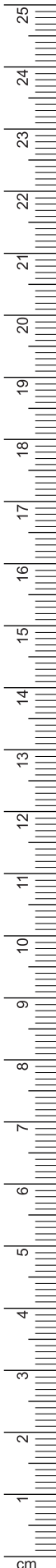
EK060
42 x 11 mm

EK061
55 x 12 mm

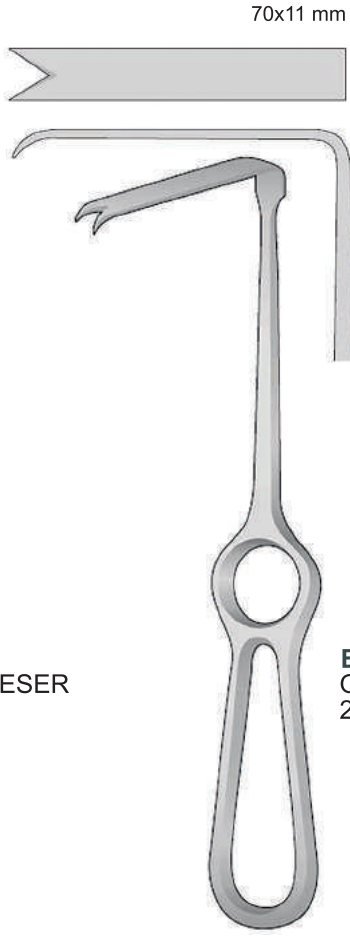
EK062
70 x 14 mm

EK063
80 x 16 mm





EK070
OBWEGESER
220 mm



EK071
OBWEGESER
220 mm



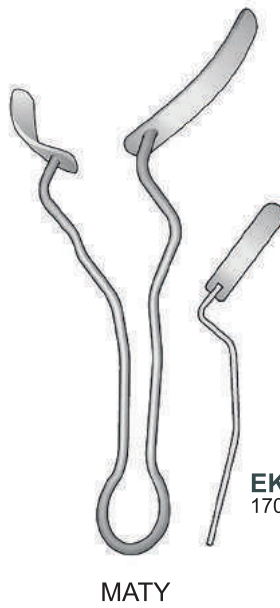
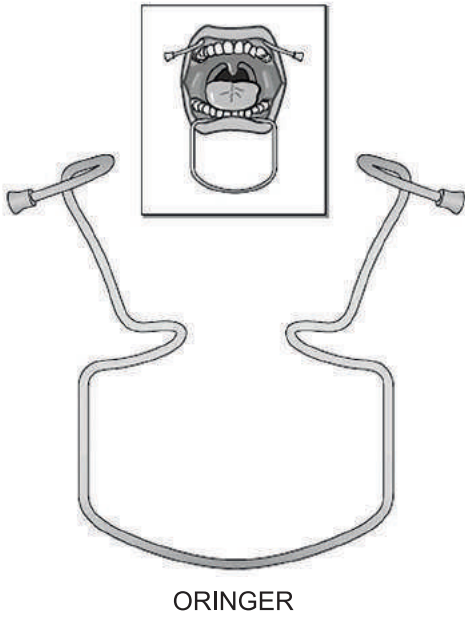
EK072
200x12 mm

EK073
200x17 mm

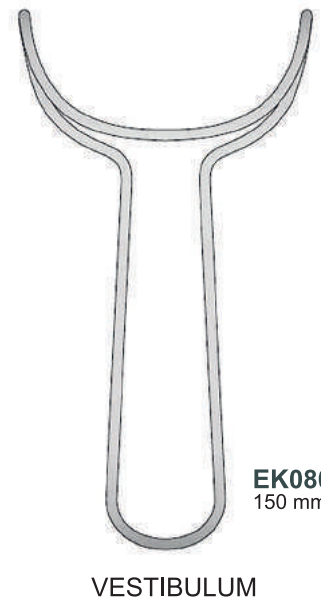
EK074
250x25 mm

BÜKÜLEBİLİR
MALLEABLE

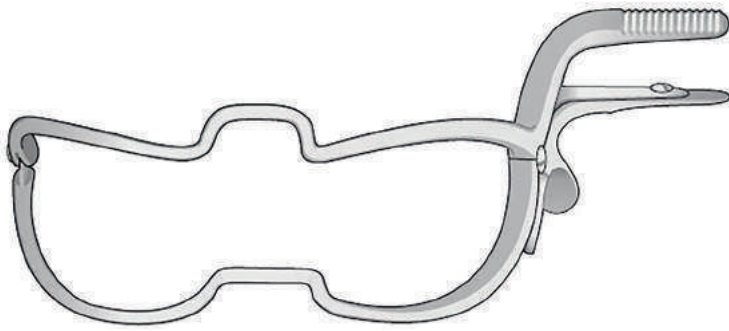
- EK075** Fig. 0 100x95 mm
- EK076** Fig. 1 115x105 mm
- EK077** Fig. 2 115x110 mm
- EK078** Fig. 3 125x115 mm



EK079
170 mm



EK080
150 mm



WHITEHEAD-JENNINGS

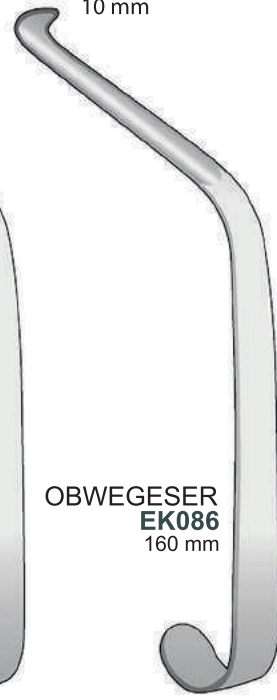
- EK081**
90 mm
- EK082**
110 mm
- EK083**
130 mm
- EK084**
150 mm

8 mm

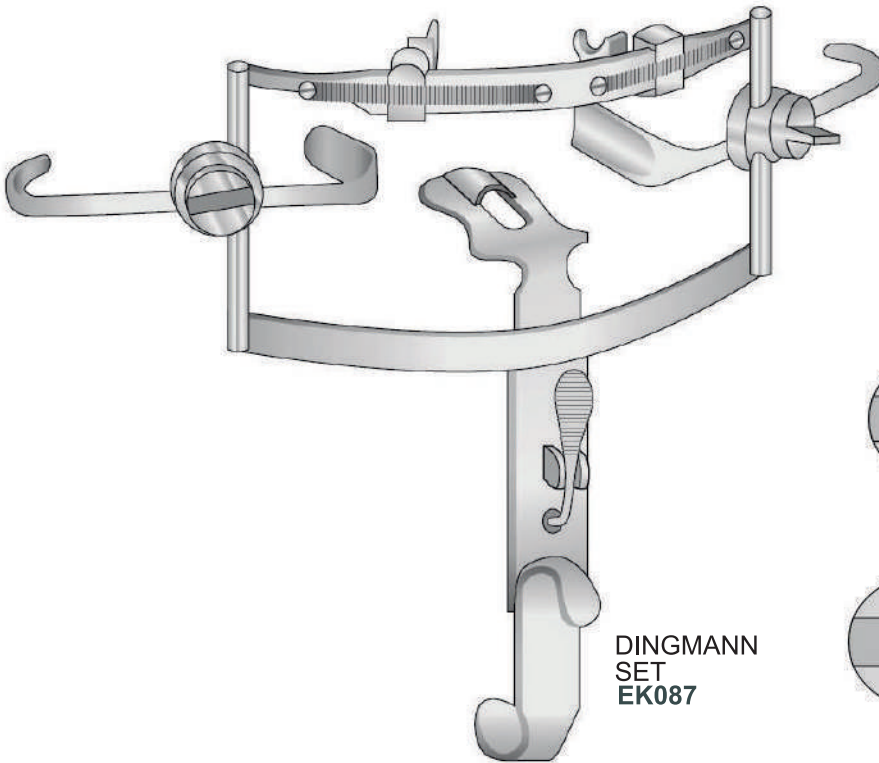


OBWEGESER
EK085
160 mm

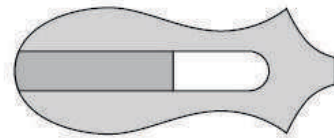
10 mm



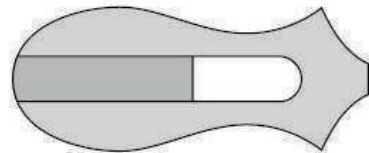
OBWEGESER
EK086
160 mm



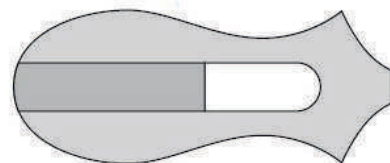
DINGMANN
SET
EK087



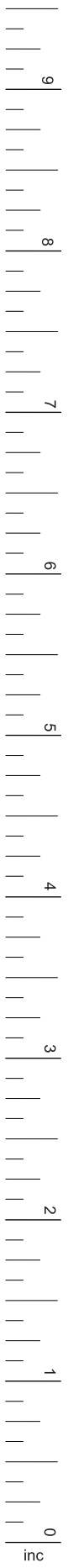
EK088
25x55 mm

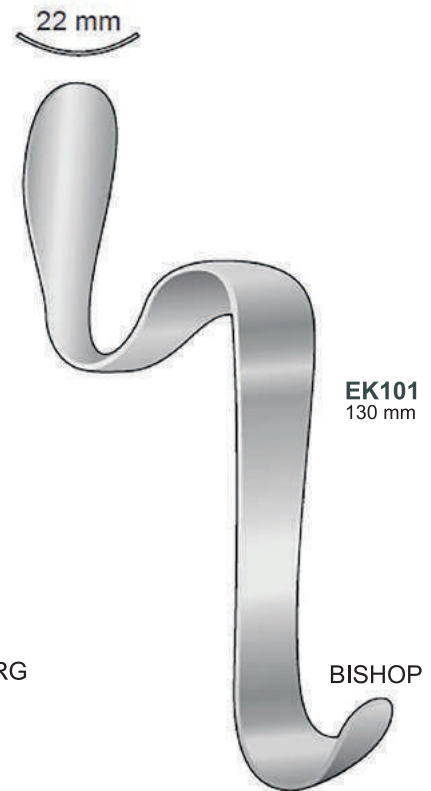
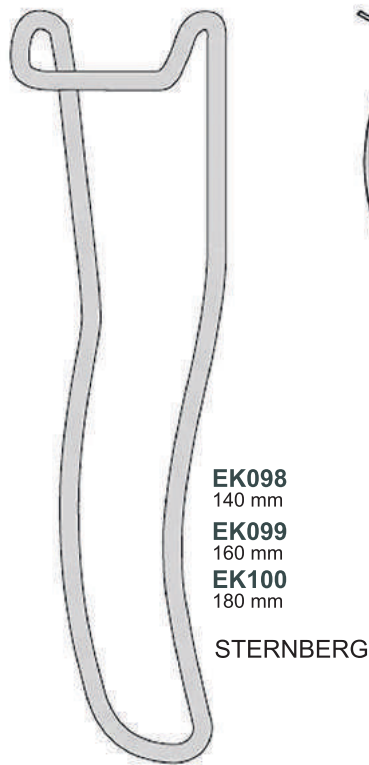
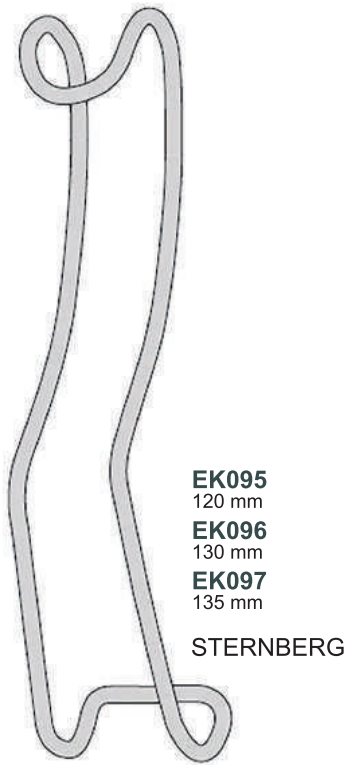
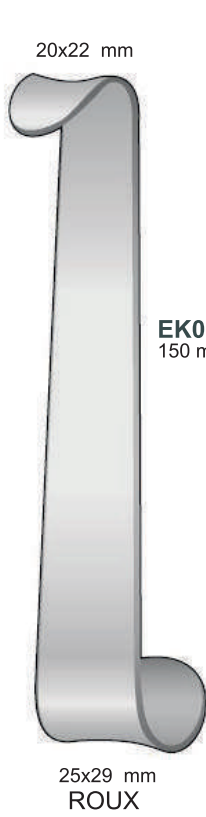
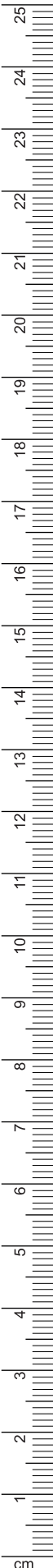


EK089
27x60 mm



EK090
30x70 mm

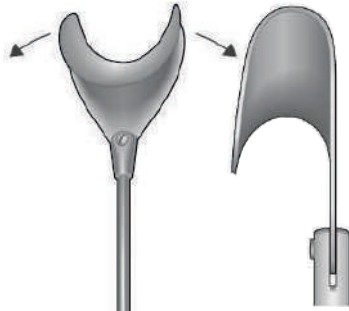




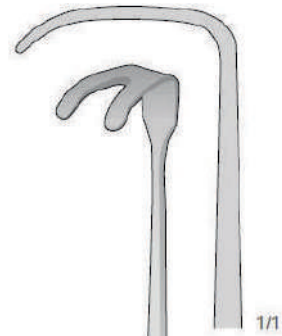


22x22 mm

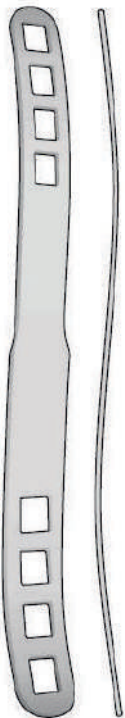
GREENE
EK102
225 mm



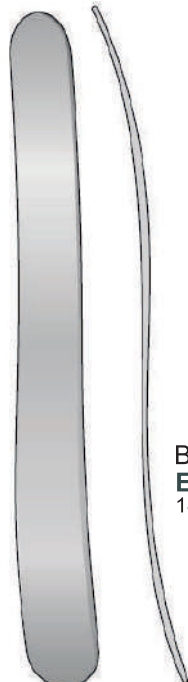
BLADE
EK103
205 mm



WASSMUND
EK104
220 mm



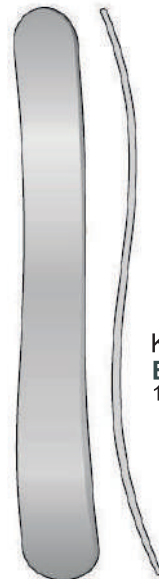
BRUENINGS
EK105
190 mm



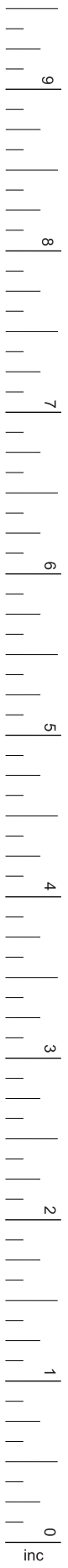
BUCHWALD
EK106
180 mm

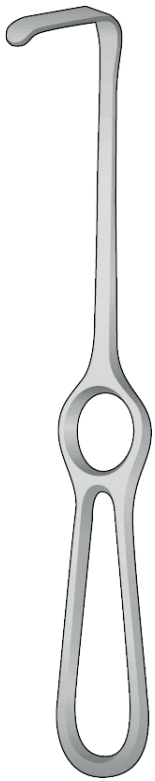
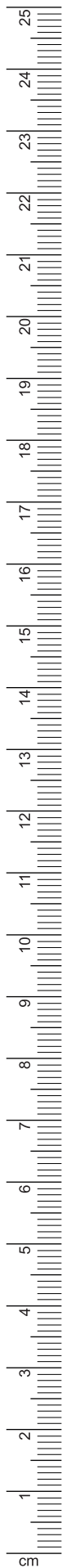


FRENZEL
EK107
165 mm

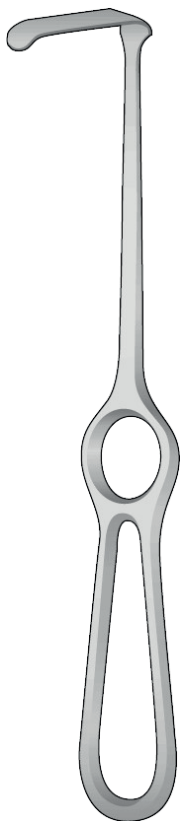


KROENIG
EK108
150 mm

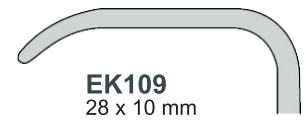




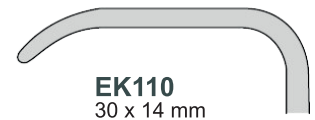
LANGENBECK
210 mm



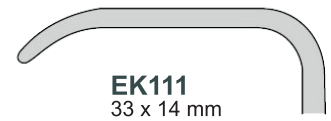
KOCHER-LANGENBECK
215 mm



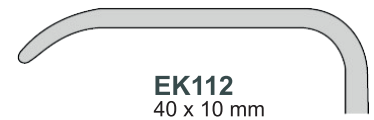
EK109
28 x 10 mm



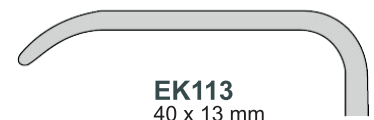
EK110
30 x 14 mm



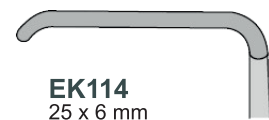
EK111
33 x 14 mm



EK112
40 x 10 mm



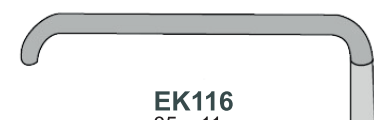
EK113
40 x 13 mm



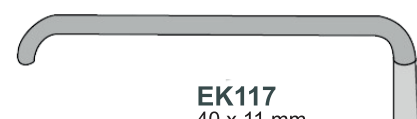
EK114
25 x 6 mm



EK115
35 x 8 mm



EK116
35 x 11 mm



EK117
40 x 11 mm



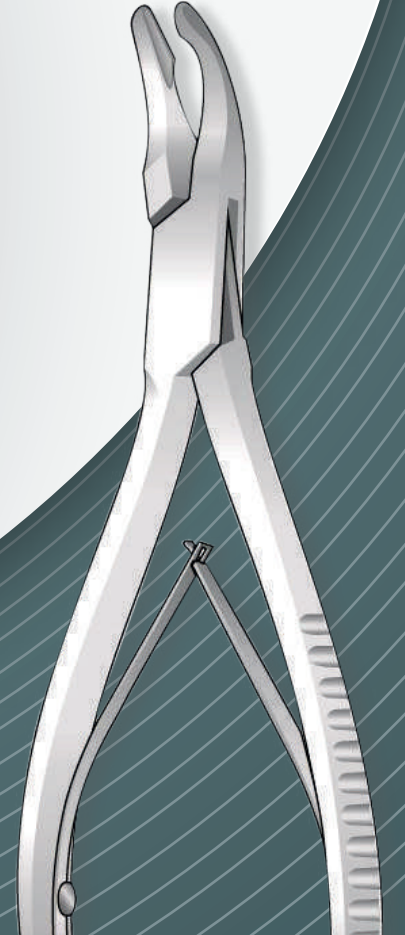
EK118
55 x 11 mm

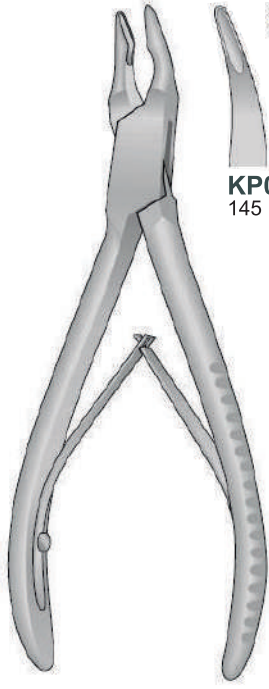
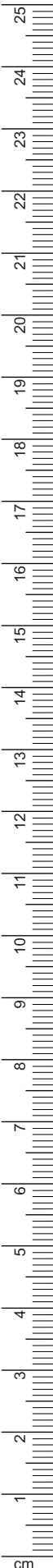


KEMİK EĞELERİ
BONE FILES

KEMİK KÜRETLERİ
BONE CURETTES

KEMİK PENSLERİ
BONE RONGEURS

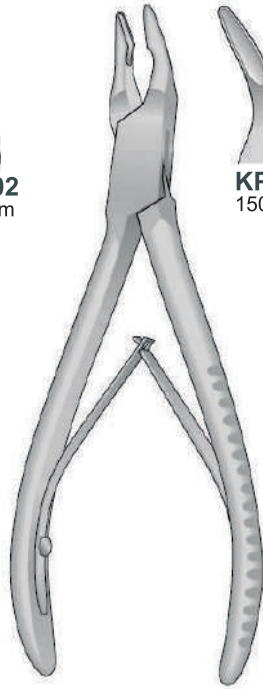




FRIEDMANN

KP001
145 mm

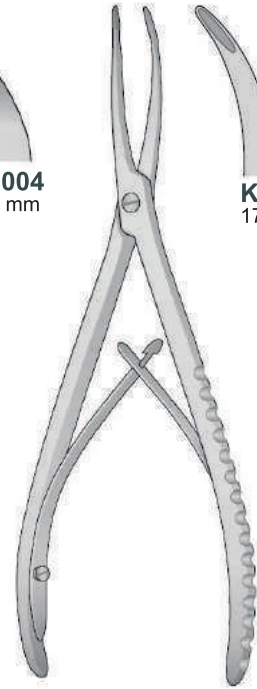
KP002
140 mm



BLUMENTHAL

KP003
150 mm

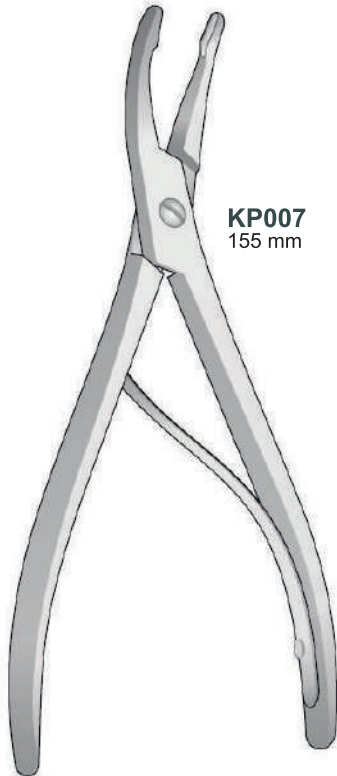
KP004
150 mm



STELLBRINK

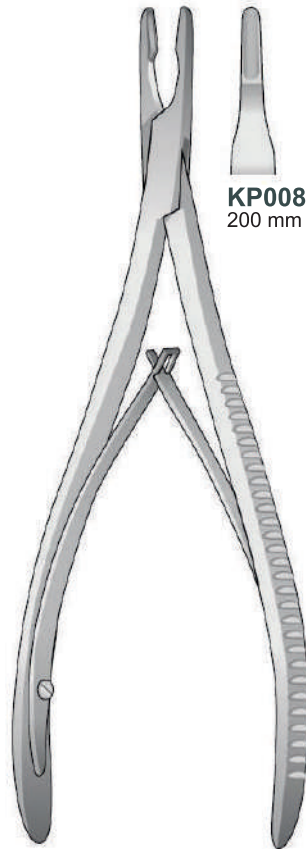
KP005
170 mm

KP006
170 mm



LUER

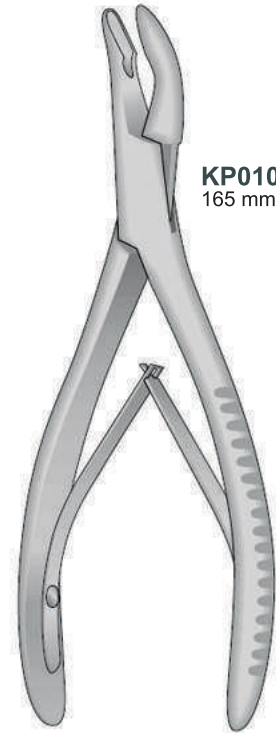
KP007
155 mm



LEMPERT

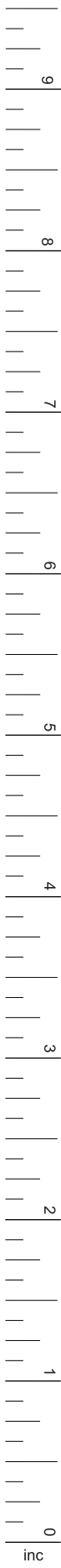
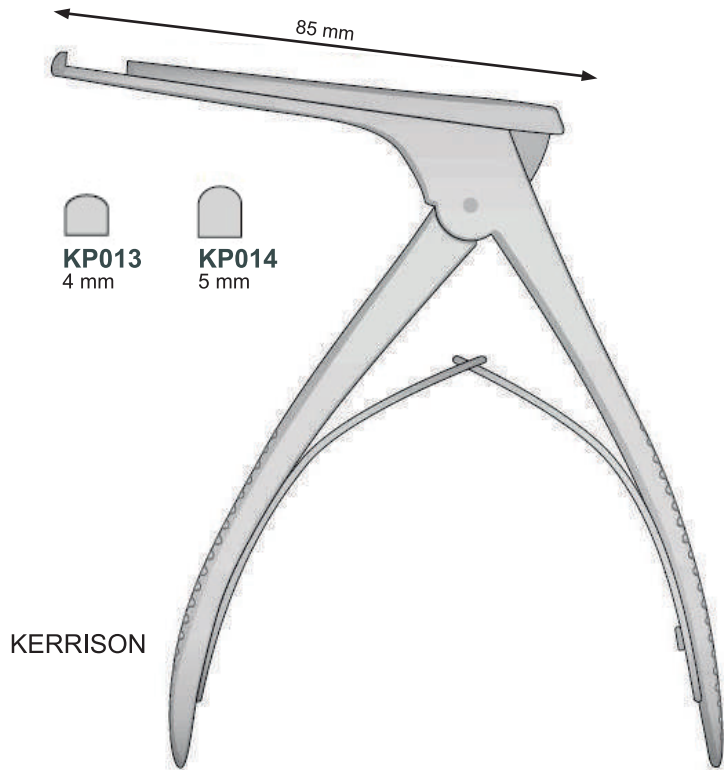
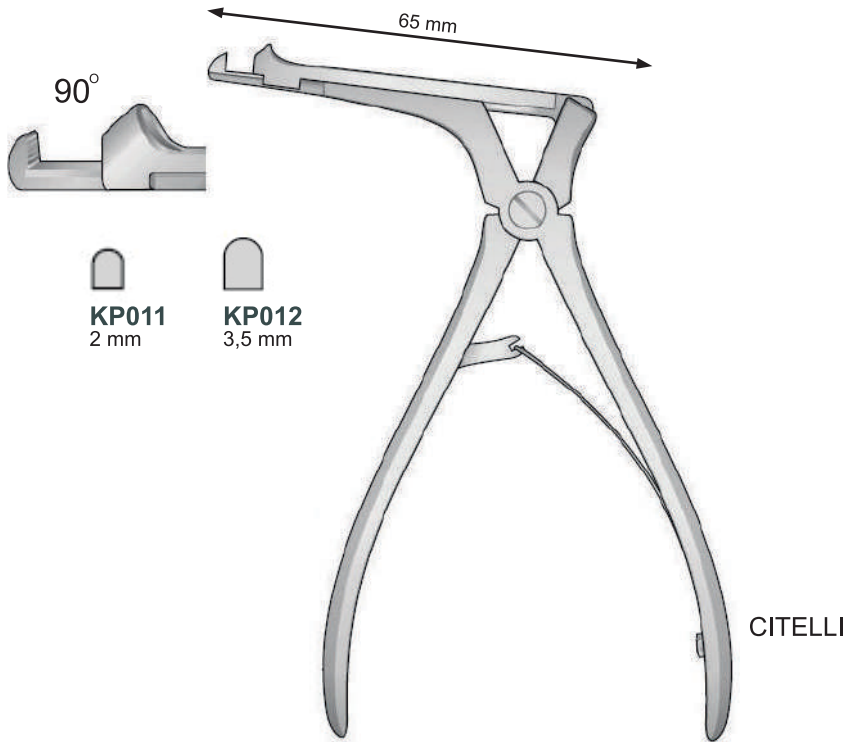
KP008
200 mm

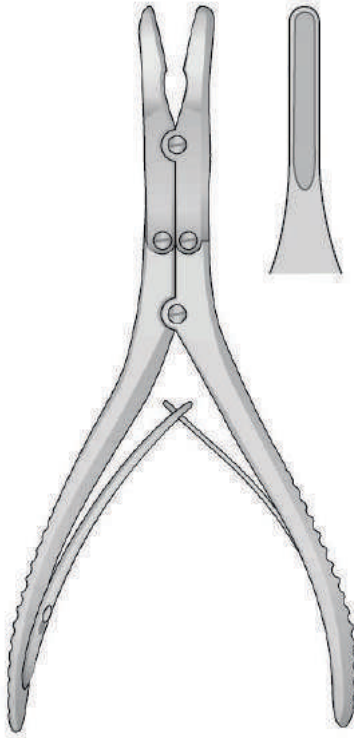
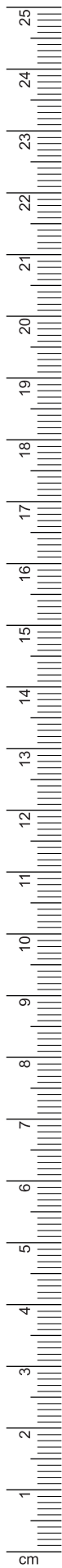
KP009
200 mm



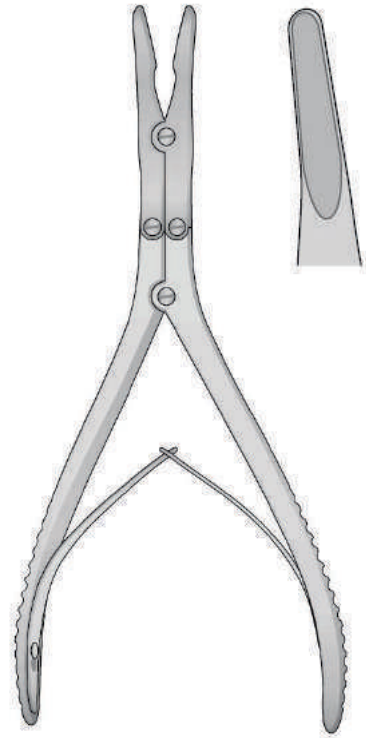
MEAD

KP010
165 mm

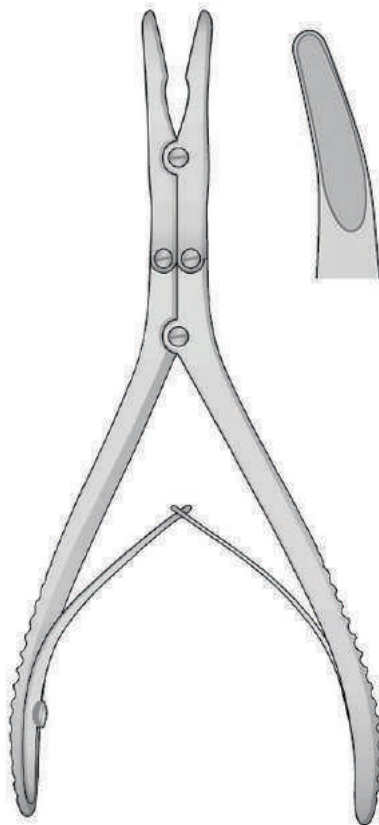




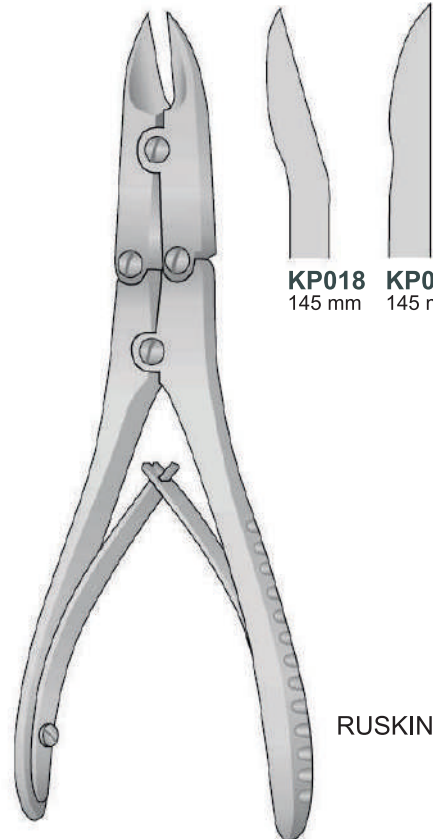
**RUSKIN
KP015**
190 mm



**BEYER
KP016**
180 mm

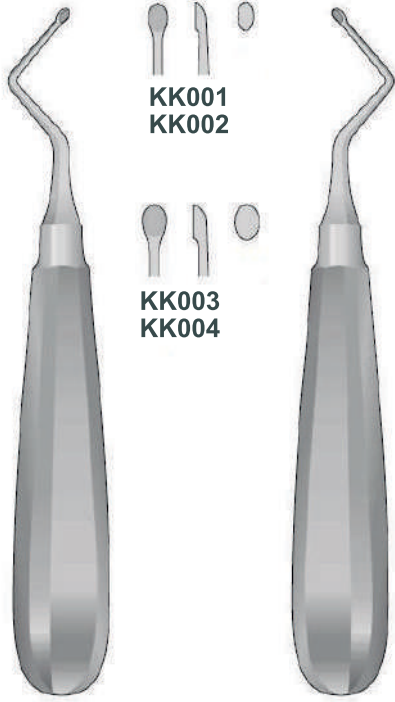


**ZAUFAL-JANSEN
KP017**
180 mm



KP018 KP019
145 mm 145 mm

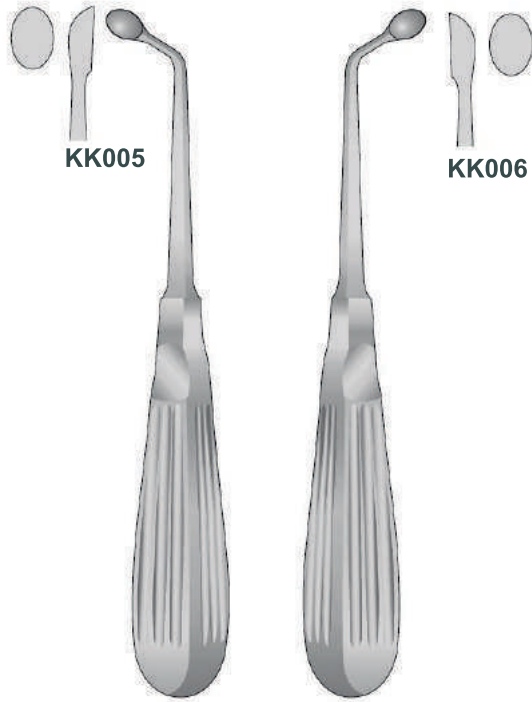
RUSKIN



KK001
KK002

KK003
KK004

KERPEL
145 mm



KK005

KK006

UFFENDORDE
170 mm



KK007
JACOBSON
140 mm



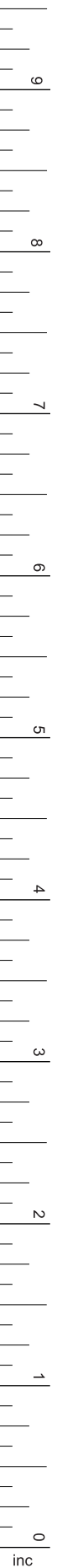
KK008
MARTINI
140 mm

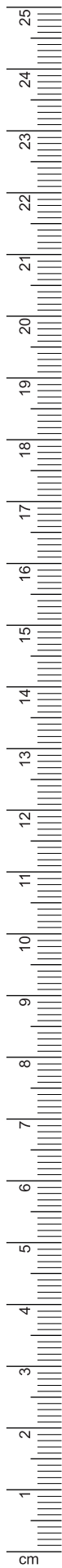


KK009
MARTINI
140 mm



KK010
WILLIGER
145 mm





HEMINGWAY



KK011
180 mm



KK012
180 mm



KK013
180 mm



KK014
180 mm



KK015
JANSEN
160 mm



KK016
BARTH
180 mm



KK017
VOLKMANN
145 mm



KK018
VOLKMANN
170 mm



LUCAS



KK019
180 mm



KK020
180 mm



KK021
180 mm



KK022
180 mm



KK023
160 mm



JANSEN
KK024
160 mm



BRUNS
165 mm



KK025
3 mm



KK026
4 mm



KK027
5 mm



KK028
6 mm



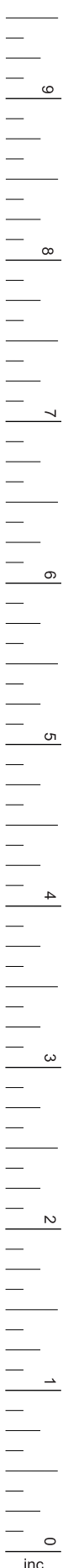
KK029
8 mm

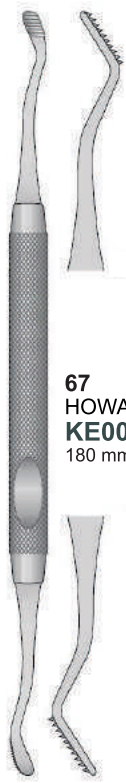
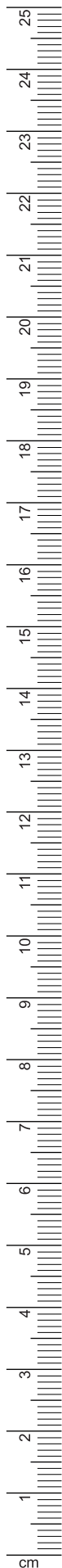


KK030
10 mm



KK031
12 mm





**67
HOWARD
KE001**
180 mm



**45
MILLER
KE002**
185 mm



**52
MILLER
KE003**
180 mm



**12
HOWARD
KE004**
170 mm



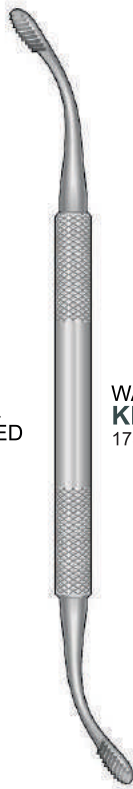
**12A
MILLER
KE005**
170 mm



**64
MILLER
KE006**
175 mm



**CORD
PACKER
ROUNDED
KE007**
175 mm



**WAHL
KE008**
175 mm



**WAHL
KE009**
175 mm



**1S/2S
SUGARMAN
KE010**
180 mm



**11/12
BUCK
KE011**



**9/10
SCHLUGER
KE012**

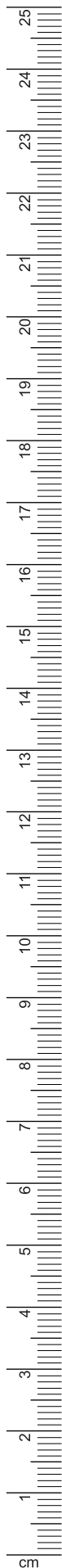


**11/12
SUGARMAN
KE013**



PERIODONTAL
PERIODONTAL





11/14
GRACEY
PR020
170 mm



12 / 13
GRACEY
PR021
170 mm



1
DE MARCO
PR022
170 mm



2
DE MARCO
PR023
170 mm



2R/2L
COLUMBIA
PR024
170 mm



4R/4L
COLUMBIA
PR025
170 mm



13/14
COLUMBIA
PR026
170 mm



1/2
LANGER
PR027
170 mm



3/4
LANGER
PR028
170 mm



11/12
McCall
PR029
170 mm



13/14
McCall
PR030
170 mm

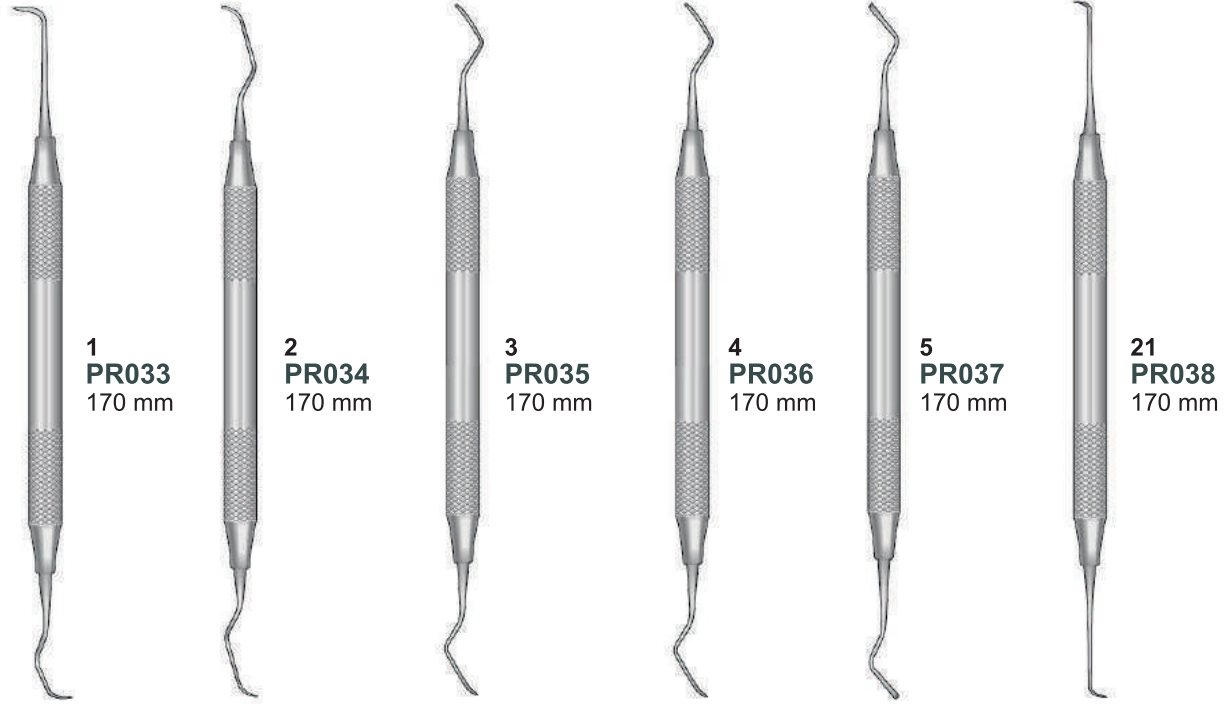


13S/14S
McCall
PR031
170 mm

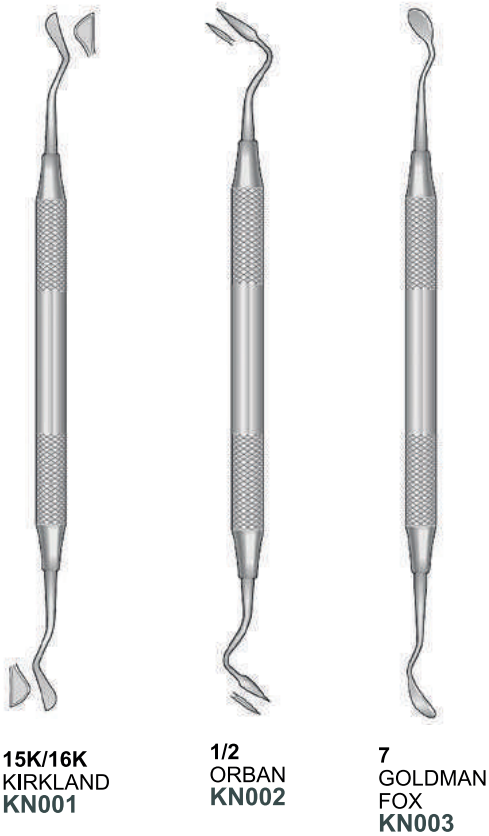


17/18
McCall
PR032
170 mm

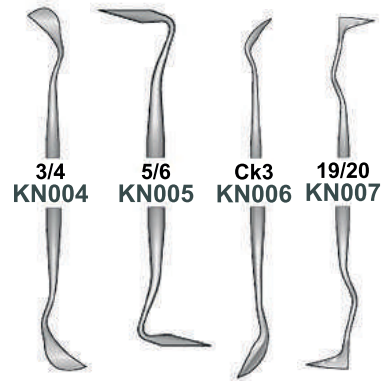
GOLDMAN-FOX



PERİODONTAL BIÇAKLAR
PERİODONTAL KNIVES

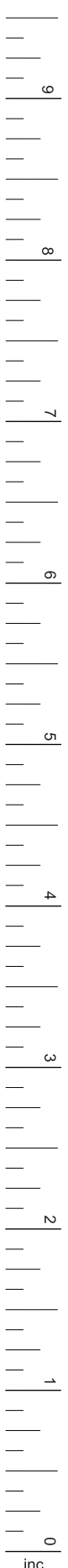
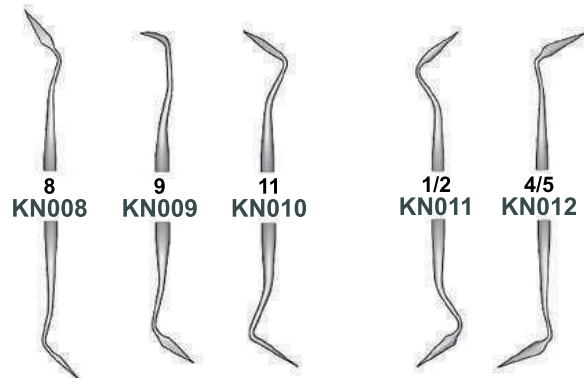


BUCK



GOLDMAN-FOX

SANDERS



STANDART GRACEY SET

- Derin Ölçekleme, kök planlaması ve periodontal müdahaleler için özel alan.
- Ofset bıçak diş yüzeyi için mükemmel bir çalışma açısı sağlar.
- Ofset bıçak açısı her bıçağın sadece alt kesme kenarı kullanılır anlamına gelir.

RİGİD GRACEY SET

- Rigid Gracey, standart Gracey'den daha kalın, daha güçlü ve daha az esnek bir şafta sahiptir.

MAKRO GRACEY SET

- Terminal şaftı Standart Gracey'den 3 mm daha uzundur.
- Standart Gracey ile karşılaştırıldığında, Bıçak % 50 daha kısa ve % 10 daha incedir.
- Derin, dar ceplerde ölçekleme için iyidir.

MİNİ GRACEY SET

- Derin periodontal ceplere erişmek için tasarlanmış daha uzun Terminal şaft.
- Standart Gracey ile karşılaştırıldığında, dar cepler ve furkasyonlarda daha iyi adaptasyon için bıçak% 50 daha kısadır.



1/2
PR039
170 mm

Ön kesici ve köpek dişleri için hafif kontra açısı



Rigid
1/2
PR040



Makro
1/2
PR041



Mini
1/2
PR042



3/4
PR043
170 mm

Ön kesici ve Kanin dişleri için kısa kontra açısı



Rigid
3/4
PR044



Makro
3/4
PR045



Mini
3/4
PR046



5/6
PR047
170 mm

Anterior ve premolar için orta kontra açısı



Rigid
5/6
PR048



Makro
5/6
PR049



Mini
5/6
PR050



7/8
PR051
170 mm

*Premolar ve molar dişler,
facial ve lingual yüzeyler için
orta kontra açısı*



Rigid
7/8
PR052



Makro
7/8
PR053



Mini
7/8
PR054



9/10
PR055
170 mm

*Molar buccal ve lingual
yüzeyler için uzun kontra
açısı ve daha belirgin bir açısı*



Rigid
9/10
PR056



Makro
9/10
PR057



Mini
9/10
PR058



11/12
PR059
170 mm

*Arka dişlerin mesial
yüzeylerine ulaşmak
için gerekli olan açısı*



Rigid
11/12
PR060



Makro
11/12
PR061



Mini
11/12
PR062



13/14
PR063
170 mm

*Arka dişlerin distal
yüzeylerine ulaşmak
için gerekli olan açısı*



Rigid
13/14
PR064



Makro
13/14
PR065



Mini
13/14
PR066

SET: PR100



ÖZEL KASETLELERLE SETİNİZİ OLUŞTURUN

- ODC kasetleri, uygulamanızın benzersiz ihtiyaçlarına uyacak şekilde değiştirilebilir.
- Kasetler işlem sırasında keskin parça yaranmalarının potansiyelini azaltmak için harika bir araçtır.
- Gracey Set sizlere 4 Farklı set halinde sunulmaktadır.
(Standart Set, Rigid Set, Makro Set, Mini Set)

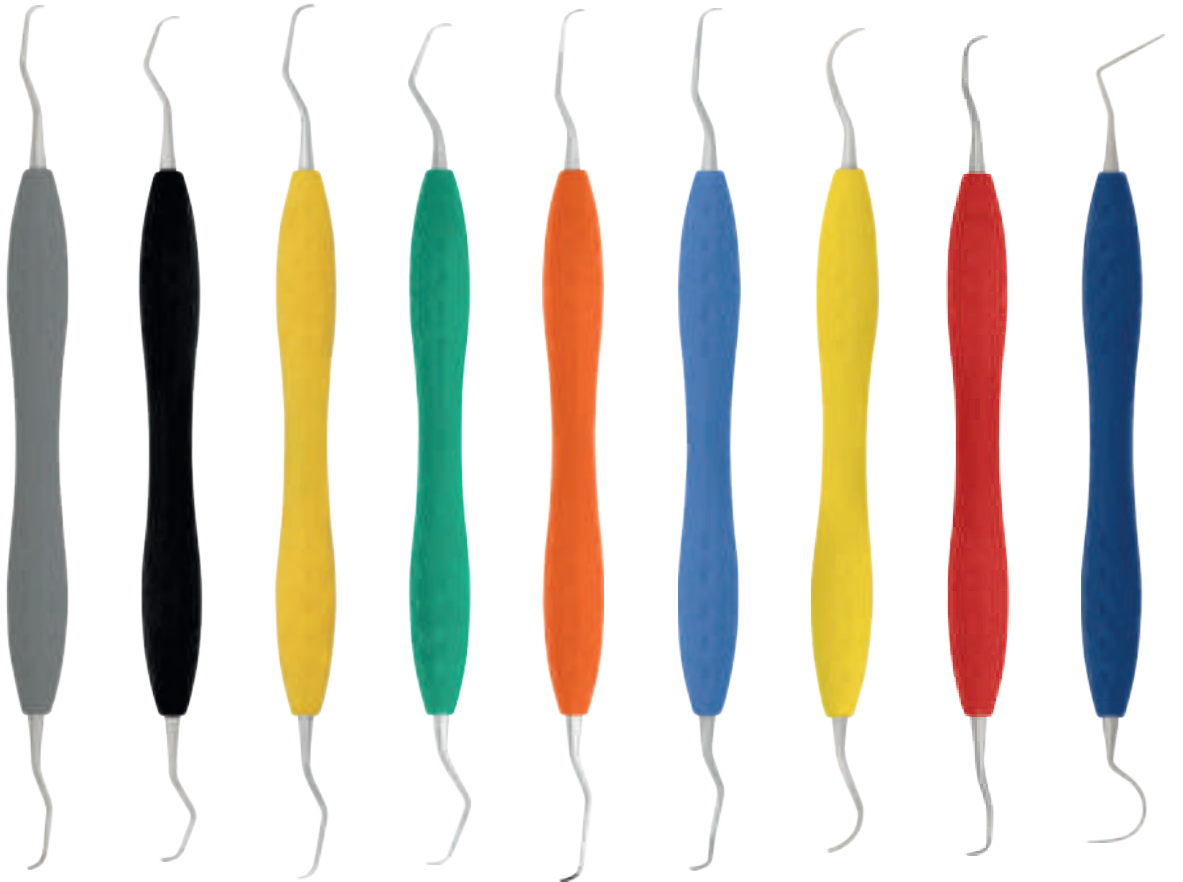
SİLİKON SAP GRACEY SET

- Güç iletimi ve hassasiyeti ile ilgili mükemmel şekil, dokunsal bir ölçüleme ve temizlik sağlar.
- Silikon teknolojisi ergonomiktir, hafiftir, ağızın belirli alanlarına dayalı bir renk kodlama sistemi sunar.
- Silikon Saplar son derece ısıya dayanıklı malzemeden üretilmektedir.
- Silikon Gracey Set sizlere 4 Farklı set halinde sunulmaktadır.
(Standart Set, Rigid Set, Makro Set, Mini Set)

(SET: PR200)

Set içeriği

| | | |
|----------------|------------------------|--------------|
| 1/2 - ANTERIOR | 7/8 - BUCCAL / LINGUAL | 17/18 McCALL |
| 3/4- ANTERIOR | 9/10- BUCCAL / LINGUAL | MINİ SICKLE |
| 5/6- ANTERIOR | 11/12- MESIAL / MOLARS | 23 WILLIAMS |



1/2
Gracey
PR071

3/4
Gracey
PR072

5/6
Gracey
PR073

7/8
Gracey
PR074

11/12
Gracey
PR075

13/14
Gracey
PR076

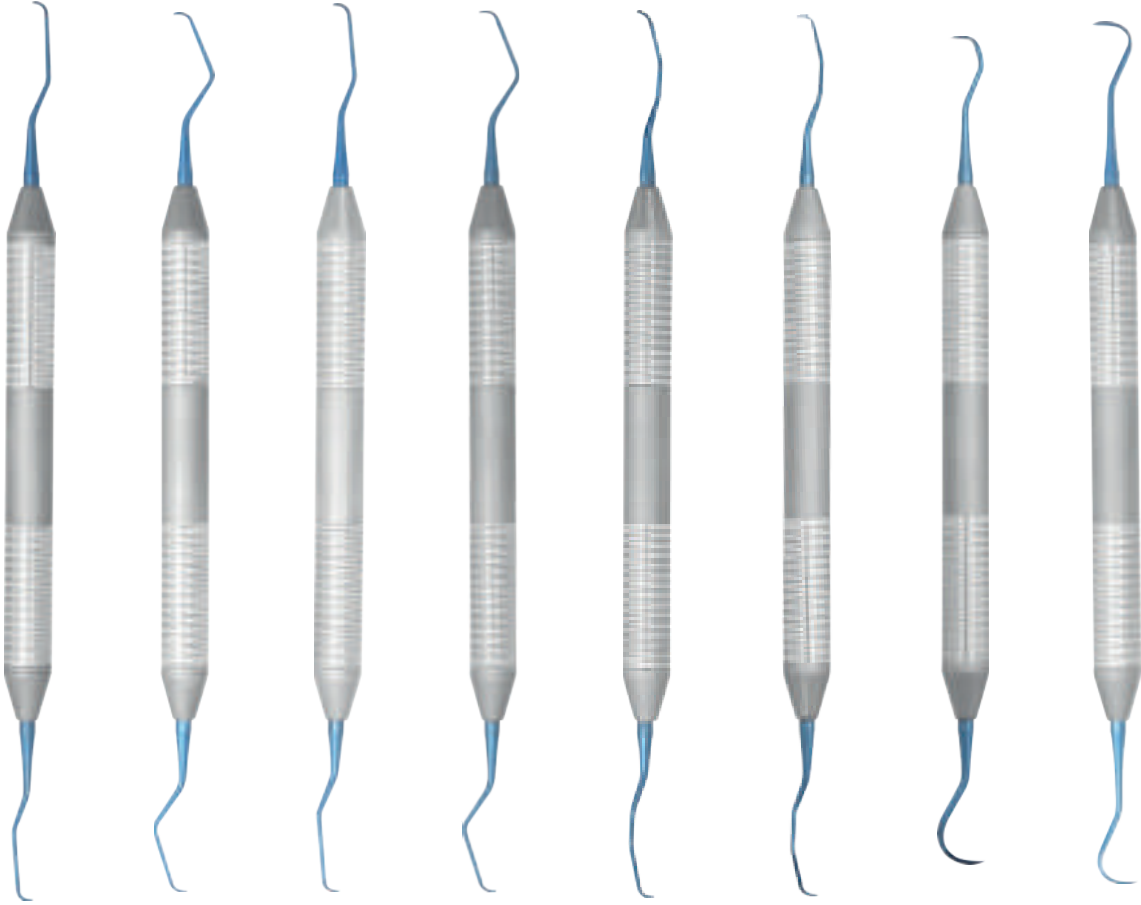
17/18
McCall
PR077

Mini
Sickle
PR078

23
Williams
PR079

TİTANYUM İMPLANT SCALERS (PR300)

- İnce eleme ve bilenmiş titanyum işlemi ile kesim kenarları optimize edilmiş keskinliğe sahiptir.
- İmplant bakımı için geliştirilmiş özellikleri, kalkülüs ve biyofilmin çıkarılması mümkündür.
- İmplantlar ve abutmentler olarak aynı titanyum alaşımından yapılmış çalışma uçları, bu hassas yüzeyler üzerinde paslanmaz çelikten daha yumuşaktır.
- Hassas çalışma uçları, hasta konforunu artırarak periodontal ceplere daha fazla erişim sağlarken, geliştirilmiş ergonomi ve görünürlük, diş hekimlerinin en iyi performansı göstermelerine yardımcı olur.



1/2
Graceey
PR080

3/4
Graceey
PR081

5/6
Graceey
PR082

7/8
Graceey
PR083

11/12
Graceey
PR084

13/14
Graceey
PR085

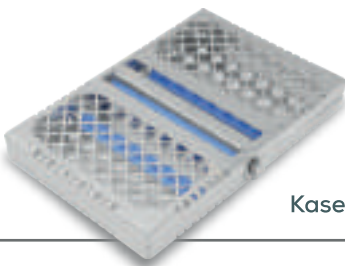
U15/30
Graceey
PR086

H6/H7
Graceey
PR087

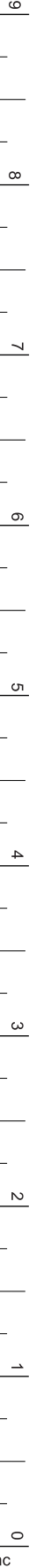
ÖZEL KASETLERLE SETİNİZİ OLUŞTURUN

1/2 - Graceey Mini Five Scalars
3/4 - Graceey Mini Five Scalars
5/6 - Graceey Mini Five Scalars
7/8 - Graceey Mini Five Scalars

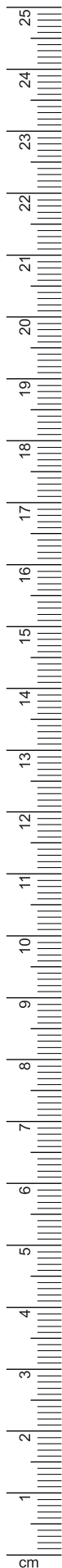
11/12 - Graceey Mini Five Scalars
13/14 - Graceey Mini Five Scalars
U15/30 - Mini Five Scalars
H6/H7 - Mini Five Scalars



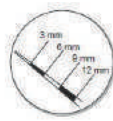
Kaset: OD200



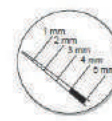
PERIODONTAL SONDLAR
PERIODONTAL PROBES



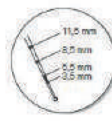
**CP-11
PS001**
160 mm



**CP-12
PS002**
160 mm



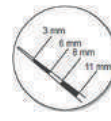
**CP-15UNC
PS003**
160 mm



**WHO
PS004**
160 mm



**CP-10
PS005**
160 mm



**NABER
PS006**
160 mm



**CP-15
MARYLAND
PS007**
160 mm



**WILLIAMS
PS008**



**MERRIT A
PS009**



**MERRIT B
PS010**



**GOLDMAN-FOX
PS011**



**UNIVERSITY
OF MICHIGAN
PS012**



**26 G
PS013**



1
OCHSENBEIN-1
PD027
165 mm



2
OCHSENBEIN-2
PD028
165 mm



2
TG CHISELS
PD029
170 mm



OCHSENBEIN-3
PD030
170 mm



OCHSENBEIN-4
PD031
170 mm



1
FEDI
PD032
175 mm



2
FEDI
PD033
175 mm



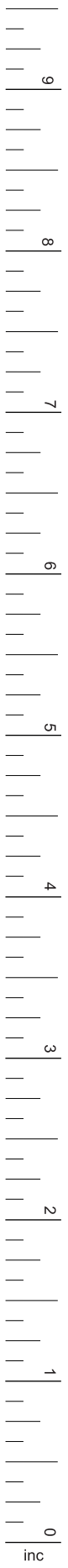
3
FEDI
PD034
170 mm

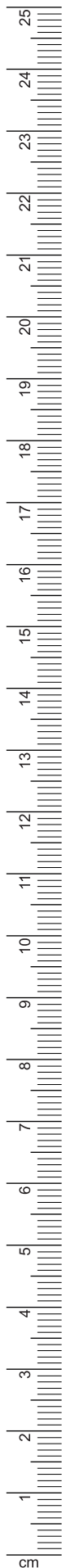


4
OCHSENBEIN
PD035
170 mm



RHODES
BACK ACTION
PD036
170 mm





U15/J30
KT001



J14/15
KT002



NVO
KT003



NV11/12
KT004



NV13/14
KT005



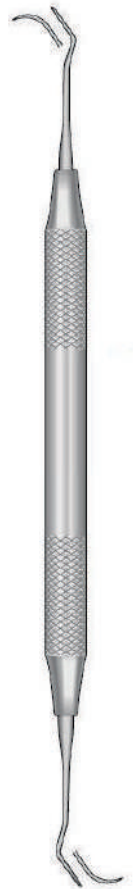
2/3
TAYLOR
KT006



204
KT007



204S
KT008



204SD
KT009



2/3
KT010



6
CRANE-CAPLAN
KT011



7/8
YOUNGER-GOOD
KT012



23/24
RULE
KT013



17/18
I. UNIVERSITY
KT014



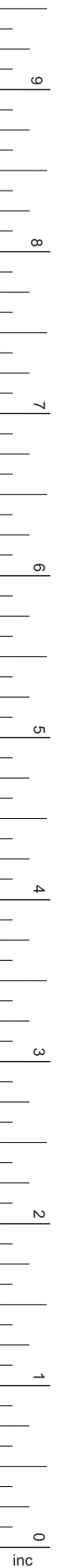
U15/J33
TOWNER-JAQUETTE
KT015



H5/J33
TOWNER-JAQUETTE
KT016



H6/H7
TOWNER
JAQUETTE
KT017



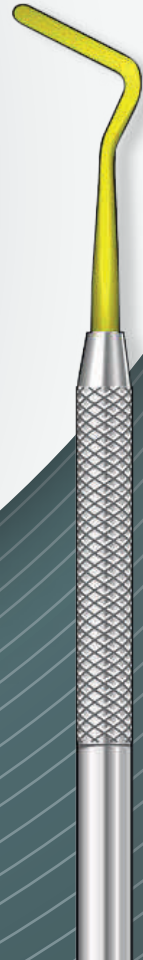


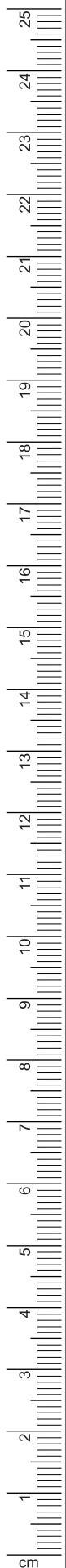
Siz
Tasarlayın
Biz
Üretelim

ODC
SURGICAL INSTRUMENTS



KOMPOZİT ALETLER
COMPOSITE INSTRUMENTS





1
KA01E

FELT



2
KA02E

FELT



3
KA03E

FELT



4
KA04E

FELT



5
KA05E

FELT



6
KA06E

FELT



4/5
KA07E

FELT



1
KA08E

GOLDSTEIN



2
KA09E

GOLDSTEIN



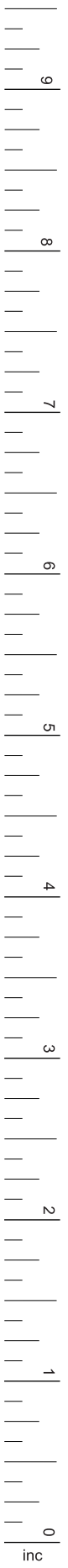
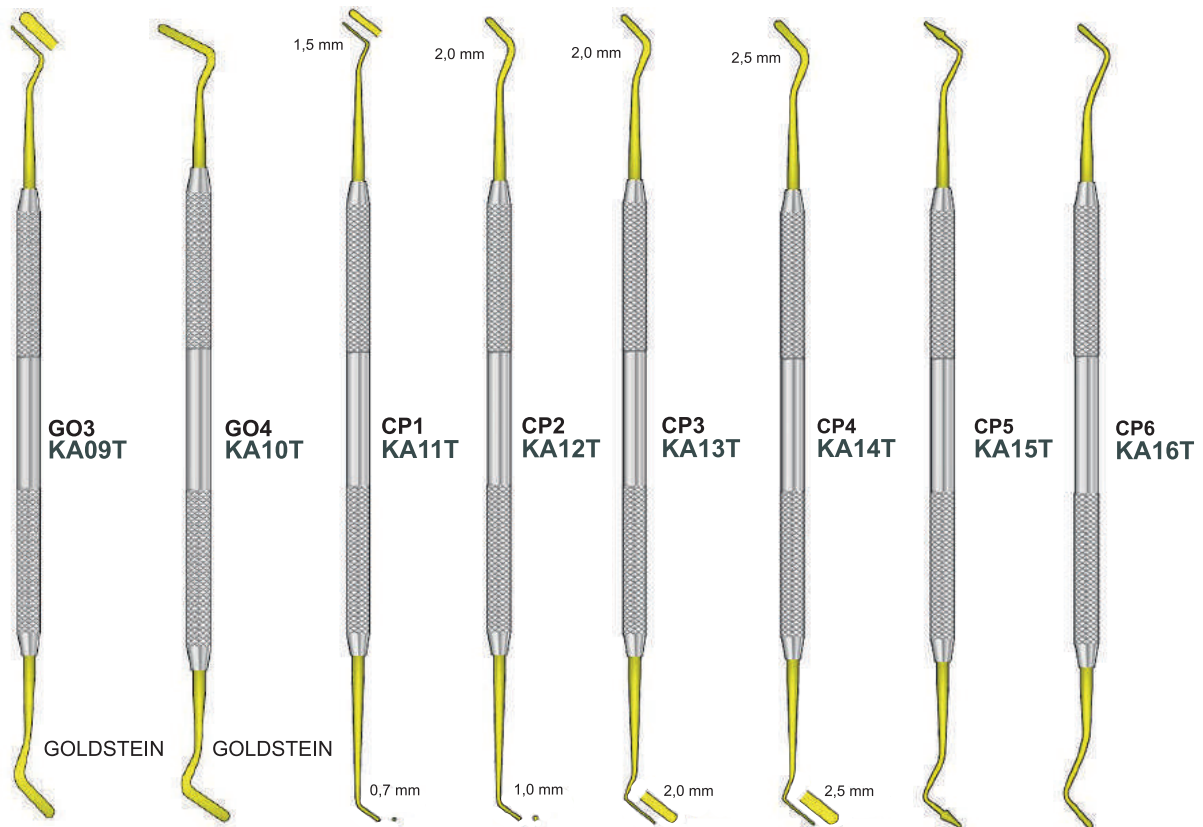
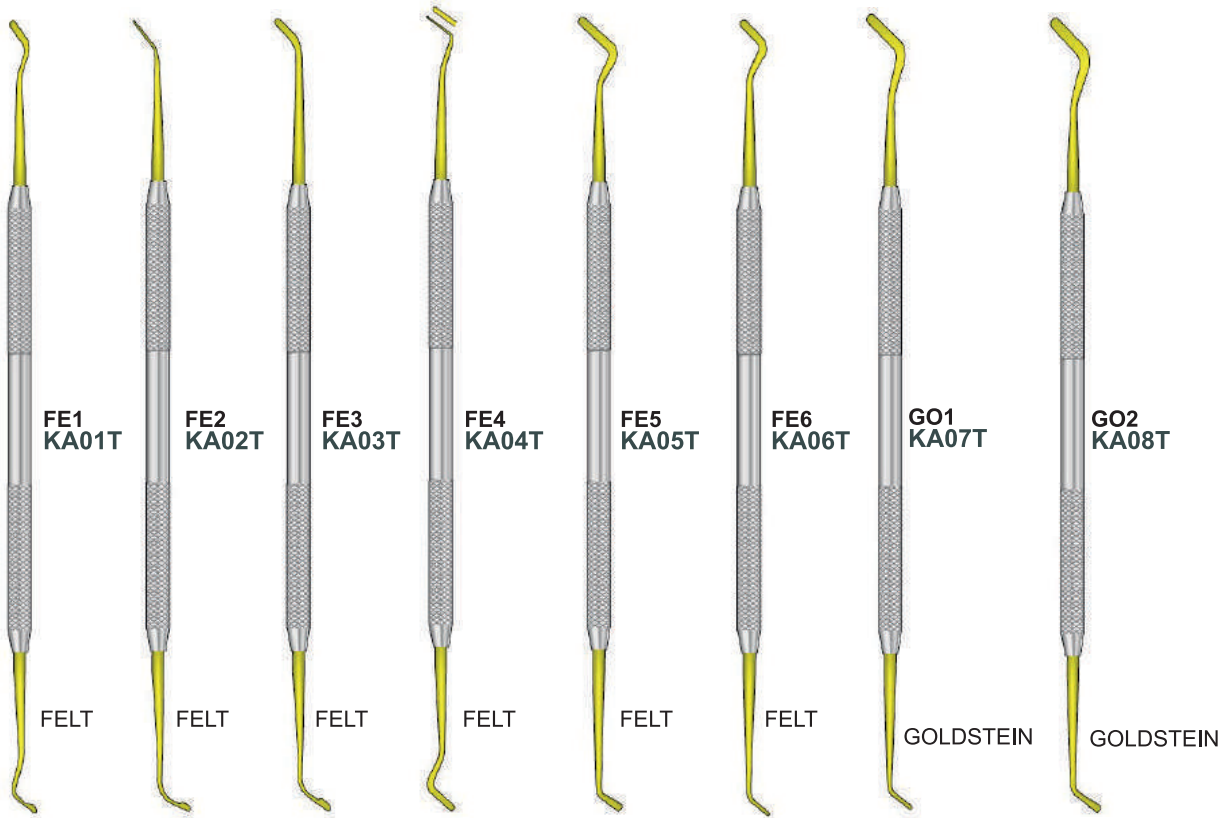
3
KA10E

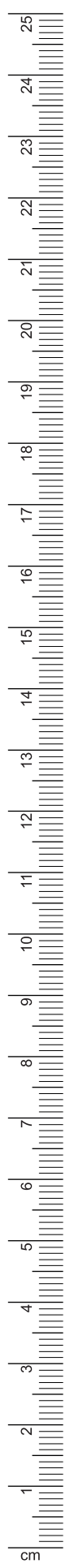
GOLDSTEIN



4
KA11E

GOLDSTEIN





1
KA001



2
KA002



3
KA003



1
KA004
125 mm



1
HOLLENBACH
KA005
165 mm



1/2
HOLLENBACH
KA006
165 mm



3
HOLLENBACH
KA007
165 mm

EKSKAVATÖR
EXCAVATORS



0
EV001



1
EV002



2
EV003



3
EV004



4
EV005



1
EV006



2
EV007



KA008



**USC
KA009**



**FRAHM
KA010**



**1/2
KA011**



**4/5
KA012**



**W.A.C.D.
KA013**



**3/6
KA014**



KA015



KA016



KA017



KA018



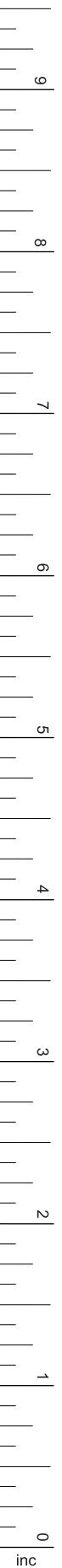
KA019

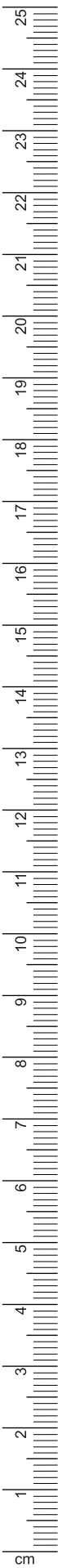


KA020



KA021





Tırtıklı Serrated

Düz Smooth



1
KA022



2
KA023



3
KA024



1L
KA025



2L
KA026



3L
KA027



WARD
KA028



WARD
KA029



1
KA030



2
KA031



3
KA032



4
KA033



5
KA034



1
KA035



2
KA036



3
KA037



KA038



KA039



**WESTCOTT
KA040**



**WESTCOTT
KA041**



KA042



KA043



KA044



**WHITE
n°28
KA045**



**WHITE
n°29
KA046**



**WHITE
n°32
KA047**



**WHITE
n°33
KA048**



**WHITE
n°34
KA049**



**WHITE
Dippio
KA050**

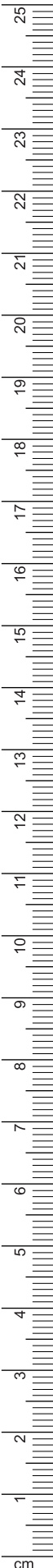


**WHITE
Dippio
KA051**



**BENNET
170 mm
KA052**





26
BLACK
KA053



27
BLACK
KA054



28
BLACK
KA055



29
BLACK
KA056



1M
KA057



2M
KA058



3M
KA059



4M
KA060



5M
KA061



6M
KA062



SP001
180 mm



SP002
180 mm



SP003
180 mm



SP004
200 mm



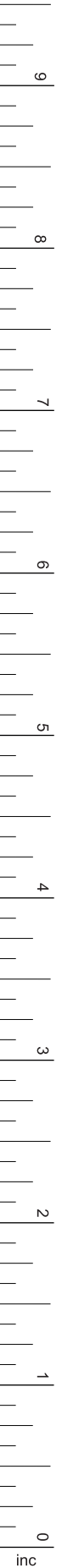
SP005
140 mm



SP006
180 mm



SP007
185 mm



RD100



26
IVORY
RD001



30
IVORY
RD005



27
IVORY
RD002



31
IVORY
RD006



28
IVORY
RD003



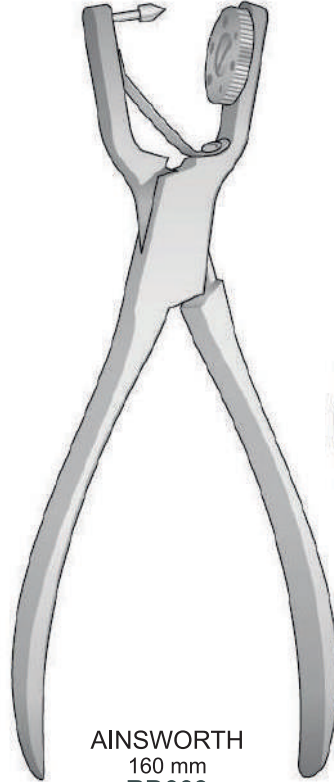
51
IVORY
RD007



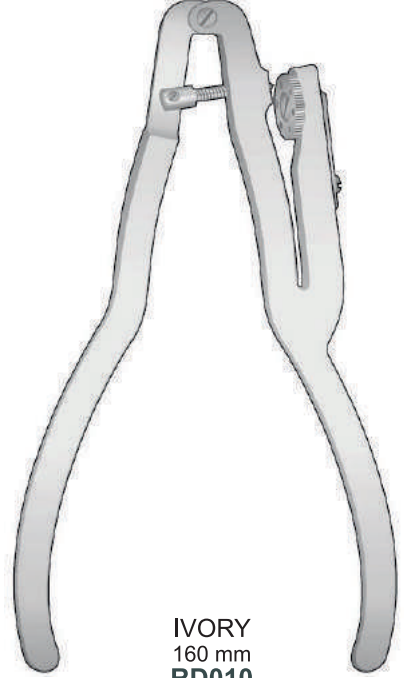
29
IVORY
RD004



60
IVORY
RD008



AINSWORTH
160 mm
RD009



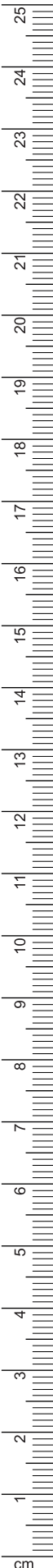
IVORY
160 mm
RD010



95x115mm
Yetişkin
Adults
RD011



80x75mm
Çocuk
Children
RD012

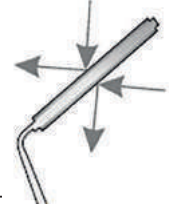




| | |
|-------|--------------|
| AY001 | #3 - Ø 18 mm |
| AY002 | #4 - Ø 22 mm |
| AY003 | #5 - Ø 24 mm |



AY004 #4 - Ø 22 mm



MEGA DUO
RHODIUM n.4
Her iki tarafı rodyum kaplama
Both sides Rhodium-coated

SOLID



AY005
Basit Gövde
120 mm

AY006
Konik Soket
120 mm



AY007
Basit Gövde
125 mm

AY008
Konik Soket
125 mm



HOLLOW



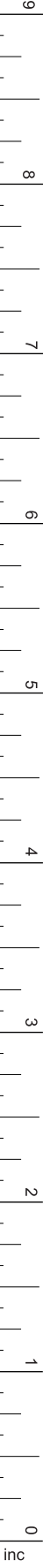
AY009
120 mm

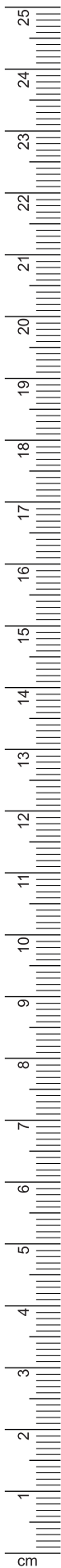


AY010
120 mm



AY011
135 mm





23
PB001



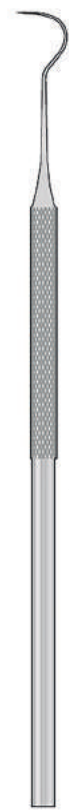
11
PB002



6
PB003



9
PB004



2
PB005



10
PB006



12
PB007



6A
PB008



8A
PB009



17A
PB010



3A
PB011



3
PB012



AT001



AT002

METAL TİP



Ø 35 mm
h. 35 mm
AT003

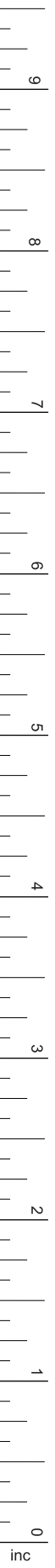


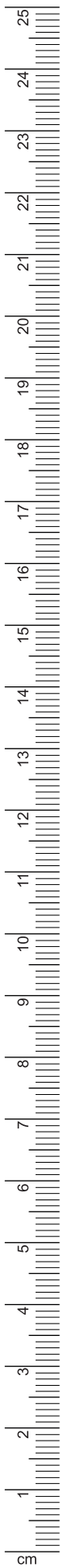
AT004
170 mm



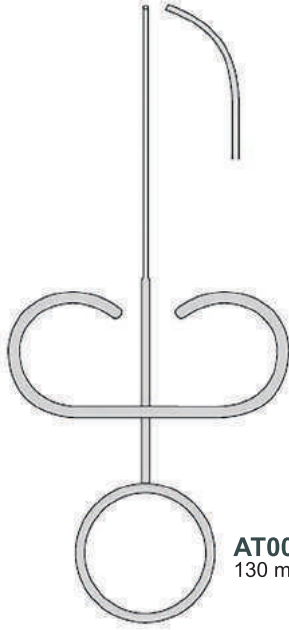
AT005
160 mm

OTOKLAVLANABİLİR
PLASTİK TİP



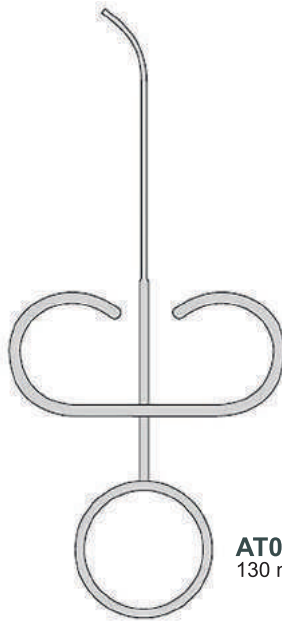


YUKARI EĞRİ
CURVED UP
Ø 0,9 mm



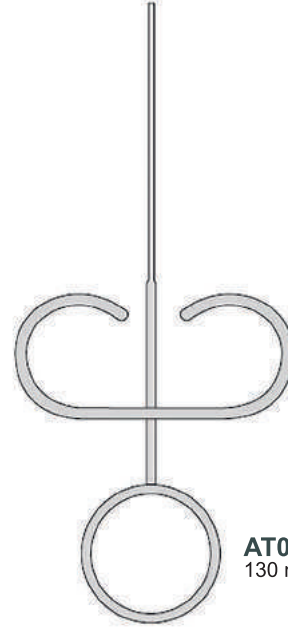
AT006
130 mm

YANA EĞRİ
CURVED TO SIDE
Ø 0,9 mm



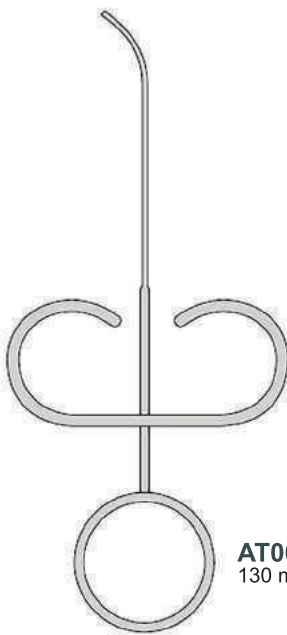
AT007
130 mm

DÜZ
STRAIGHT
Ø 1,2 mm



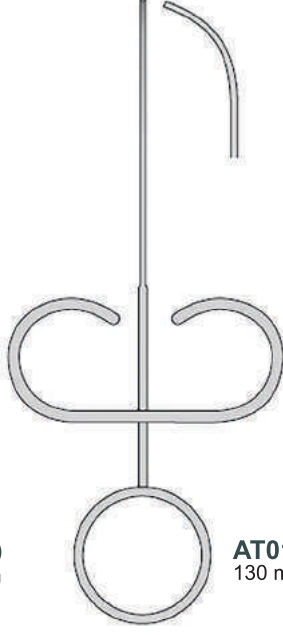
AT008
130 mm

YANA EĞRİ
CURVED TO SIDE
Ø 1,2 mm



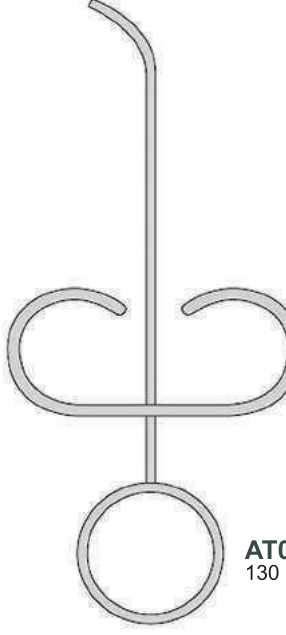
AT009
130 mm

YUKARI EĞRİ
CURVED UP
Ø 1,2 mm



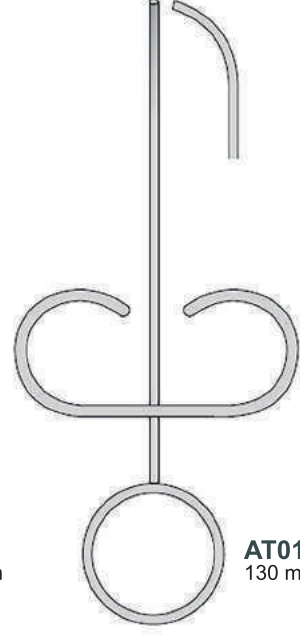
AT010
130 mm

YANA EĞRİ
CURVED TO SIDE
Ø 1,8 mm



AT011
130 mm

YUKARI EĞRİ
CURVED UP
Ø 1,8 mm



AT012
130 mm

Büyük Ağı, 12 Parça
Molars, 12 pieces



1
MT015



2
MT017



40/3
MT019

Küçük Ağı, 12 Parça
Premolars, 12 pieces



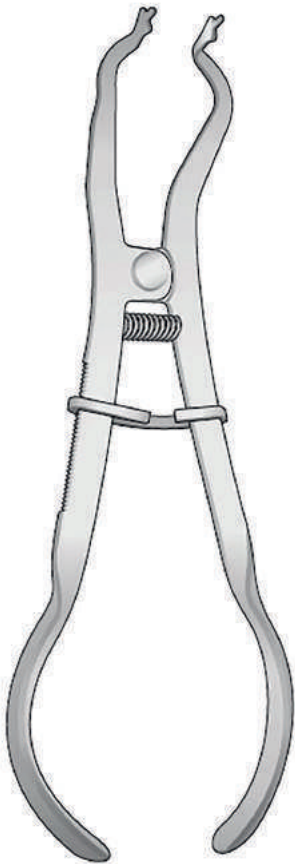
41/4
MT016



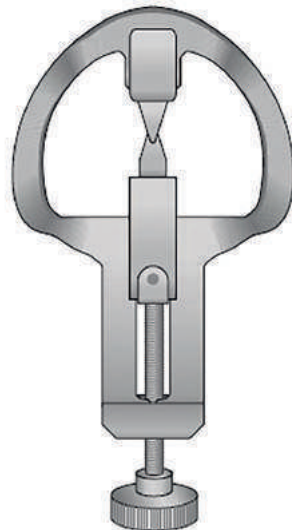
41/5
MT018



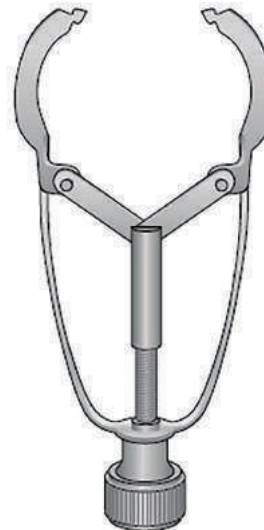
41/6
MT020



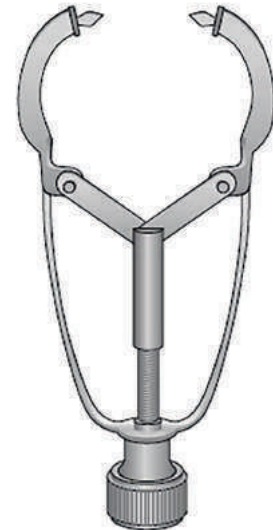
IVORY
MT021
170 mm



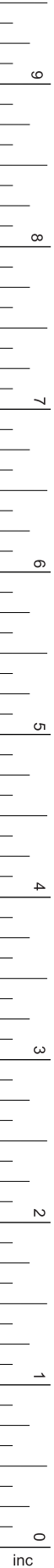
14
IVORY
MT022



1
IVORY
MT023



12
IVORY
MT024



Büyük Ağı, 12 Parça
Molars, 12 pieces



7
MT025



8
MT026



9
MT027



10
MT028

Küçük Ağı, 12 Parça
Premolars, 12 pieces



11
MT029



12
MT030



13
MT031

TOFFLEMIRE
Evrensel
Unversel



1
MT032



2
MT033



3
MT034



MT035 5 mm x 1mt

MT036 6 mm x 1mt

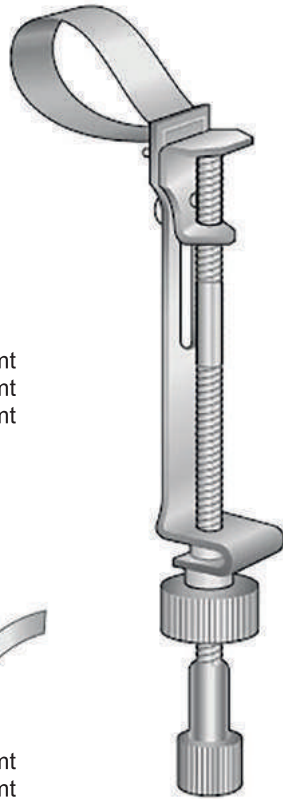
MT037 7 mm x 1mt



MT038 5 mm x 5mt

MT039 6 mm x 5mt

MT040 7 mm x 5mt



8
IVORY

MT041
5 mm

MT042
6 mm

MT043
7 mm



1
SAĞ
RİHT



2
SOL
LEFT

1 - 2
NYSTRÖM
MT044

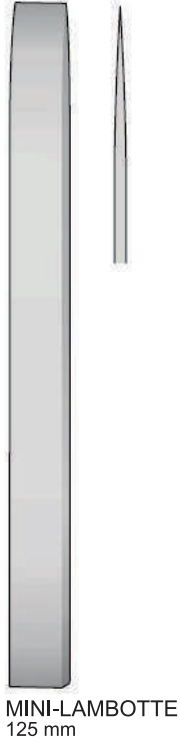
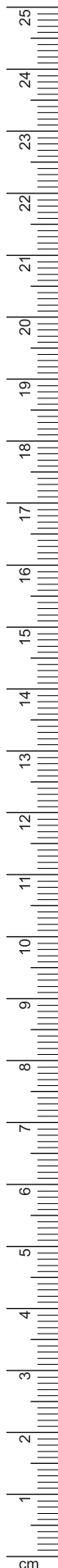


TOFFLEMIRE
MT045
Evrensel



| CERRAHI
| SURGICAL

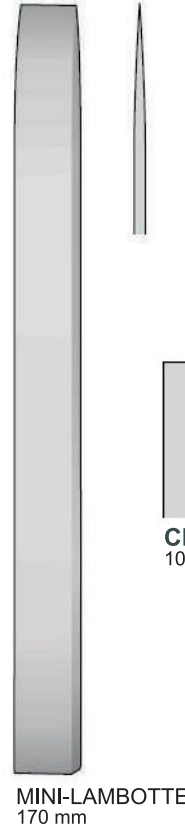




CR001
3 mm

CR002
4 mm

CR003
6 mm

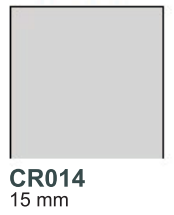
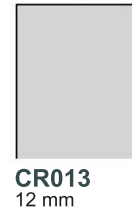


CR008
3 mm

CR009
4 mm

CR010
6 mm

CR011
8 mm



TEK TARAFLI KESİM



ÇİFT TARAFLI KESİM





140 mm



CR022
4 mm



CR023
6 mm



CR024
8 mm



CR025
10 mm



CR026
12 mm



140 mm



CR027
4 mm



CR028
6 mm



CR029
8 mm



CR030
10 mm



CR031
12 mm

9 mm



CR032
170 mm

Esnek
Flexible

3 mm



CR033
155 mm

6 mm



CR034
155 mm

9 mm



CR035
155 mm



KRAMER-NEVINS
175 mm



55
CR036

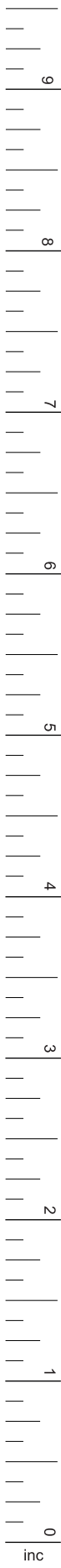


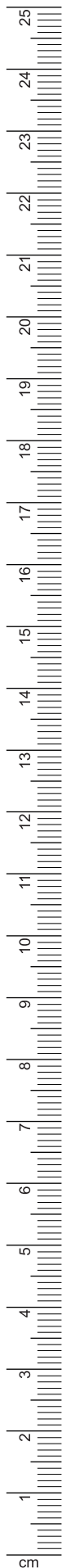
75
CR037

6 mm



CR038
180 mm





CR039
3 mm

CR040
4 mm

CR041
5 mm

CR042
6 mm



CR043
3 mm

CR044
4 mm

CR045
5 mm

CR046
6 mm



CR047
3 mm

CR048
4 mm

CR049
5 mm



CR052
3 mm

CR053
4 mm

CR054
3 mm

CR055
6 mm

CR056
7 mm



CR057
2 mm

CR058
4 mm

CR059
6 mm



CR060
4 mm

CR061
6 mm

CR062
8 mm



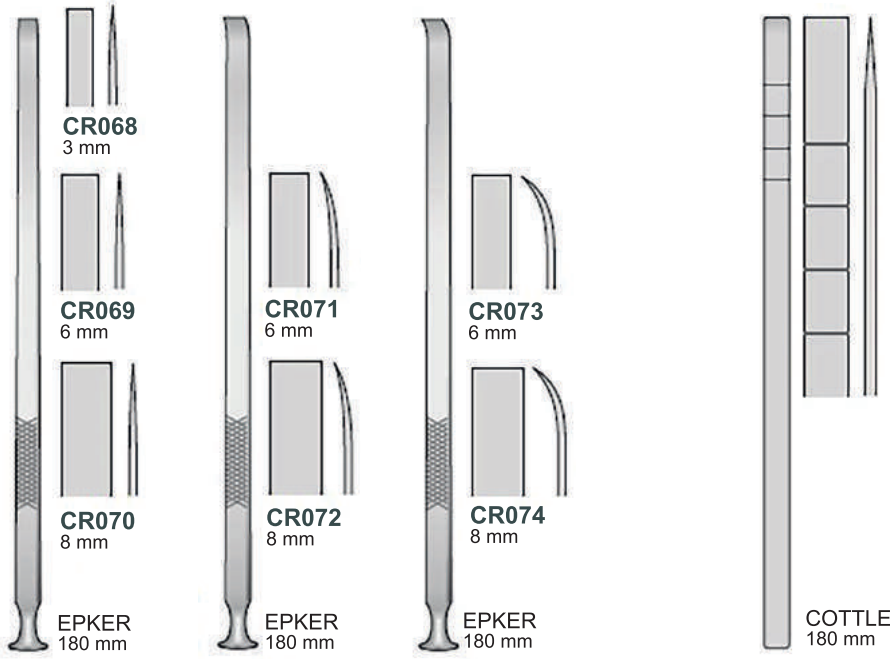
CR064
2 mm

CR066
5 mm

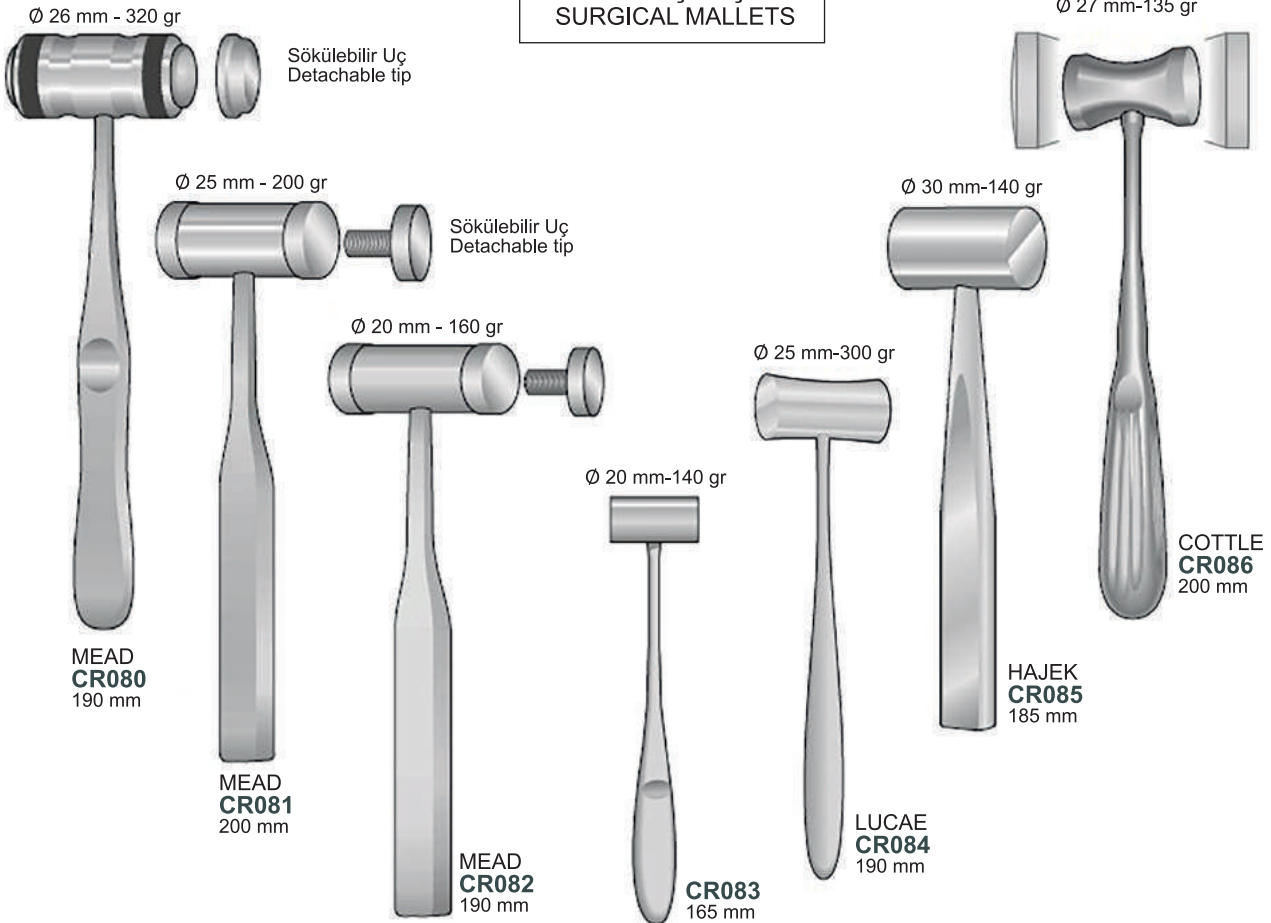
CR065
3 mm

CR067
7 mm





**CERRAHİ ÇEKİÇLER
SURGICAL MALLETS**



KEMİK GENİŞLETİCİLER
BONE EXPANDERS



CR087
130 mm



CR088
130 mm



CR089
130 mm



CR090
130 mm

TÜNEL AÇMA ALETLERİ
TUNNELING INSTRUMENTS



1/2ML
CR091



1/2ML
CR092



CR093



CR094



CR095



CR096

| 1 | Ölçü |
|------|--------|
| 0 | Ø 1.60 |
| 7.5 | Ø 1.80 |
| 10 | Ø 2.00 |
| 13.5 | Ø 2.40 |
| 15.5 | Ø 3.60 |

| 2 | Ölçü |
|------|--------|
| 0 | Ø 1.90 |
| 7.5 | Ø 2.20 |
| 10 | Ø 2.35 |
| 13.5 | Ø 3.60 |
| 15.5 | Ø 4.40 |
| 21.5 | Ø 4.50 |

| 3 | Ölçü |
|------|--------|
| 0 | Ø 2.80 |
| 7.5 | Ø 3.20 |
| 10.5 | Ø 3.35 |
| 13.5 | Ø 3.60 |
| 21 | Ø 4.40 |

| 4 | Ölçü |
|------|--------|
| 0 | Ø 3.10 |
| 7.5 | Ø 3.70 |
| 10.5 | Ø 3.90 |
| 15.5 | Ø 4.30 |

| 5 | Ölçü |
|------|--------|
| 0 | Ø 3.90 |
| 10 | Ø 5.00 |
| 13 | Ø 5.20 |
| 20,5 | Ø 6.30 |

| 6 | Ölçü |
|----|--------|
| 0 | Ø 5.50 |
| 10 | Ø 6.20 |
| 13 | Ø 6.30 |

1
Ø 1.6 mm



CR097
155 mm

2
Ø 1.9 mm



CR098
155 mm

3
Ø 2.8 mm



CR099
155 mm

4
Ø 3.10 mm



CR100
155 mm

5
Ø 3.90 mm

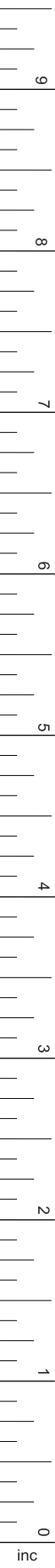


CR101
155 mm

6
Ø 5.50 mm



CR102
155 mm



| 1 | Ölçü | 2 | Ölçü | 3 | Ölçü | 4 | Ölçü | 5 | Ölçü |
|----|--------|----|--------|----|--------|----|--------|----|--------|
| 0 | Ø 1.50 | 0 | Ø 2.10 | 0 | Ø 2.60 | 0 | Ø 3.00 | 0 | Ø 3.50 |
| 5 | Ø 1.90 | 5 | Ø 2.60 | 5 | Ø 3.00 | 5 | Ø 3.50 | 5 | Ø 3.90 |
| 8 | Ø 2.20 | 8 | Ø 2.80 | 8 | Ø 3.30 | 8 | Ø 3.80 | 8 | Ø 4.20 |
| 10 | Ø 2.40 | 10 | Ø 3.00 | 10 | Ø 3.50 | 10 | Ø 4.00 | 10 | Ø 4.40 |
| 12 | Ø 2.60 | 12 | Ø 3.20 | 12 | Ø 3.70 | 12 | Ø 4.20 | 12 | Ø 4.60 |
| 14 | Ø 2.80 | 14 | Ø 3.40 | 14 | Ø 3.90 | 14 | Ø 4.40 | 14 | Ø 4.80 |

1
Ø 1.6 mm



CR103
155 mm

2
Ø 1.9 mm



CR104
155 mm

3
Ø 2.8 mm



CR105
155 mm

4
Ø 3.10 mm



CR106
155 mm

5
Ø 3.90 mm



CR107
155 mm

6
Ø 5.50 mm



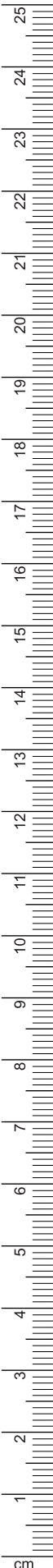
CR108
155 mm

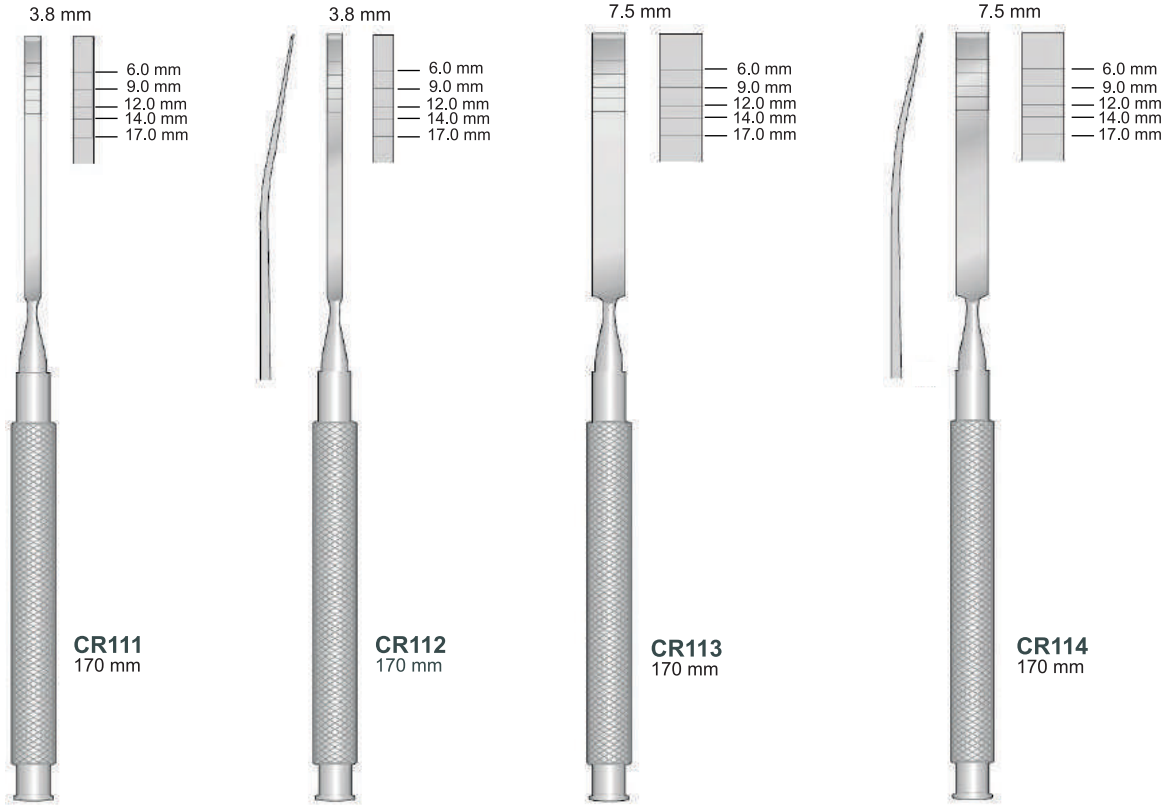


CR109
155 mm

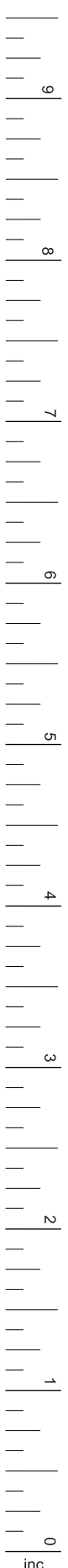


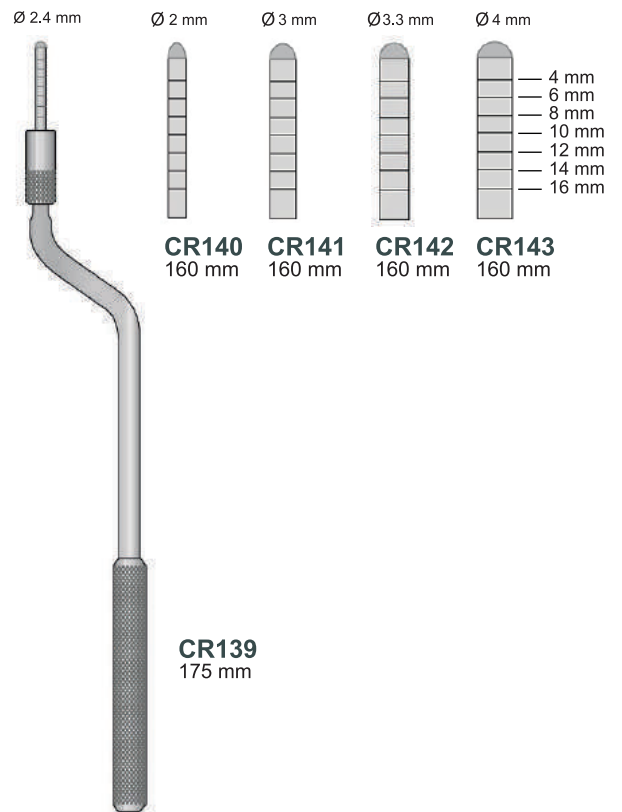
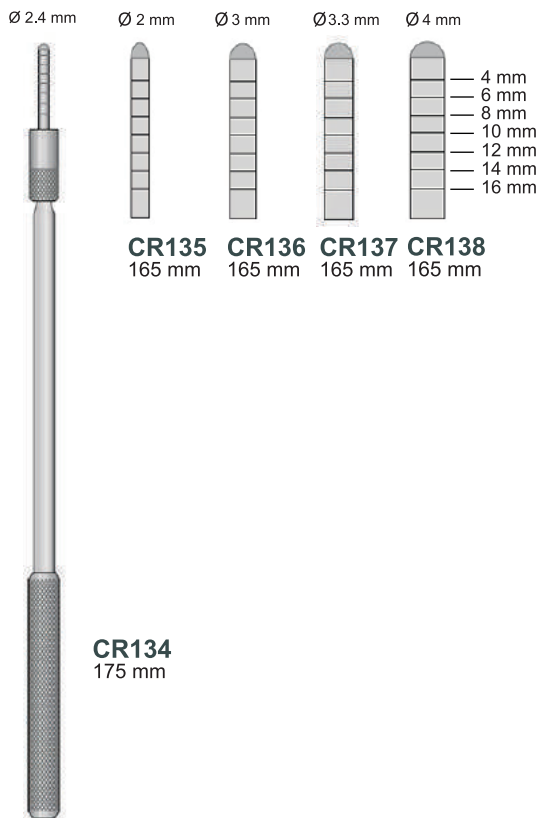
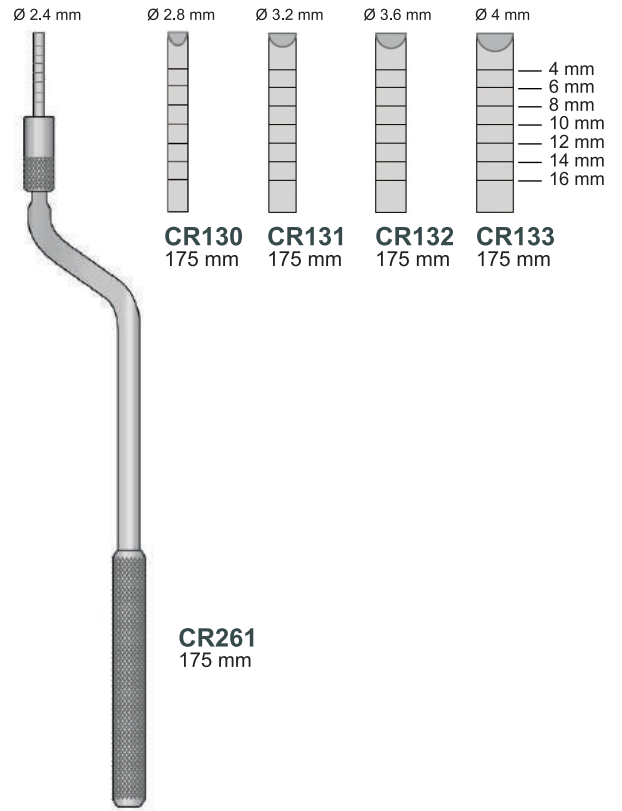
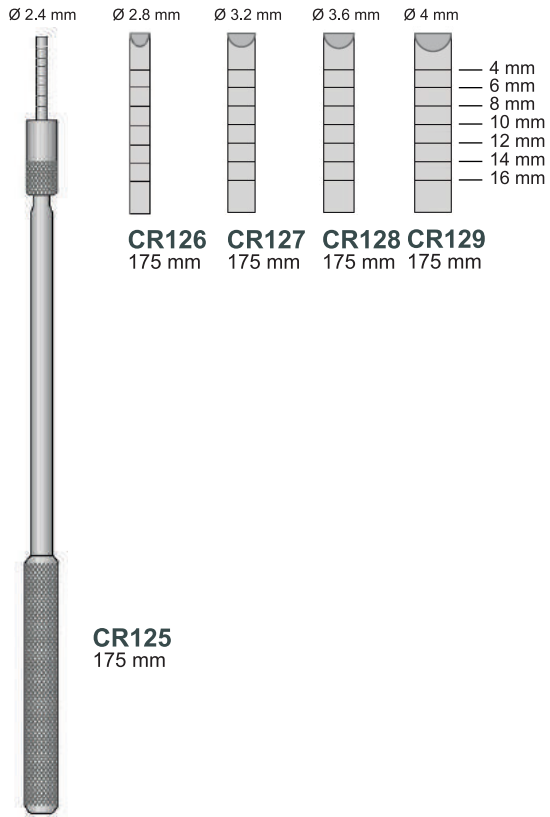
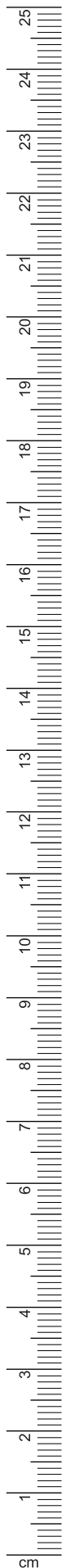
CR110
155 mm

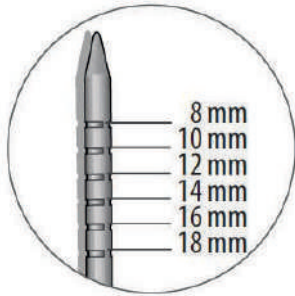




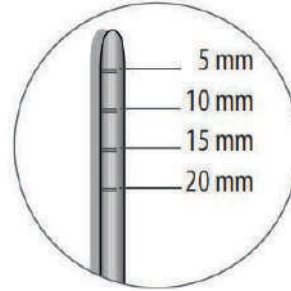
Sinüsliift Küretleri
Sinuslift Kurettens







Kanal
Geniřletici
Alet /
Dilator



Yayıcı
Alet /
Spreader

Int.
Ext.

Konveks Tip
Convex Tip

A - Tip

B - Tip

Ø 2 mm

Ø 3 mm

Ø 3.3 mm

Ø 4 mm

Ø 3 mm

Ø 4 mm

Ø 5 mm



CR144
145 mm



CR145
145 mm



CR146
145 mm



CR147
145 mm



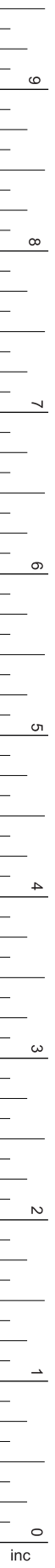
CR148
145 mm

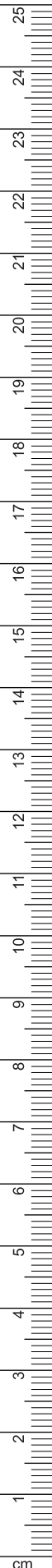


CR149
145 mm

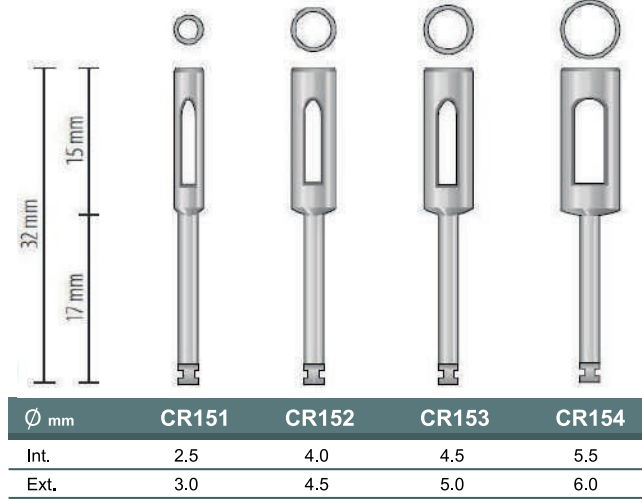


CR150
145 mm

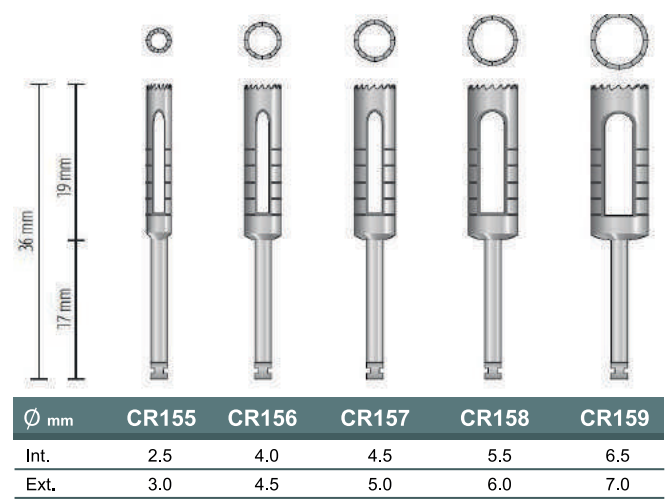




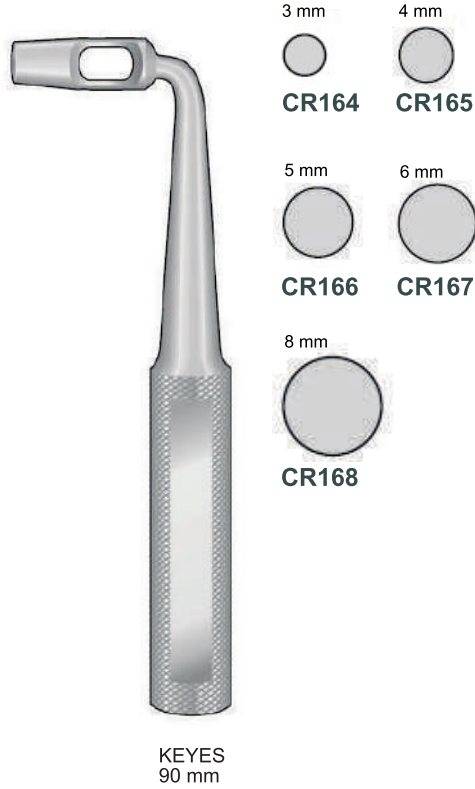
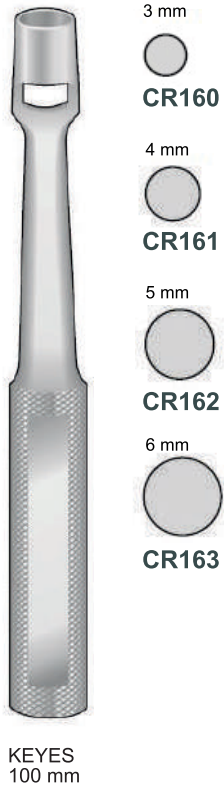
Doku İçin
For Tissue
Dişsiz
Non Serrated



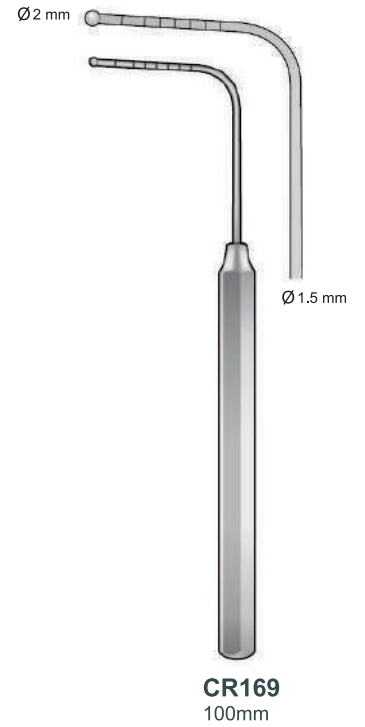
Kemik İçin
For Bone
Dişli
Serrated



Doku Pançları
Tissue Punches



İmplant Derinlik Ölçer
Implant depth gauge with ball end

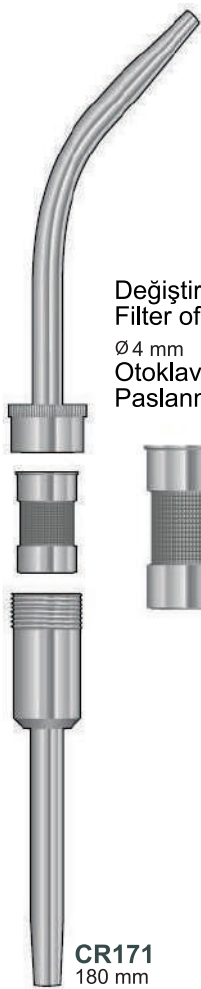


Kemik Yuvası
Bone Well



Paslanmaz Çelik
Stainless Steel

CR170
35 mm

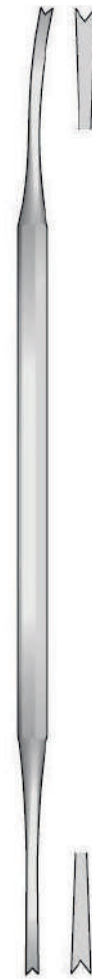


Değişirme Filtresi
Filter of replacement
Ø4 mm
Otoklavlanabilir
Paslanmaz Çelik

CR171
180 mm



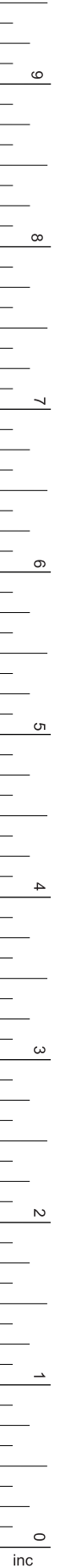
CR172
185 mm

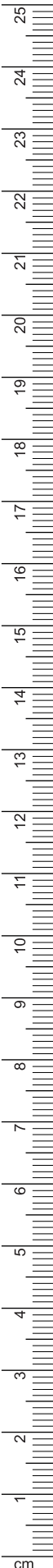


LUNIATSCHEK
CR173
170 mm

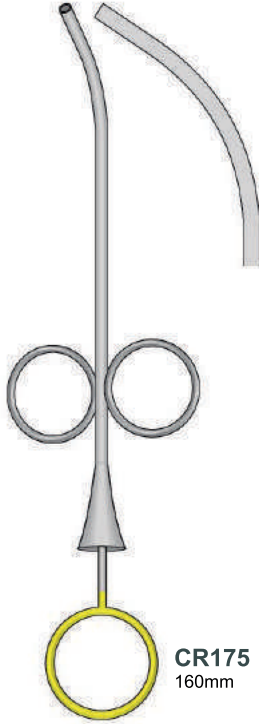


CR174
180 mm



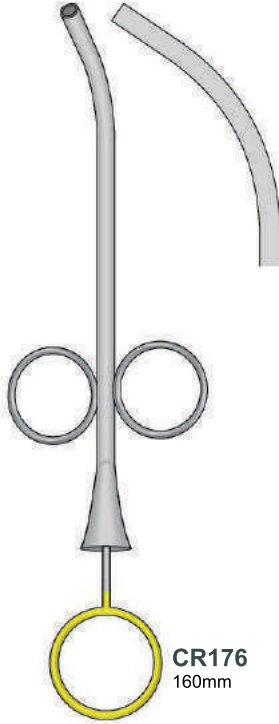


Ø int. 2.5 mm
Ø ext. 3.5 mm



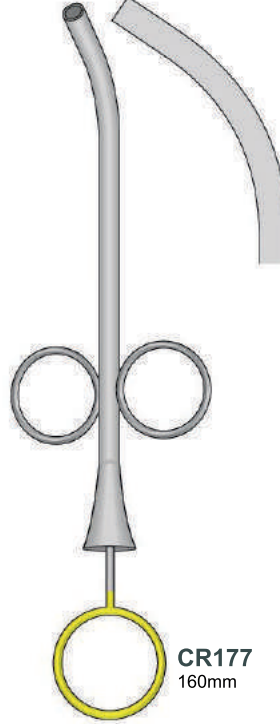
CR175
160mm

Ø int. 3.5 mm
Ø ext. 4.5 mm



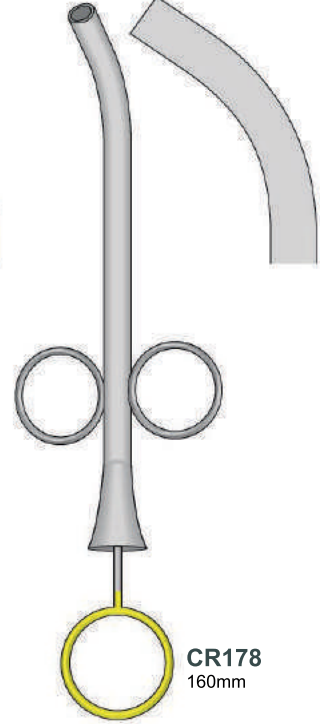
CR176
160mm

Ø int. 4.4 mm
Ø ext. 5.5 mm



CR177
160mm

Ø int. 6 mm
Ø ext. 7 mm



CR178
160mm



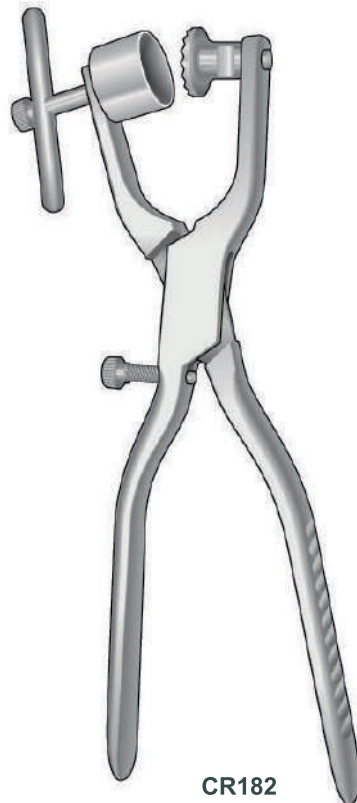
CR179
Alt / Titanium
Lower / Titanium



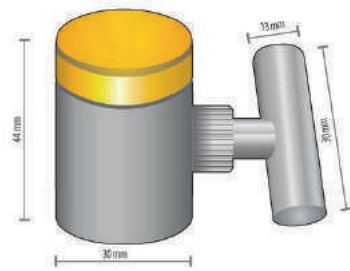
CR180
Üst / Titanium
Upper / Titanium



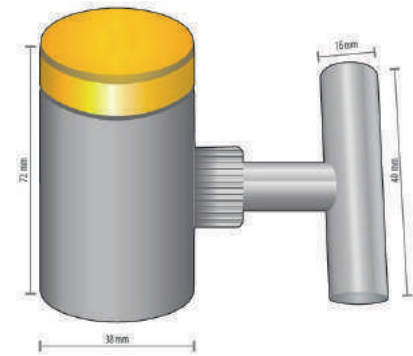
CR181
Sap / Vidalı
Handle / With screw



CR182



CR183
SMALL



CR184
LARGE



Dişsiz Tip
Non Serrated

Dişli Tip
Serrated

| | | | | | |
|--------------|-------|-------|--------------|-------|-------|
| CR185 | Ø 1.8 | Ø 2.8 | CR189 | Ø 1.8 | Ø 2.8 |
| CR186 | Ø 3.2 | Ø 3.8 | CR190 | Ø 3.2 | Ø 3.8 |
| CR187 | Ø 4.2 | Ø 4.8 | CR191 | Ø 4.2 | Ø 4.8 |
| CR188 | Ø 5.0 | Ø 5.8 | CR192 | Ø 5.0 | Ø 5.5 |

Ø 3.0 mm



CR193
155 mm

Ø 5.0 mm



CR194
155 mm

Ø 4.0 mm



CR195
155 mm

Ø 3.0 mm



CR196
155 mm

Ø 5.0 mm



CR197
155 mm

3 mm



CR198
170 mm

6 mm



CR199
170 mm

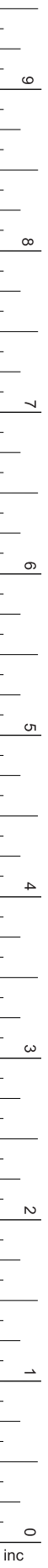
8 mm

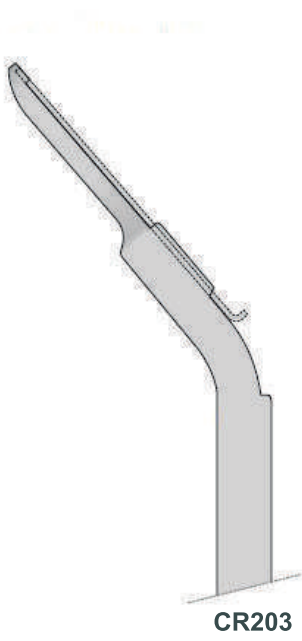
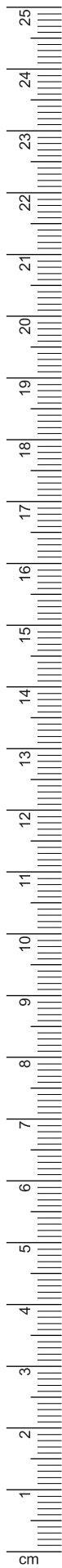


FOITZIK
140 mm

İç Ölçüm
Misura interna

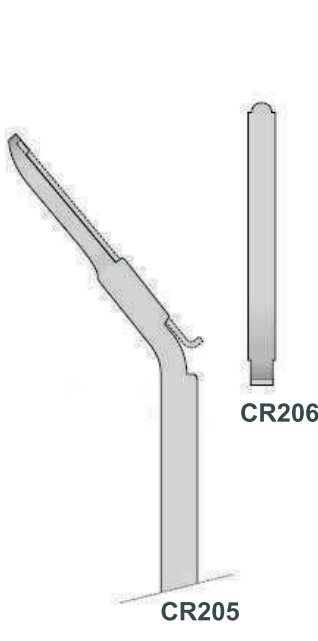
- CR200 Ø 3 mm
- CR201 Ø 4 mm
- CR202 Ø 5 mm





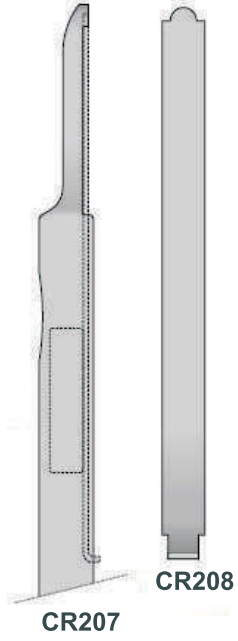
CR204

CR203



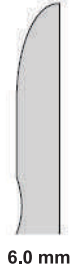
CR206

CR205



CR208

CR207



6.0 mm



CR209
170 mm

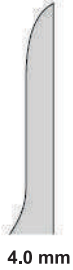


CR210
90 mm

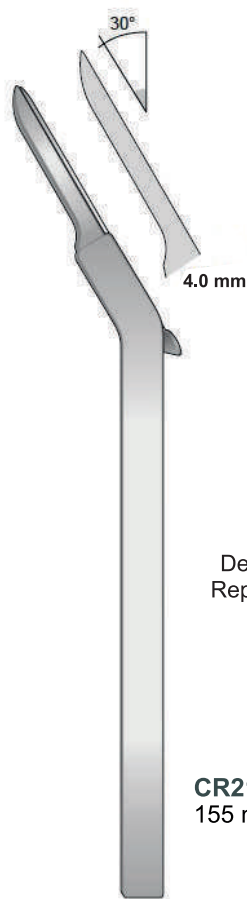
Değiştirme Bıçağı
Replacement Blade



CR211
170 mm



4.0 mm



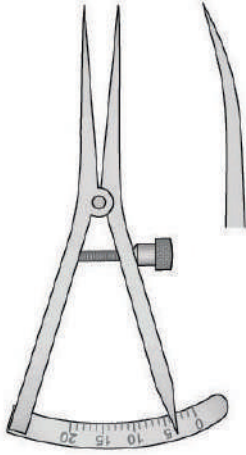
CR212
155 mm



CR213
60 mm

Değiştirme Bıçağı
Replacement Blade

Ölçüm Aralığı: 0 - 20 mm
Measuring range : 0 - 20 mm



**CASTROVIEJO
CR214
90 mm**



**CR215
100 mm**



**CR216
200 mm**



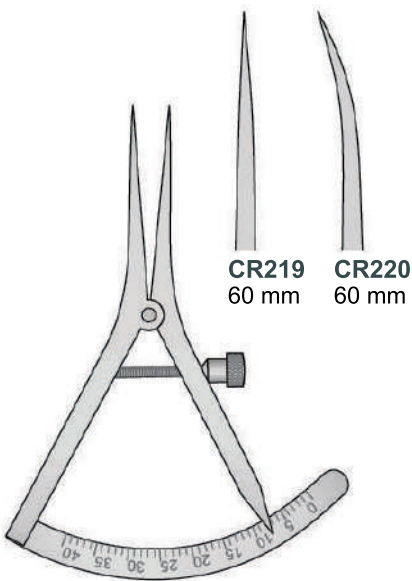
**CR217
125 mm**



**CR218
95 mm**

Ölçüm Aralığı: 0 - 80 mm
Measuring range : 0 - 80 mm

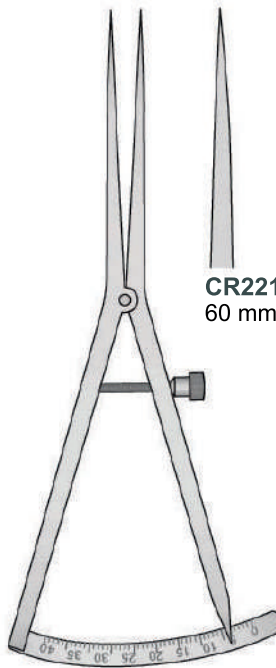
Ölçüm Aralığı: 0 - 40 mm
Measuring range : 0 - 40 mm



**CASTROVIEJO
90 mm**

**CR219
60 mm**

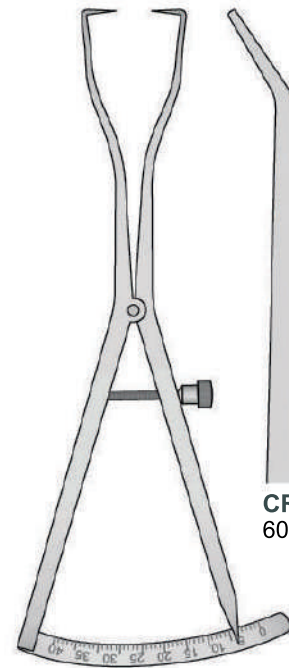
**CR220
60 mm**



**CASTROVIEJO
170 mm**

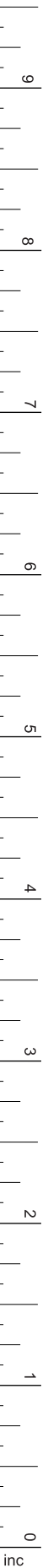
**CR221
60 mm**

**CR222
60 mm**

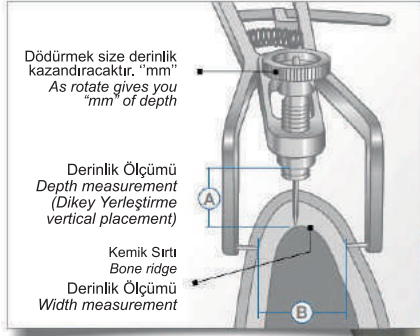


**CASTROVIEJO
170 mm**

**CR223
60 mm**

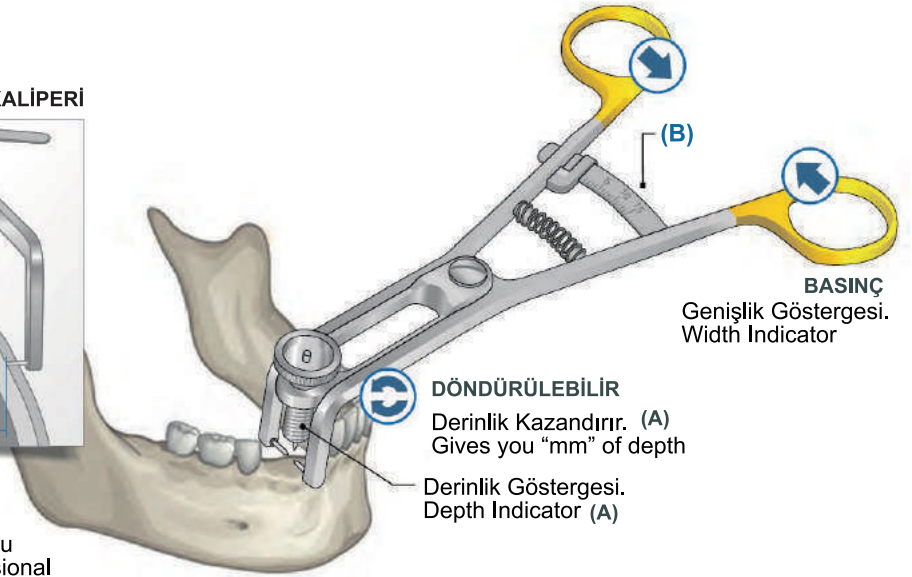


ÜÇ BOYUTLU İMPLANTOLOJİ KALİPERİ

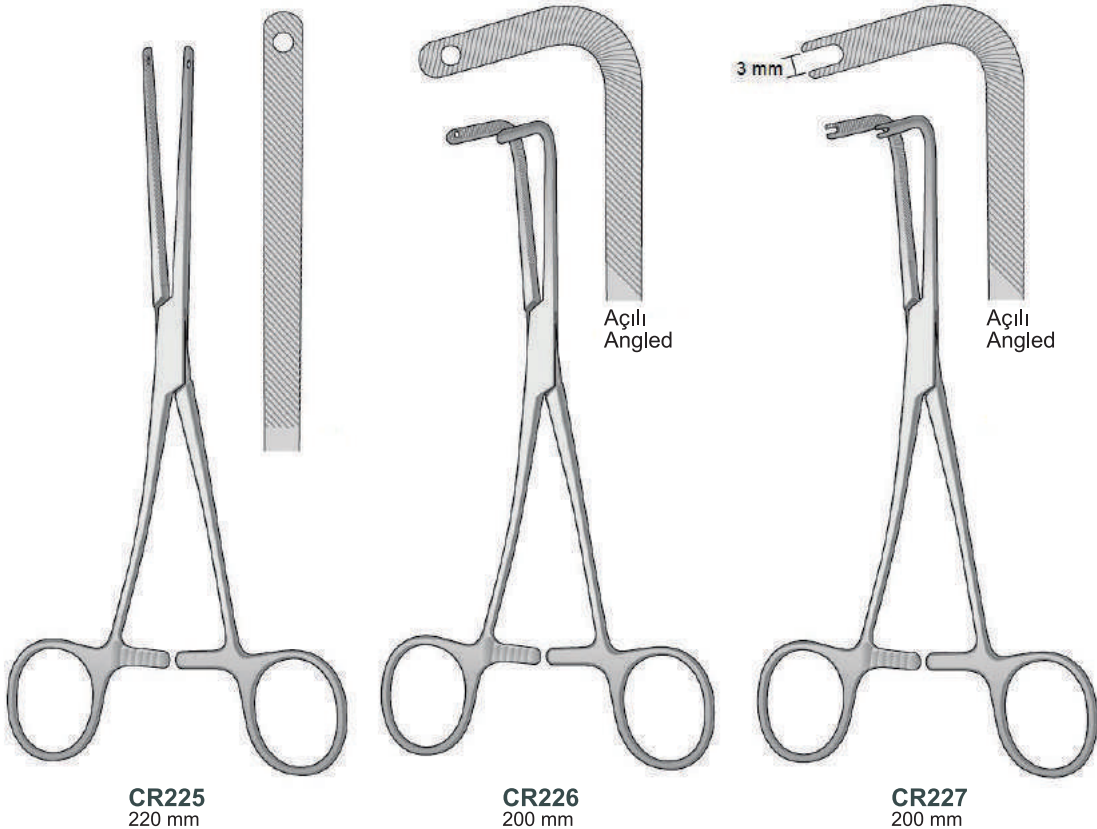


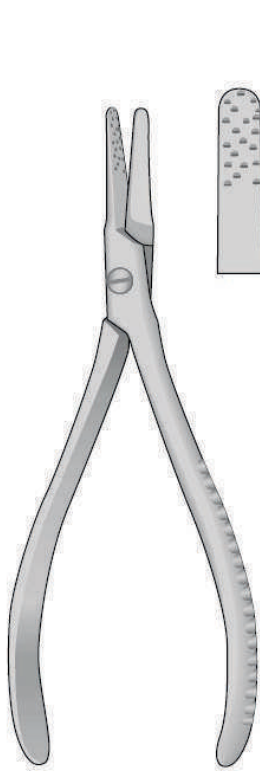
CR224

Implantoloji Kalibre Üç Boyutlu
Implantology Calliper Tridimensional

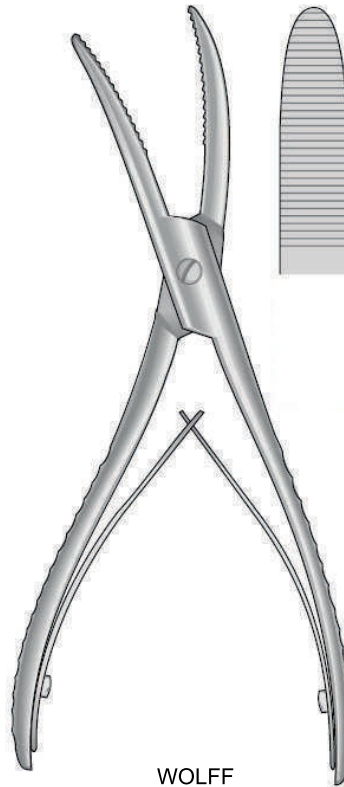


Kemik Tutma Kelepçeleri
Bone Holding Clamps

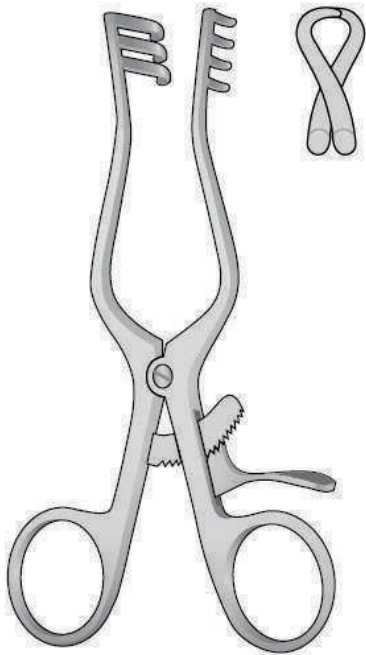




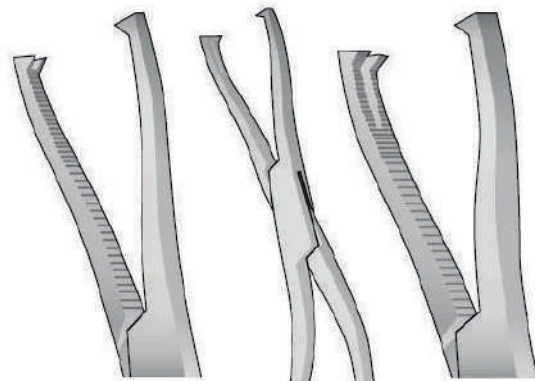
**RADOLF
CR228**
135 mm



**WOLFF
CR229**
180 mm

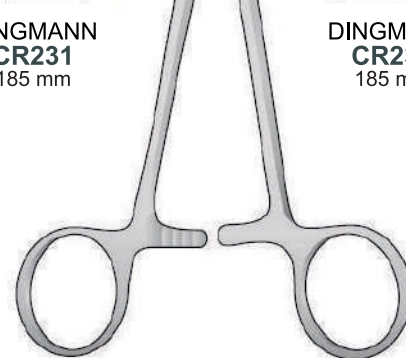


**WEITLANER
CR230**
165 mm

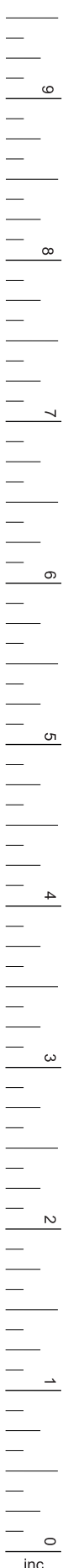


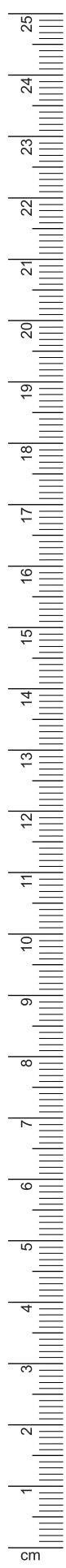
**DINGMANN
CR231**
185 mm

**DINGMANN
CR232**
185 mm



DINGMANN
185 mm





CR233
100 mm



CR234
130 mm



CR235
150 mm



CR236⁴
150 mm



CR237



CR238³
145 mm



CR239



CR240



CR241⁵



CR242^{5A}

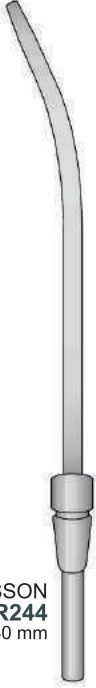


CR243
155 mm



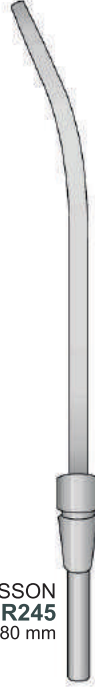
ASPIRATÖR UÇLARI

Ø 2.0 mm



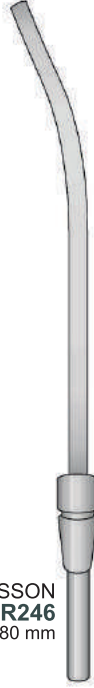
**MC. KESSON
CR244
180 mm**

Ø 3.0 mm



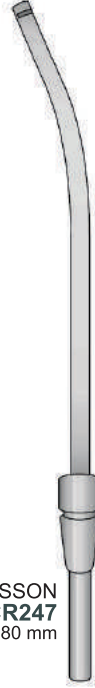
**MC. KESSON
CR245
180 mm**

Ø 4.0 mm

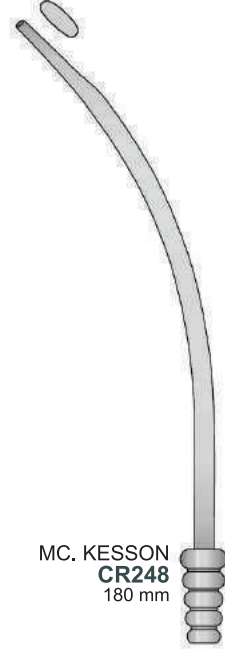


**MC. KESSON
CR246
180 mm**

Ø 4.0 mm



**MC. KESSON
CR247
180 mm**



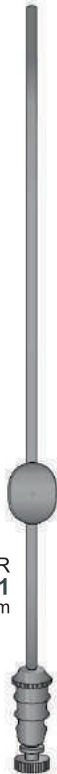
**MC. KESSON
CR248
180 mm**



**YANKAUER
CR249
310 mm**



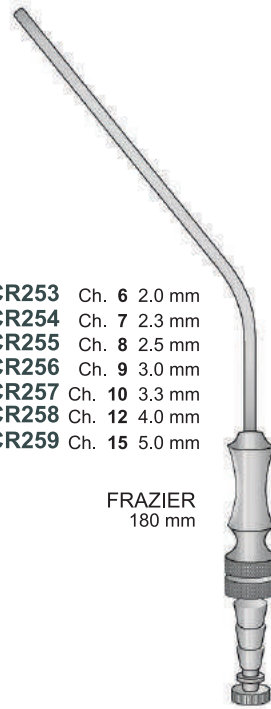
**YANKAUER
CR250
310 mm**



**YANKAUER
CR251
310 mm**

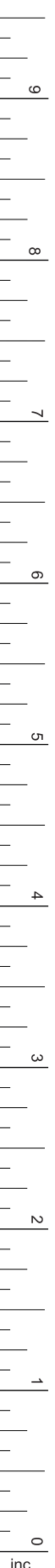


**YANKAUER
CR252
310 mm**

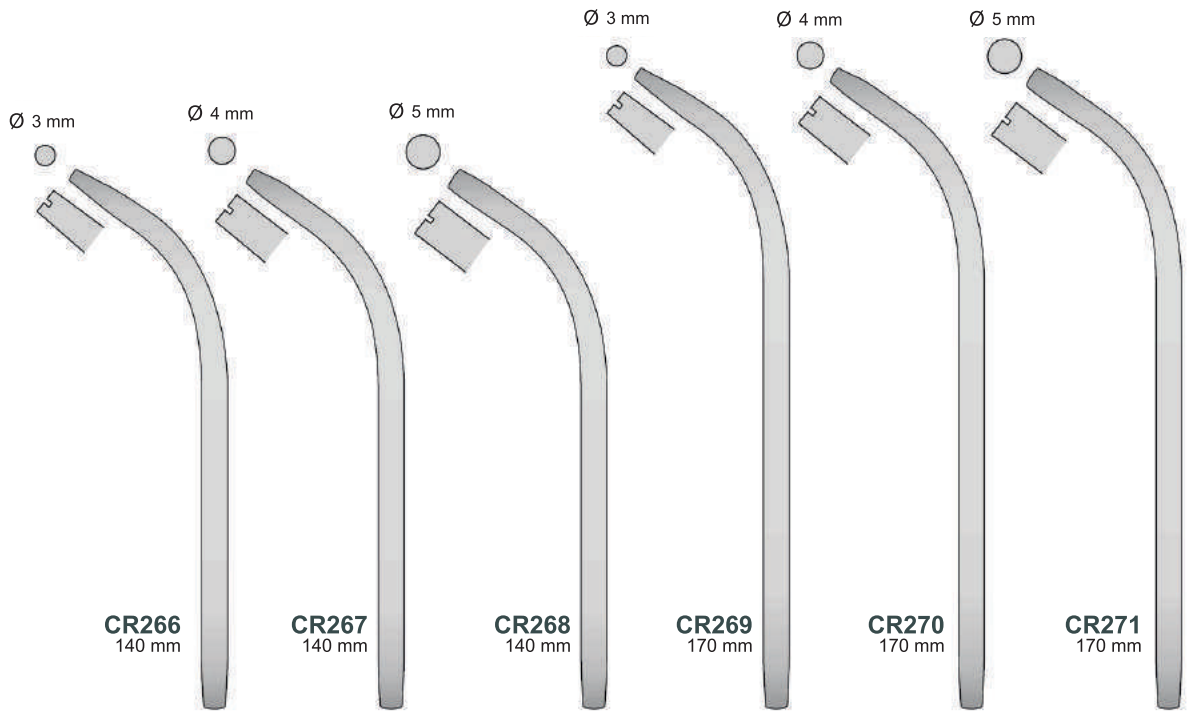
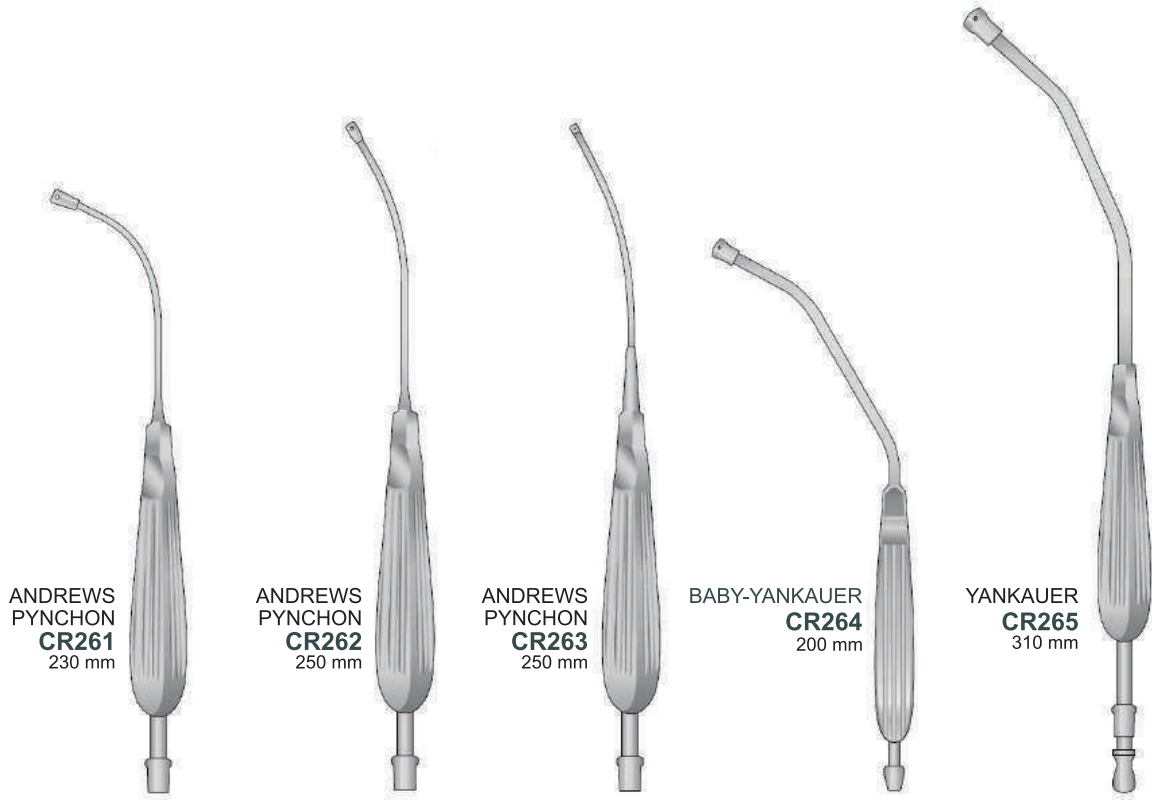


- CR253** Ch. 6 2.0 mm
- CR254** Ch. 7 2.3 mm
- CR255** Ch. 8 2.5 mm
- CR256** Ch. 9 3.0 mm
- CR257** Ch. 10 3.3 mm
- CR258** Ch. 12 4.0 mm
- CR259** Ch. 15 5.0 mm

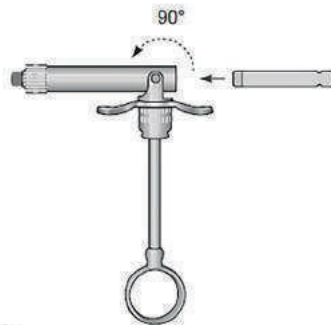
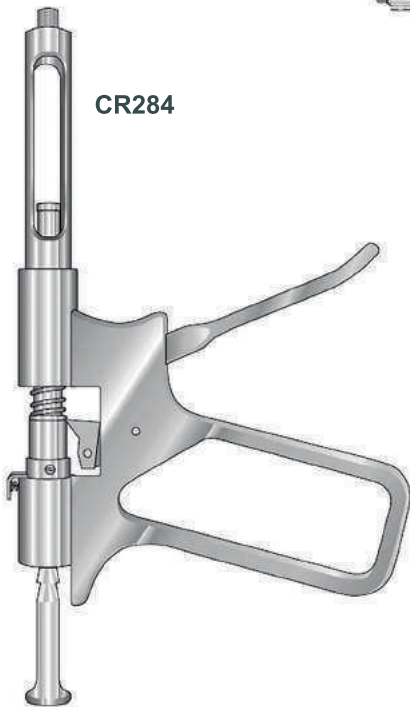
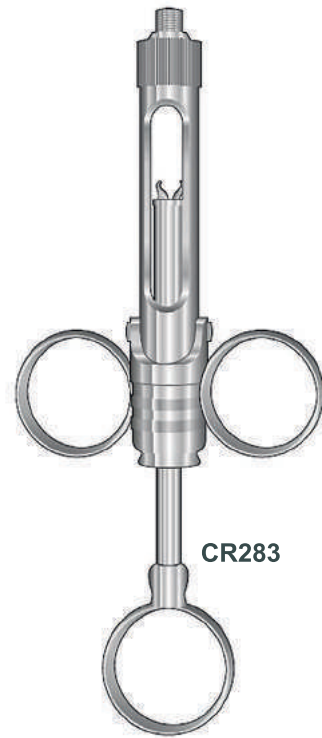
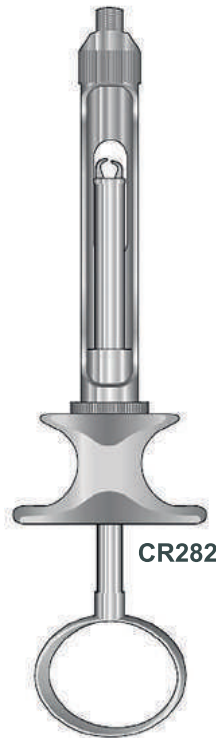
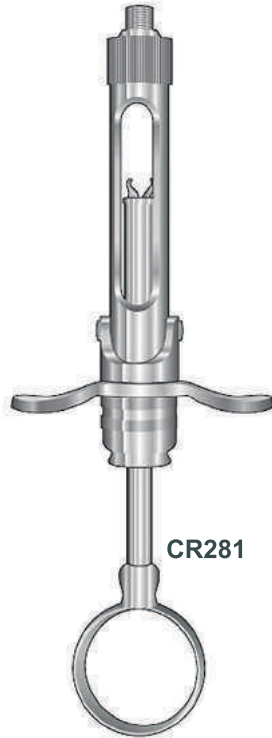
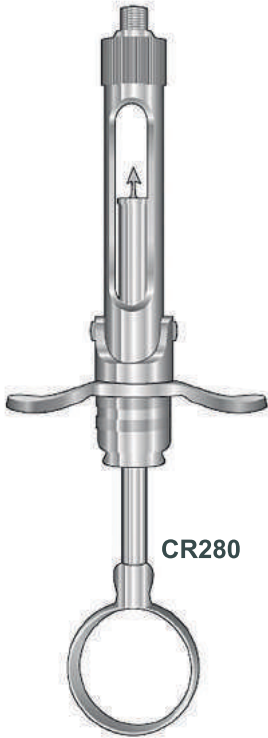
**FRAZIER
180 mm**



ASPIRATÖR UÇLARI

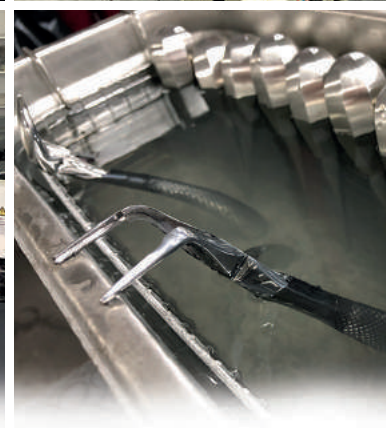
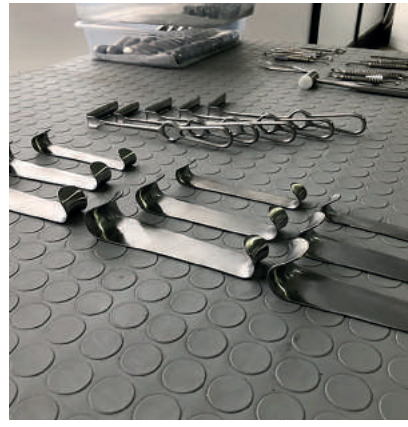
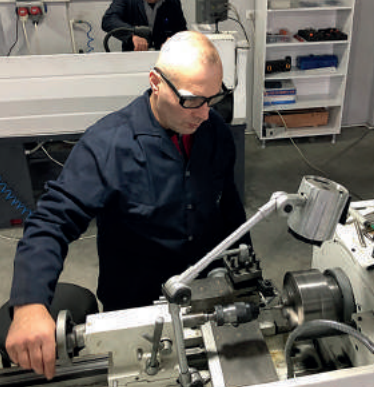


KARPÜL TABANCASI



110 mm







ÇENE CERRAHİSİ
MAXILLOFACIAL SURGERY





ADAMS
MS001
500 mm



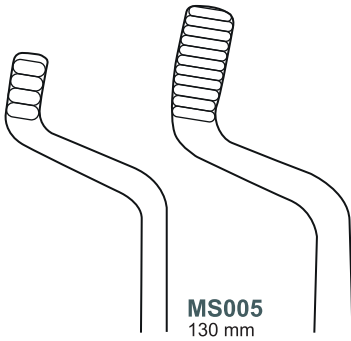
LANGENBECK
MS002
Ø 26 / 20 mm



MAUNDER
MS003
95 mm



PİTHA
MS004
28x30 mm



MS005
130 mm

MS006
130 mm



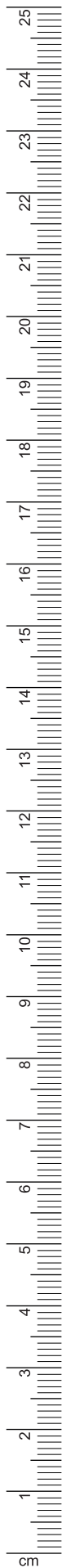
ROSER-KÖNIG
130 mm

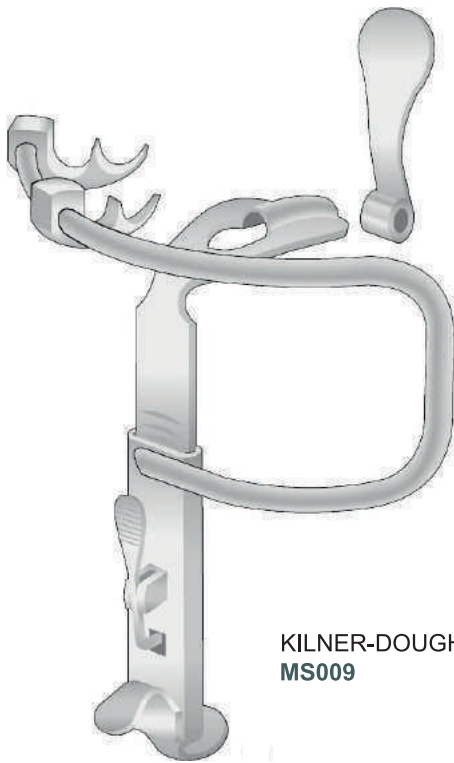


HEİSTER
MS007
130 mm



DENHARDT
MS008
130 mm





**KILNER-DOUGHTY
MS009**



**Fig.1
MS010
68x30 mm**



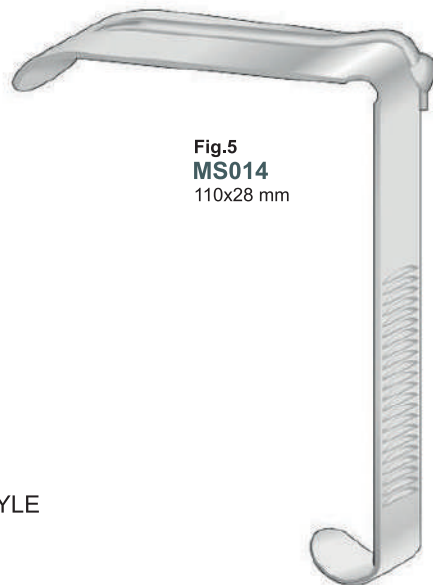
**Fig.2
MS011
77x34 mm**



**Fig.3
MS012
82x39 mm**



**DAVIS-BOYLE
MS013**



**Fig.5
MS014
110x28 mm**



**Fig.4
MS015
95x27 mm**



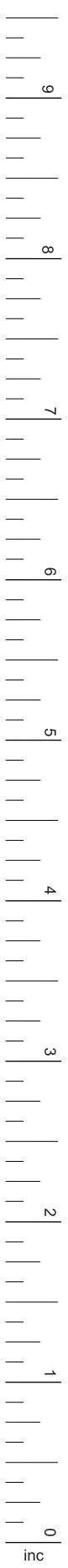
**Fig.3
MS016
80x27 mm**

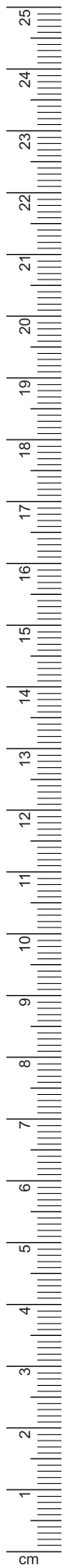


**Fig.2
MS017
65x26 mm**



**Fig.1
MS018
30x20 mm**





McLVOR
MS019



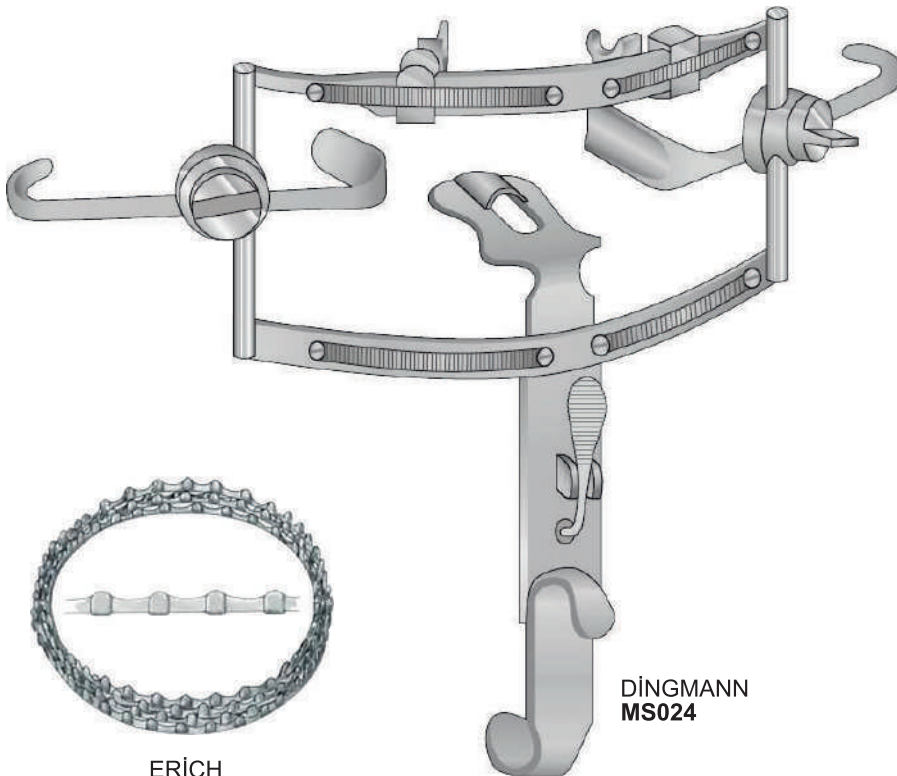
Fig.3
MS020
100x25 mm



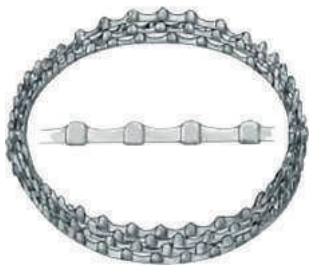
Fig.2
MS021
85x25 mm



Fig.1
MS022
75x25 mm



DINGMANN
MS024



ERICH
MS023

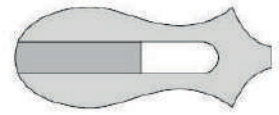


Fig.1
MS025
62x26 mm

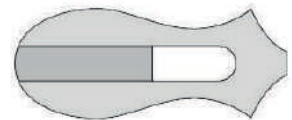


Fig.2
MS026
65x30 mm

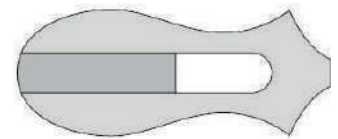


Fig.3
MS027
78x32 mm



MARTIN-SIMPLEX
MS028
105 mm



CAWOOD
MINNESOTA
MS029
145 mm



MS030
19 mm
150 mm
Wood



MS031
15 mm
150 mm



DOYEN



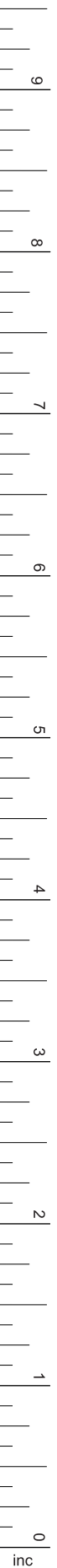
MS032
23x30 mm
130 mm

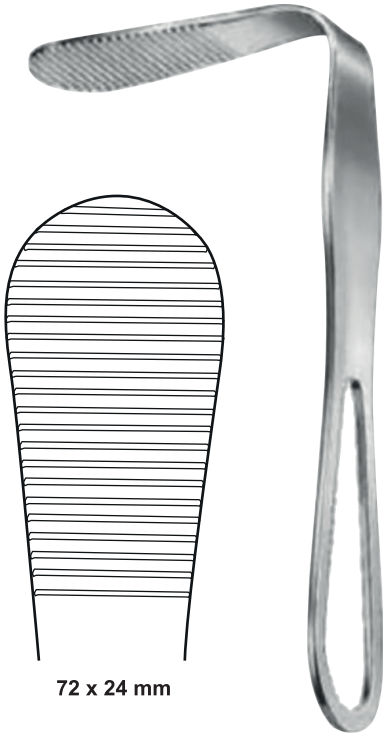
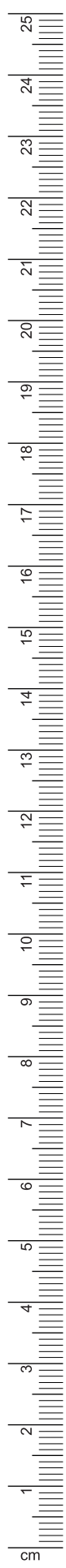


MS033
30x33 mm
160 mm

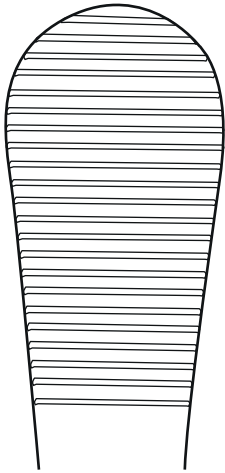


OBWEGESER
MS034
12 mm

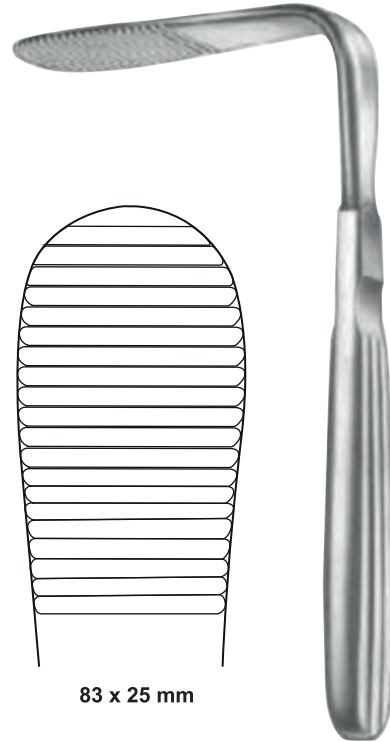




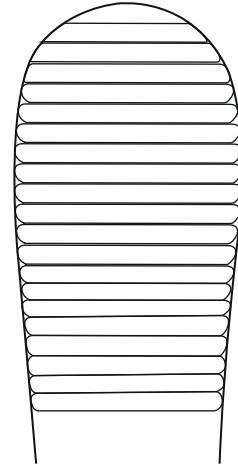
HARTMANN
MS035
150 mm



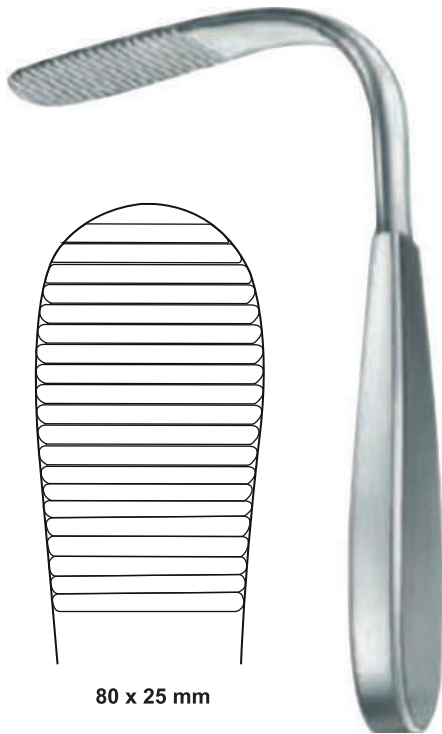
72 x 24 mm



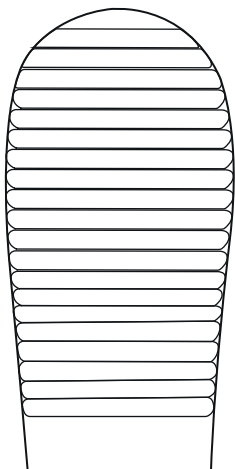
TOBOLD
MS036
150 mm



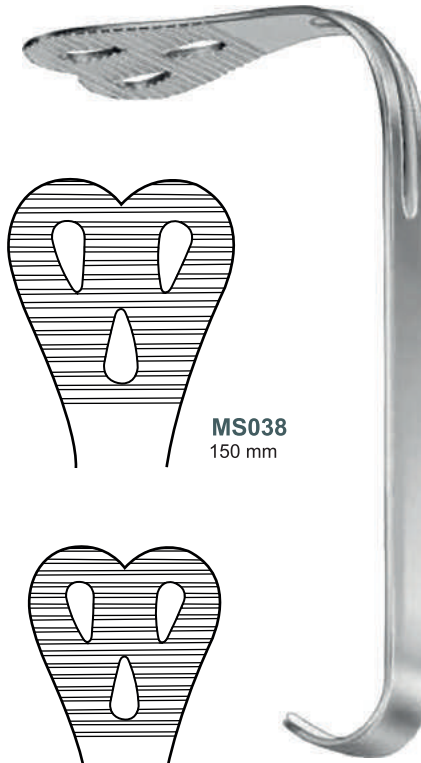
83 x 25 mm



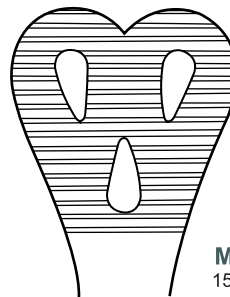
TOBOLD
MS037
160 mm



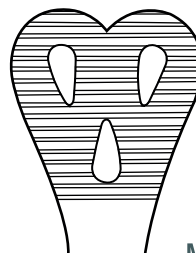
80 x 25 mm



WIEDER
150 mm



MS038
150 mm



MS039
140 mm



MS040
230 mm

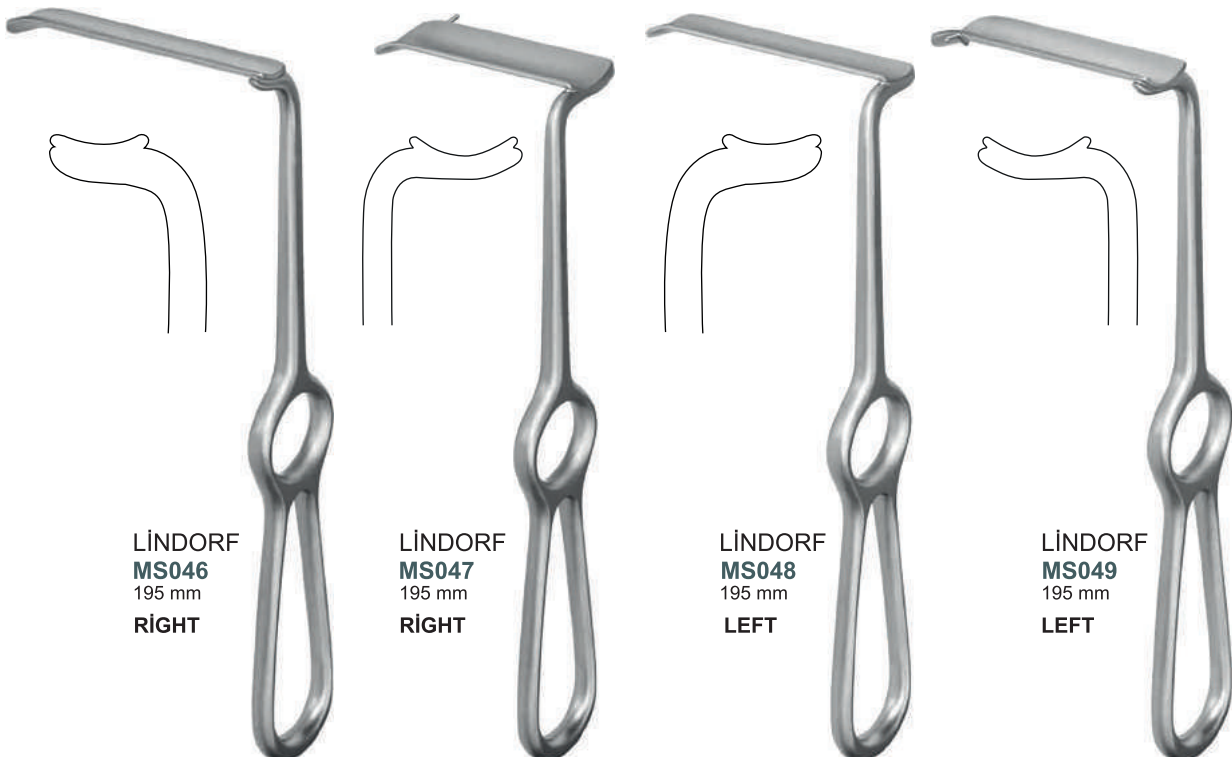
MS041
210 mm

MS042
210 mm

MS043
250 mm

**ECKELT
MS044**
210 mm

**ECKELT
MS045**
210 mm

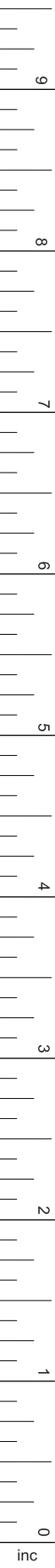


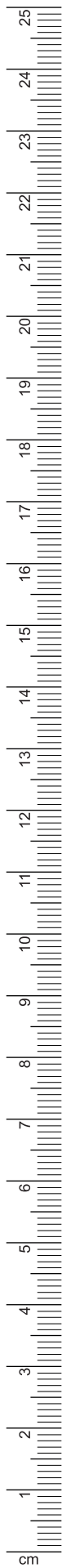
**LINDORF
MS046**
195 mm
RIGHT

**LINDORF
MS047**
195 mm
RIGHT

**LINDORF
MS048**
195 mm
LEFT

**LINDORF
MS049**
195 mm
LEFT





**SCHUCHARDT
MS050**
180 mm

**METZ
MS051**
195 mm

**SCHUCHARDT
MS052**
180 mm

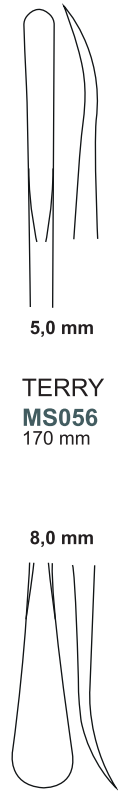
**METZ LAUER
MS053**
195 mm



**TERRY
MS054**
115 mm



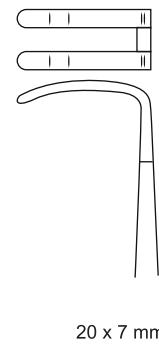
**TERRY
MS055**
130 mm



**TERRY
MS056**
170 mm



**KOBERG
MS057**
180 mm
15 x 7 mm



20 x 7 mm



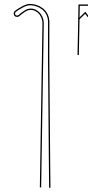
OBWEGESER



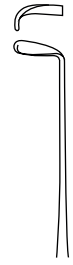
MS058
175 mm
Periost Elevatör
Periosteal Elevator



MS059
175 mm
Periost Elevatör
Periosteal Elevator



MS060

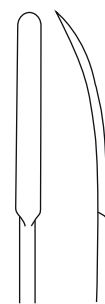


MS061



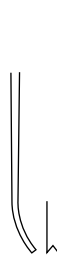
3 mm

MS062
180 mm



3,5 mm

MS063
180 mm



OBWEGESER



MS064
6 mm
175 mm



MS065
7 mm
175 mm



MS066
9 mm
175 mm



MS067
11 mm
175 mm



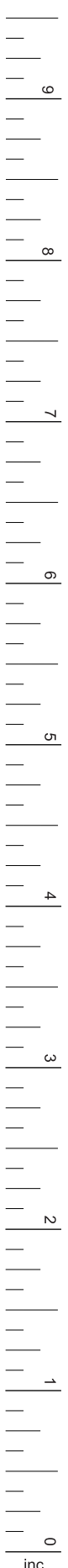
MS068
5 mm
200 mm



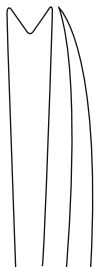
MS069
7 mm
200 mm



MS070
9 mm
200 mm



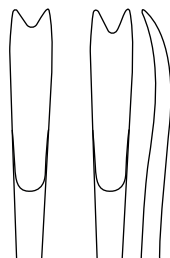
OBWEGESER



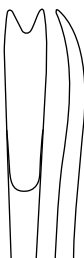
MS071
7,5 mm
175 mm



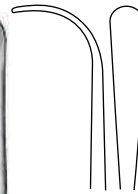
MS072
11 mm
175 mm



MS073
175 mm



MS074
175 mm

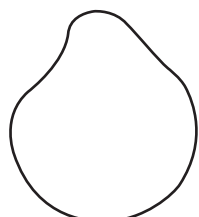


MS075
205 mm

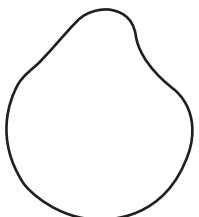


MS076
205 mm

ROWE
190 mm



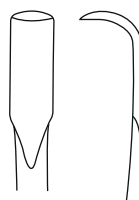
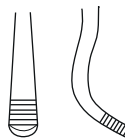
MS077
RIGHT



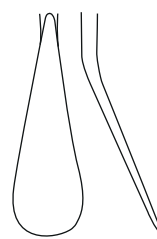
MS078
LEFT



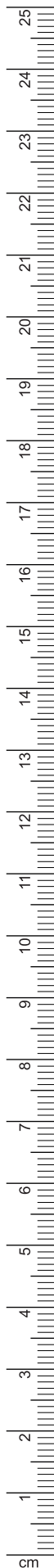
MS079
170 mm

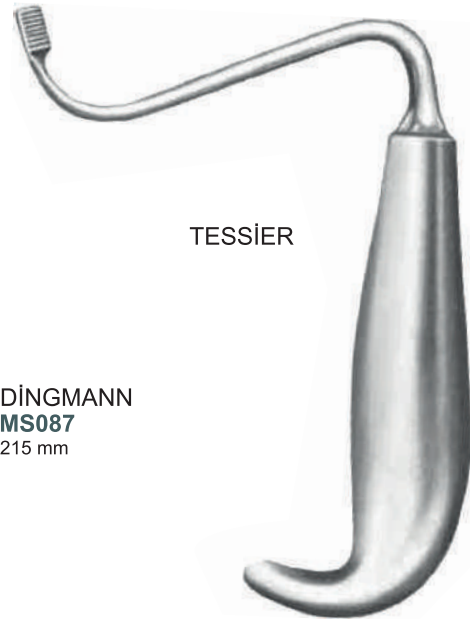
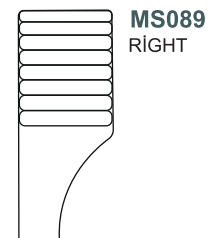
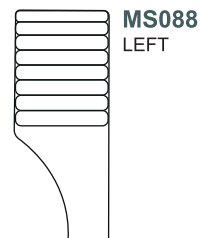
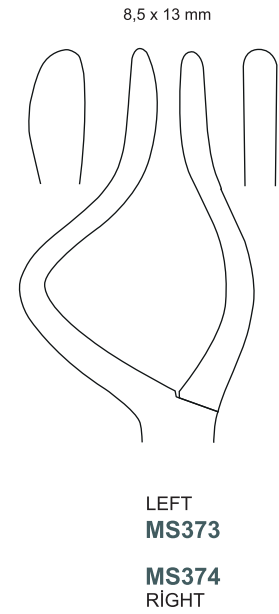
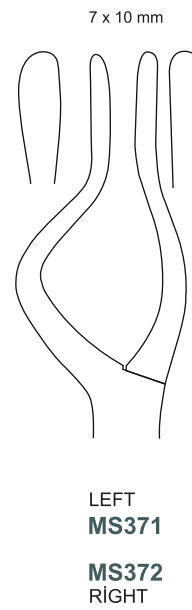
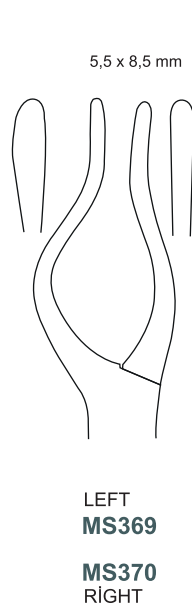
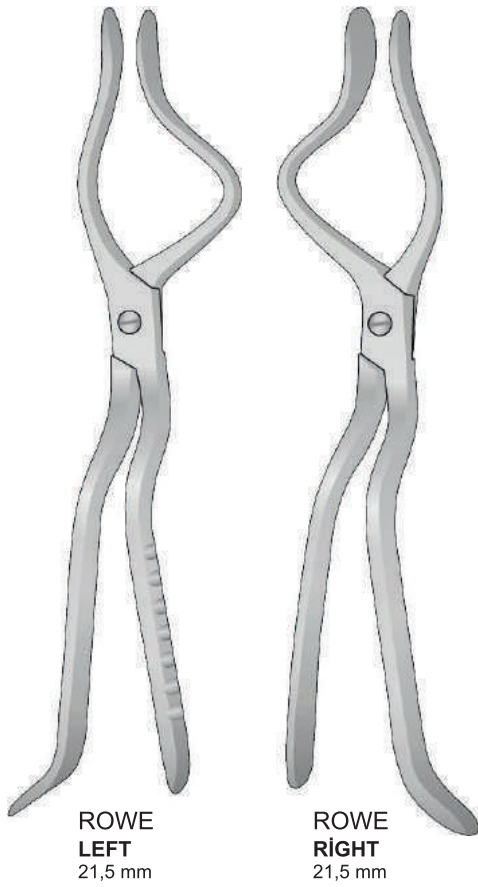


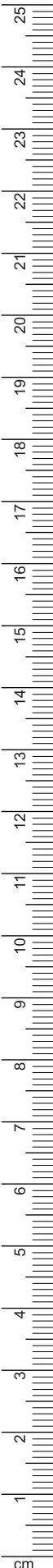
DONOVAN
MS080
190 mm
16,5 mm



ROWE
MS081
150 mm



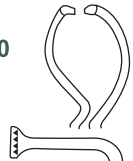




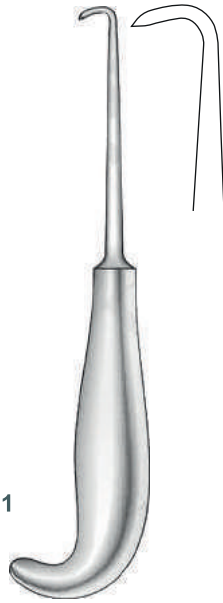
KEEN
175 mm



MS090
RIGHT



MS091
LEFT



DINGMANN-WILK
MS092
200 mm



TROCAR and DRILL GUIDE
MS093



STEINHAUSER
MS094
125 mm



STEINHAUSER
MS095
135 mm



WOLFORD
MS096
250 mm

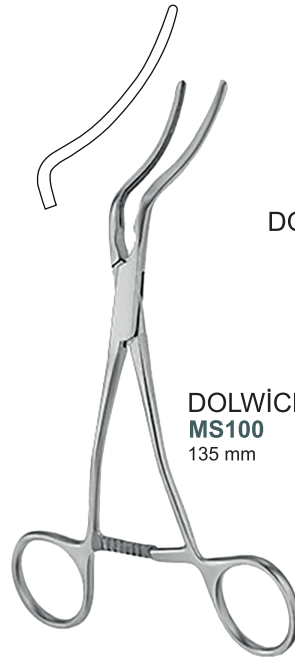


**SALYER
MS097**
165 mm



**LEFT
DOLWICK
MS098**
160 mm

**RIGHT
DOLWICK
MS099**
160 mm



**DOLWICK
MS100**
135 mm



**DOLWICK
MS101**
145 mm



**DOLWICK
MS102**
135 mm



**DOLWICK
MS103**
170 mm



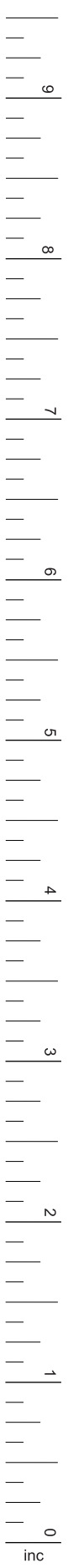
**DOLWICK
MS104**
175 mm

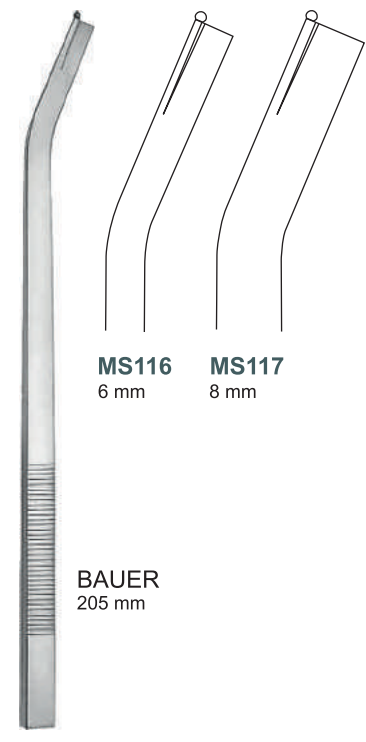
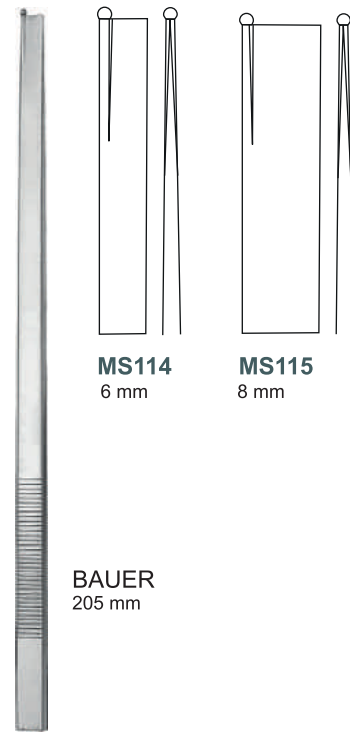
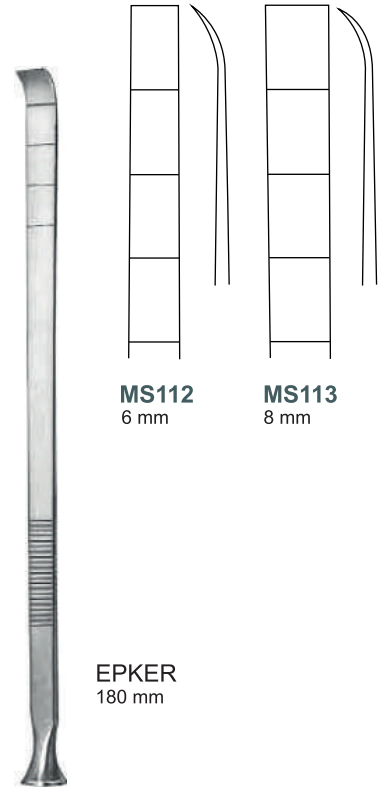
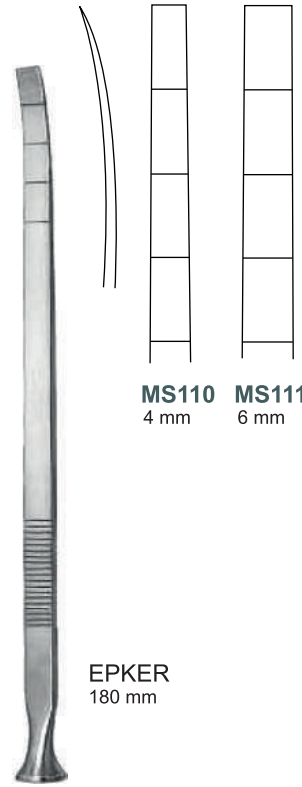
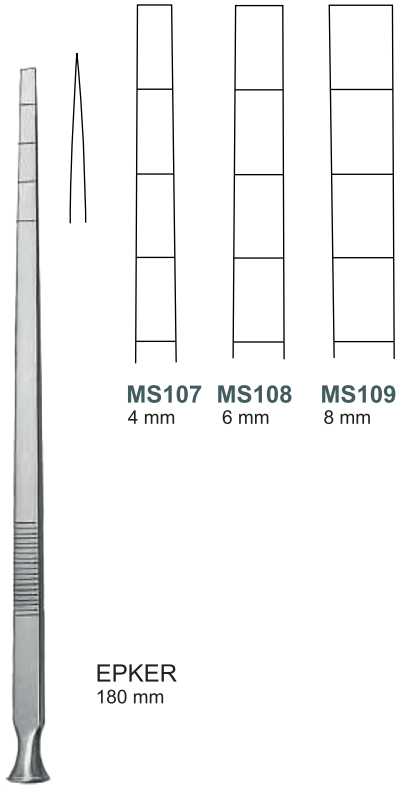
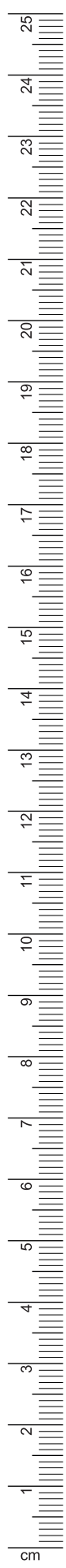


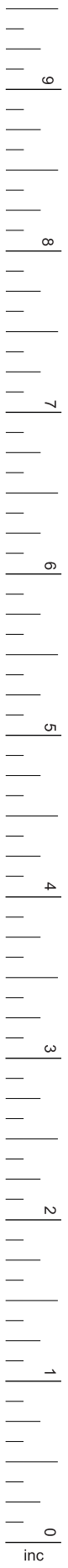
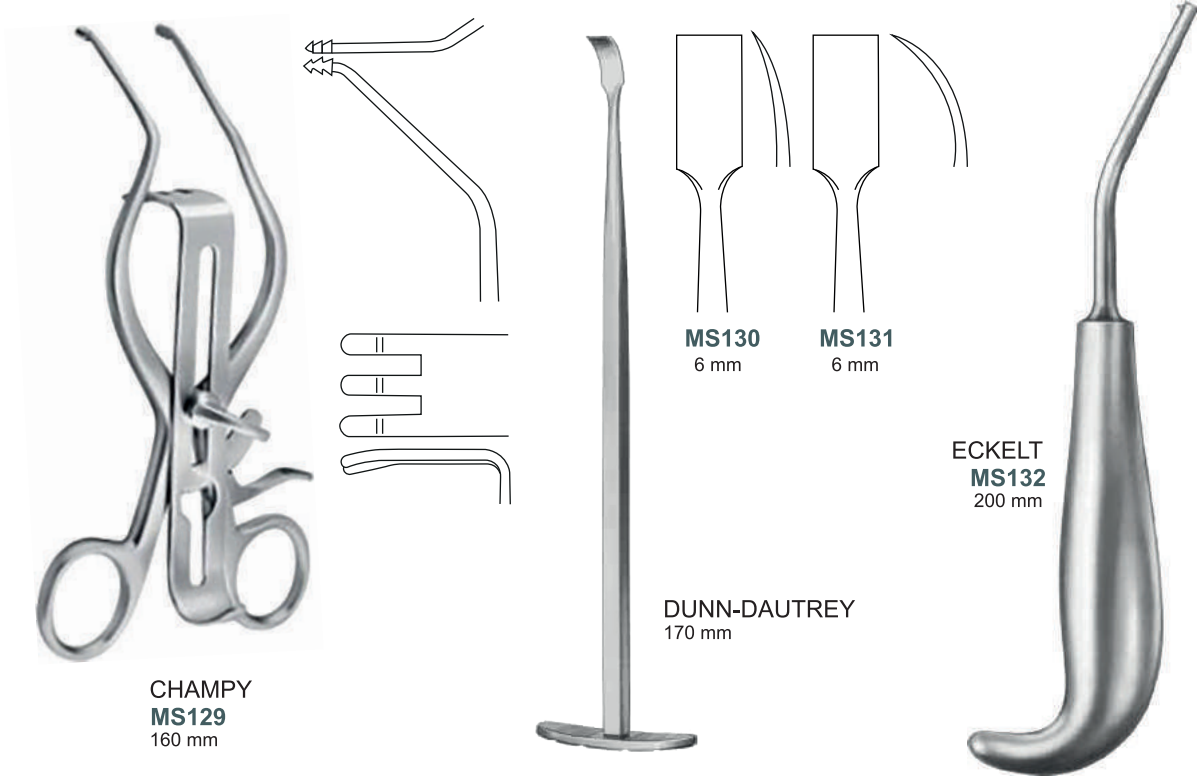
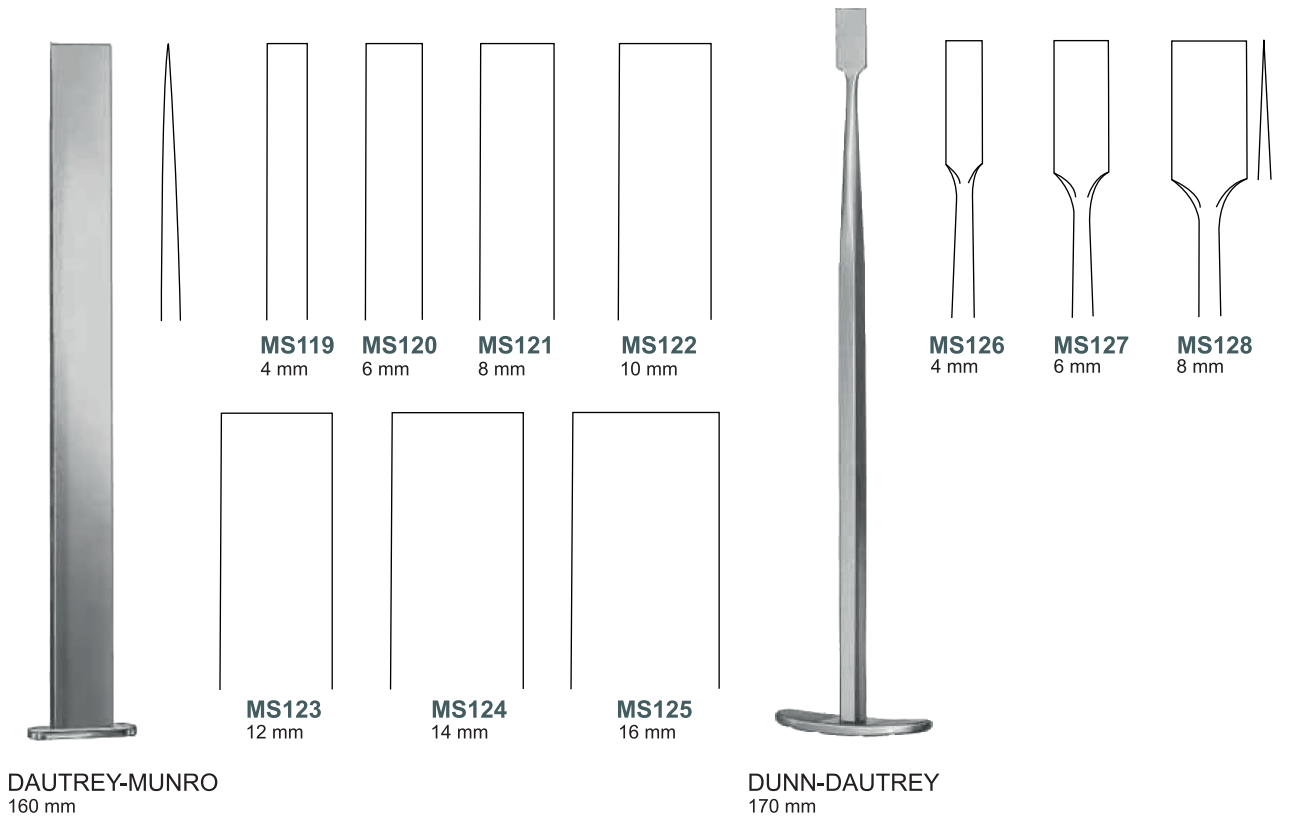
**DOLWICK
MS105**
150 mm

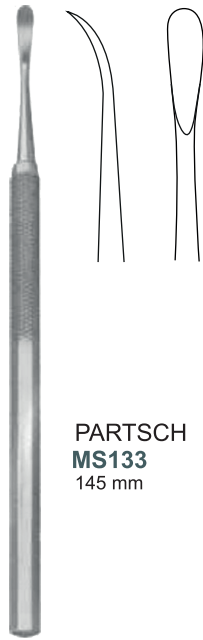
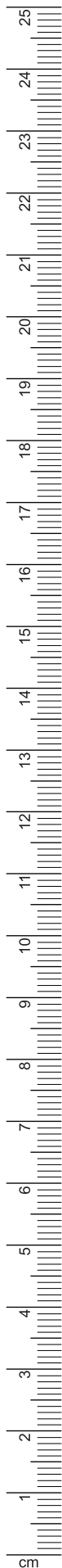


**DOLWICK
MS106**
150 mm









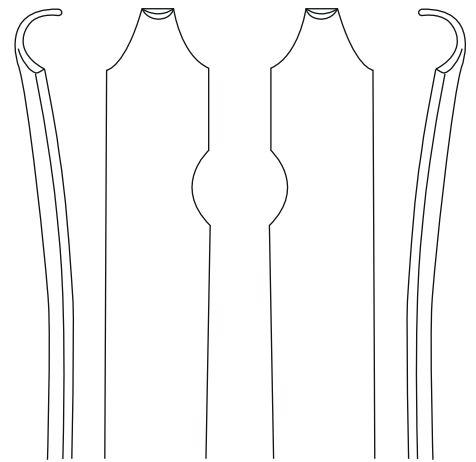
**PARSCH
MS133**
145 mm



**HARGİS
MS134**
160 mm

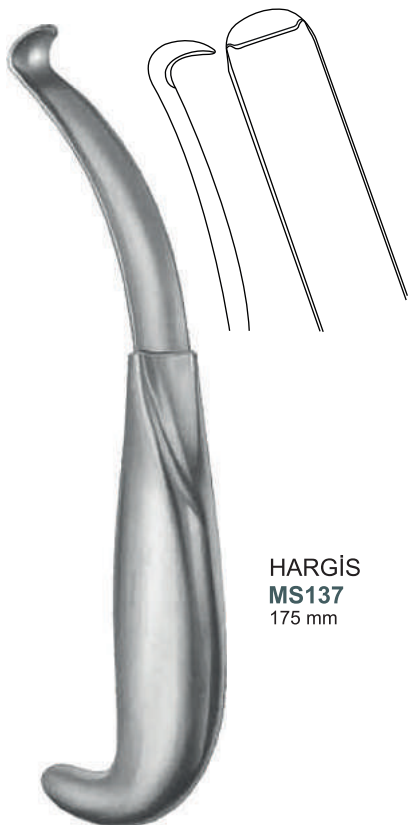


HARGİS
195 mm



**LEFT
MS135**

**RIGHT
MS136**



**HARGİS
MS137**
175 mm



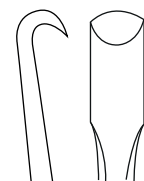
HARGİS
175 mm



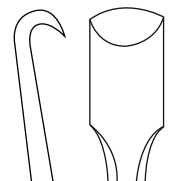
MS138
6,5 mm



MS139
9 mm



MS140
6,5 mm



MS141
9 mm



HARGİS
MS142
185 mm



HARGİS
MS143
185 mm



HARGİS
MS144
220 mm



HARGİS
MS145
220 mm



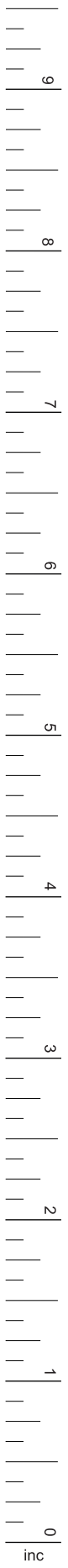
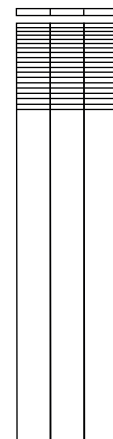
SMİTH
RIGHT
MS146
185 mm

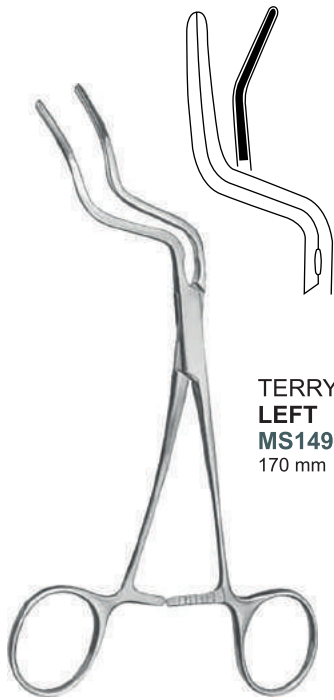
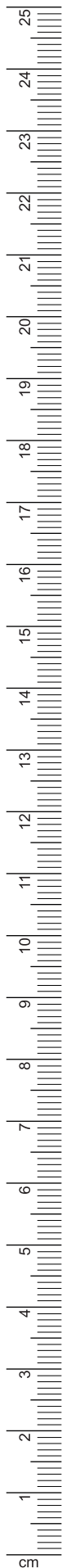


SMİTH
LEFT
MS147
185 mm

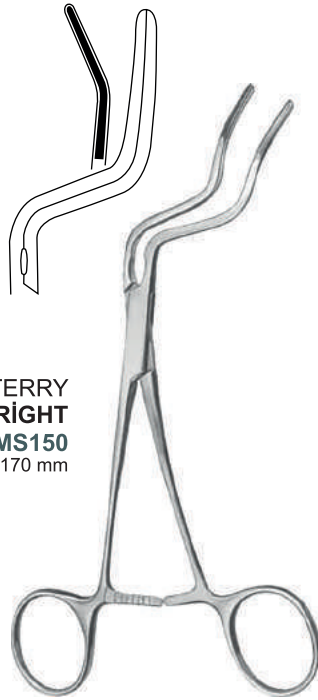


SMİTH
MS148
235 mm





**TERRY
LEFT
MS149**
170 mm



**TERRY
RIGHT
MS150**
170 mm



**TERRY
MS151**
165 mm



**TERRY
MS152**
240 mm

Ø 2,5 mm



**TERRY
MS153**
170 mm



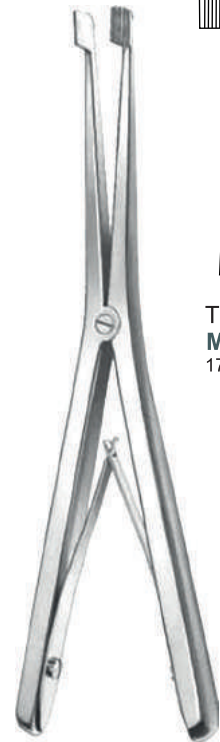
**TERRY
MS154**
190 mm



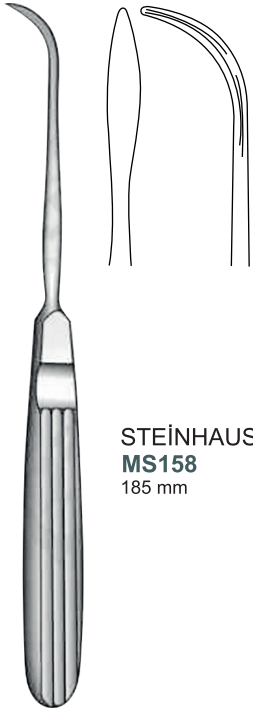
**RIGHT
TERRY
MS155**
140 mm



**LEFT
TERRY
MS156**
140 mm



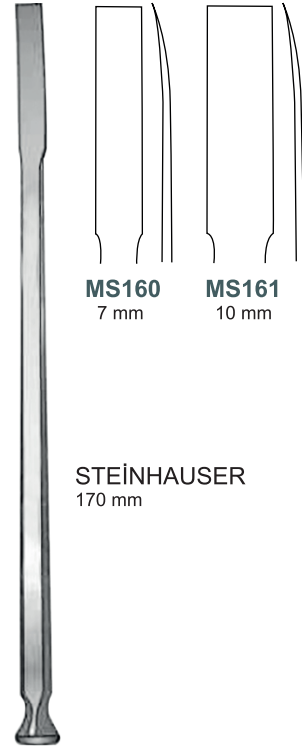
**TURVEY
MS157**
170 mm



STEINHAUSER
MS158
185 mm



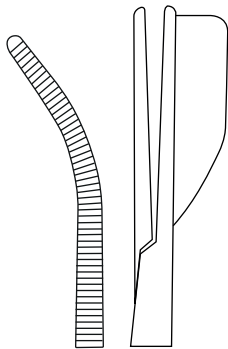
STEINHAUSER
MS159
270 mm



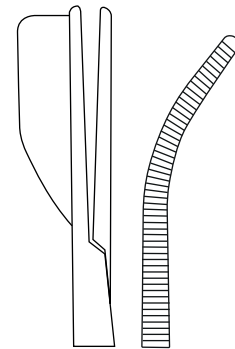
MS160
7 mm

MS161
10 mm

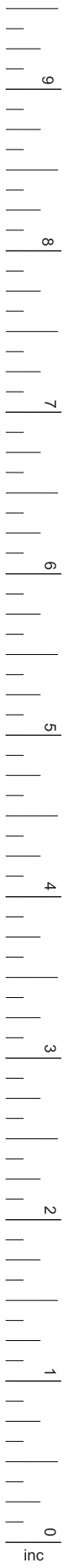
STEINHAUSER
170 mm

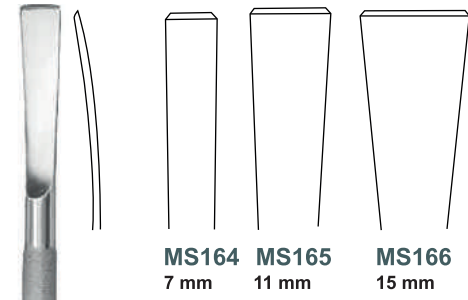
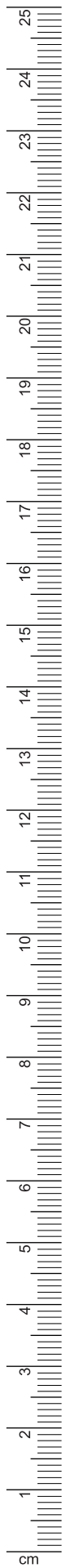


STEINHAUSER
RIGHT
MS162
160 mm



STEINHAUSER
LEFT
MS163
160 mm



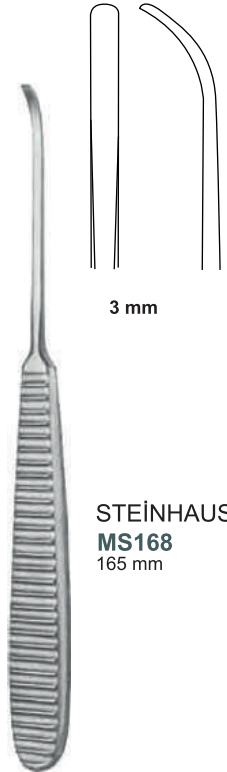


MS164 7 mm
MS165 11 mm
MS166 15 mm

STEINHAUSER
190 mm

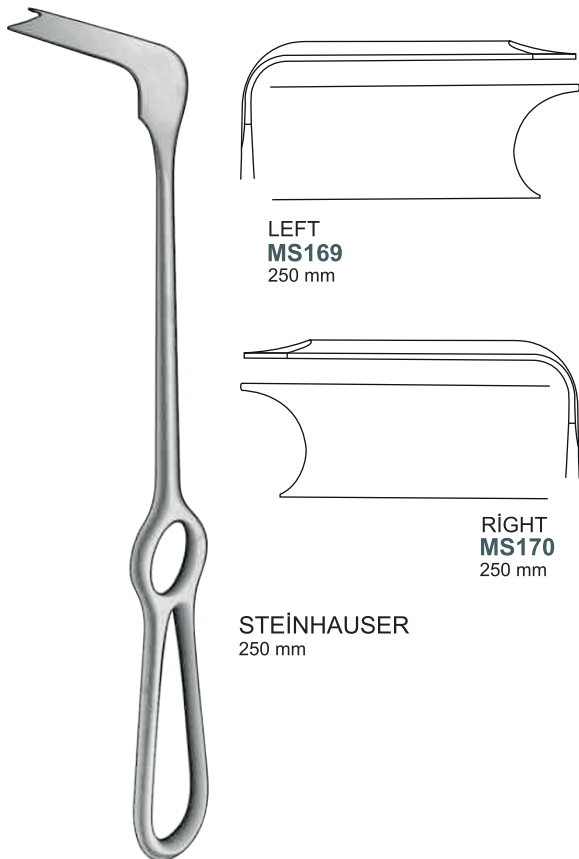


STEINHAUSER
MS167
180 mm



3 mm

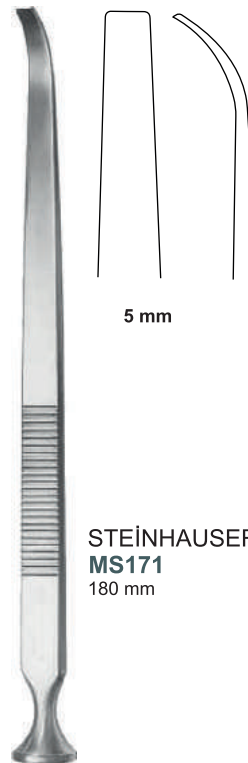
STEINHAUSER
MS168
165 mm



LEFT
MS169
250 mm

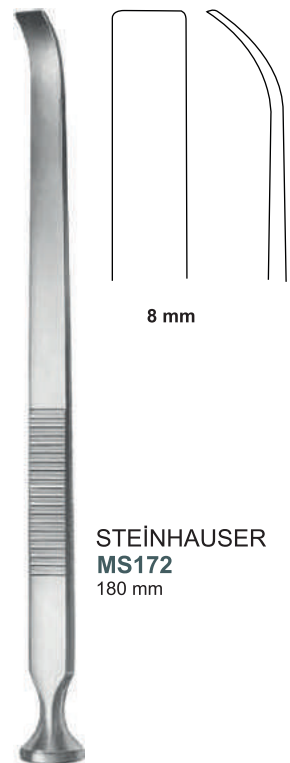
RIGHT
MS170
250 mm

STEINHAUSER
250 mm



5 mm

STEINHAUSER
MS171
180 mm

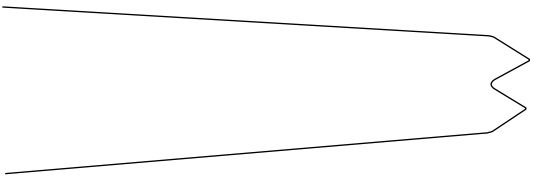


8 mm

STEINHAUSER
MS172
180 mm



MS173
75 x 11/15 mm



MS174
75 x 12/22 mm



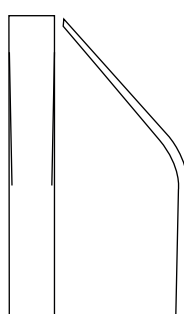
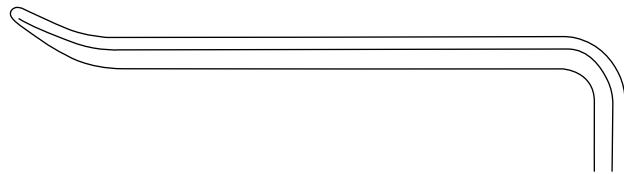
MS175
30 x 9/12 mm



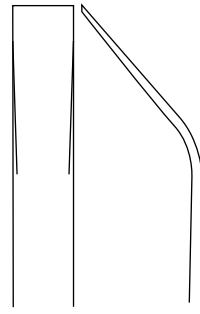
MS176
45 x 9/12 mm



MS177
60 x 9/12 mm



MS178
6 mm



MS179
8 mm



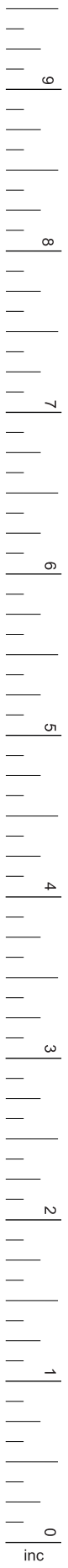
OBWEGESER
240 mm

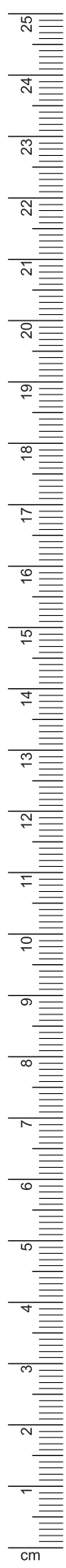


WOLFORD
215 mm



OBWEGESER
240 mm





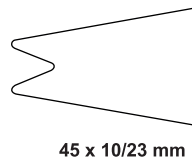
RIGHT
OBWEGESER
MS180
165 mm

OBWEGESER
MS181
170 mm

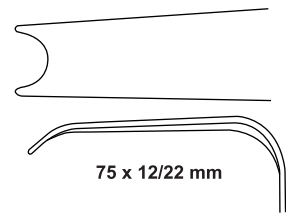


LEFT
OBWEGESER
MS182
165 mm

OBWEGESER
MS183
170 mm



45 x 10/23 mm



75 x 12/22 mm



OBWEGESER
180 mm



MS184
6 mm



MS185
7 mm



MS186
9 mm



MS187
11 mm



OBWEGESER
MS188
240 mm



OBWEGESER
MS189
240 mm



LEFT
OBWEGESER
MS190
180 mm



RIGHT
OBWEGESER
MS191
180 mm



MS192
5 mm



MS193
7 mm



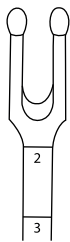
MS194
9 mm



OBWEGESER
210 mm



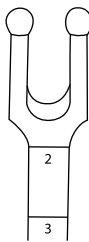
OBWEGESER
190 mm



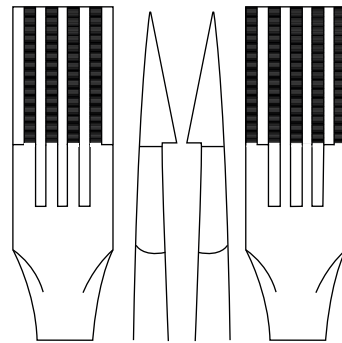
MS195
4 mm



MS196
6 mm



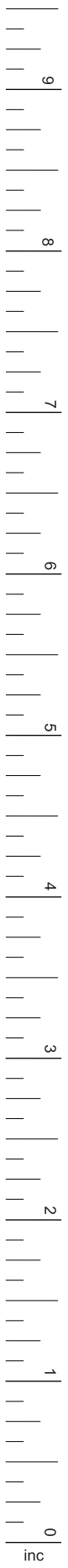
MS197
8 mm

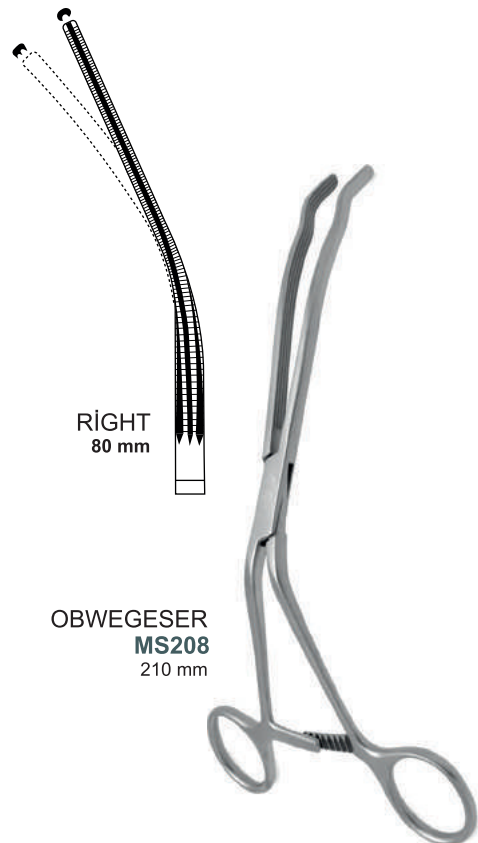
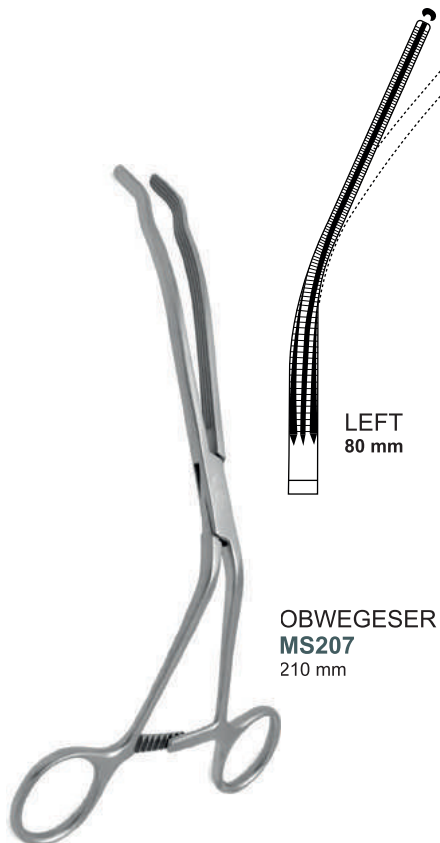
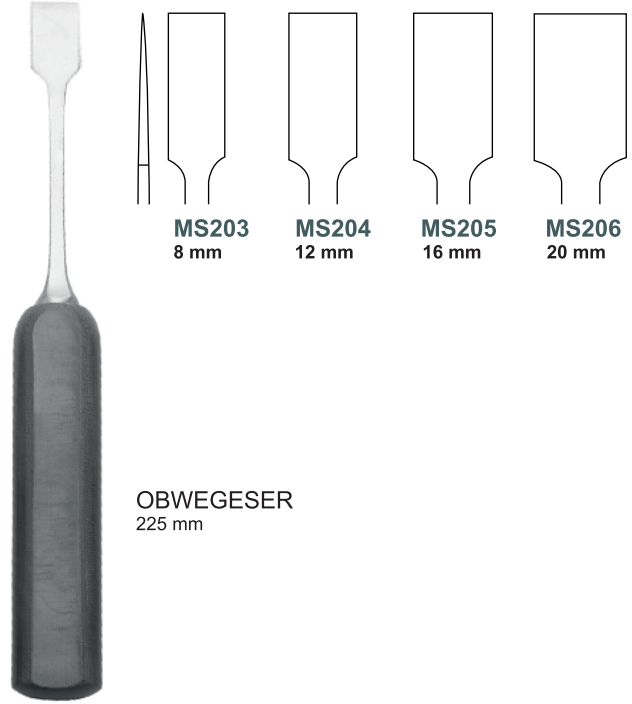
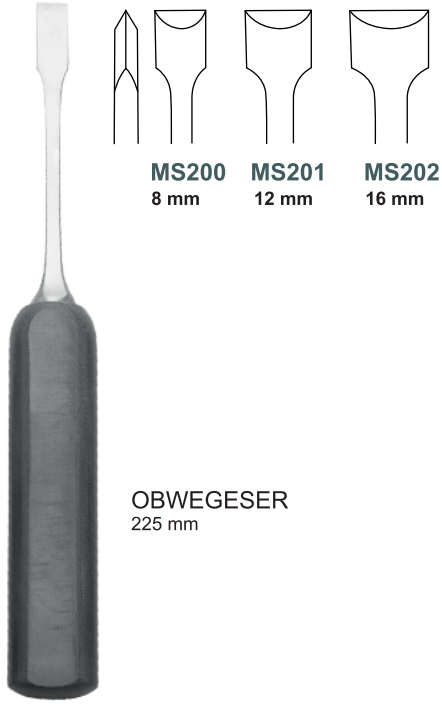
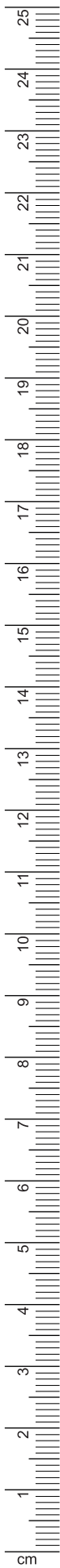


MS198
15 mm

MS199
20 mm

OBWEGESER
220 mm

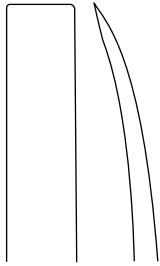




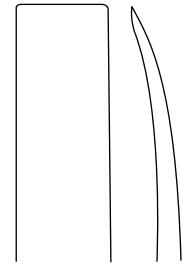


MS209
8 mm

OBWEGESER
230 mm



MS210
11 mm



MS211
8 mm

OBWEGESER
210 mm

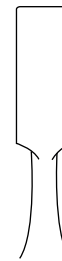
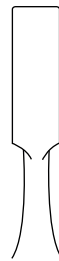
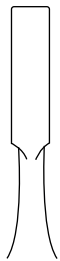


MS212
11 mm



MS213
3 mm

OBWEGESER
150 mm

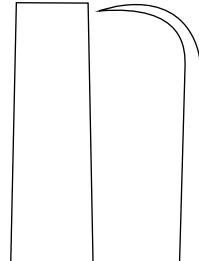


MS214
4 mm

MS215
6,5 mm



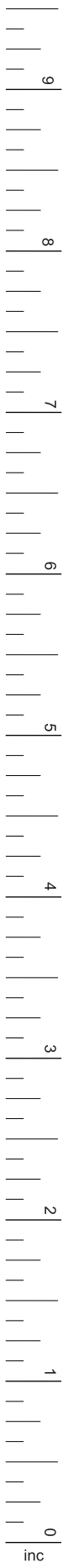
OBWEGESER
MS216
230 mm

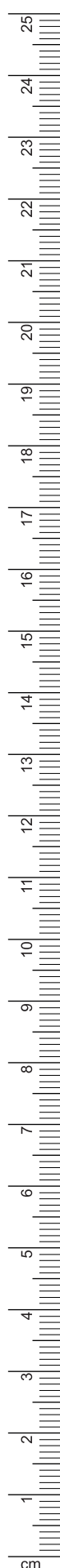


12 mm



OBWEGESER
MS217
240 mm





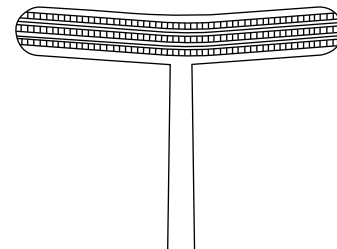
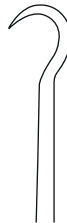
**OBWEGESER
MS218**
175 mm



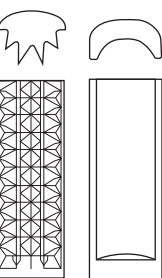
**OBWEGESER
MS219**
150 mm



**TESSIER
MS220**
190 mm

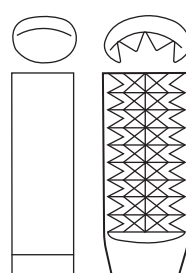


**TESSIER
MS221**
190 mm



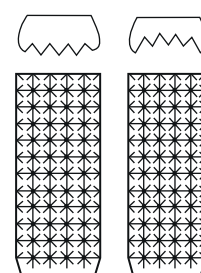
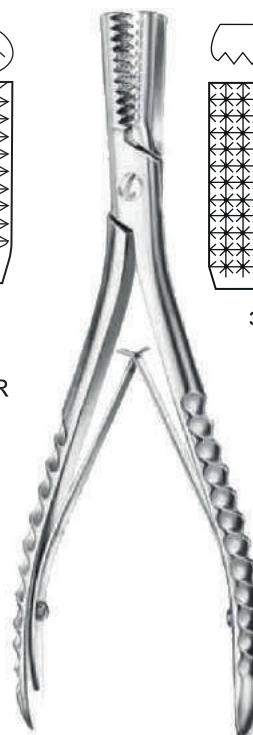
30 x 12 mm

**OBWEGESER
MS222**
180 mm



30 x 13,5 mm

**OBWEGESER
MS223**
180 mm



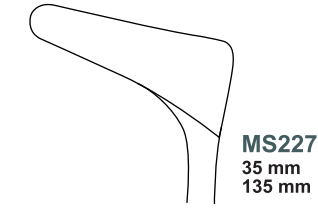
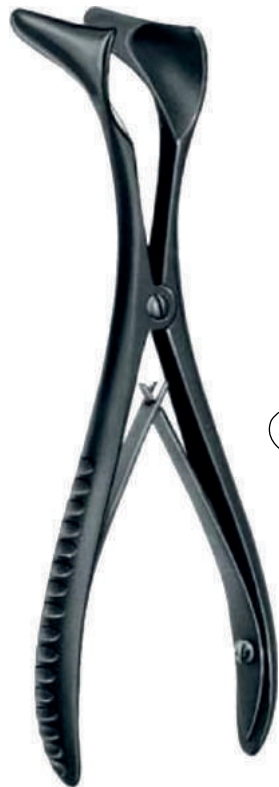
30 x 13,5 mm

**OBWEGESER
MS224**
180 mm

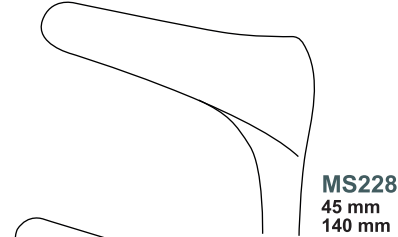


MS225 **MS226**

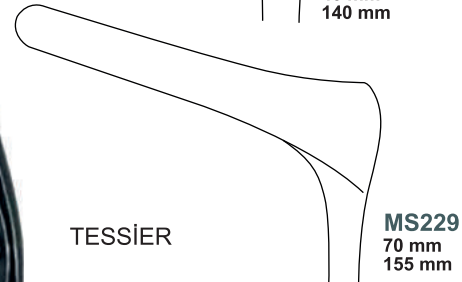
OBWEGESER
140 mm



MS227
35 mm
135 mm



MS228
45 mm
140 mm

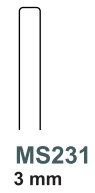


TESSIER

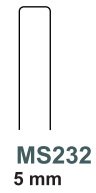
MS229
70 mm
155 mm



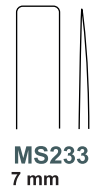
MS230
2 mm



MS231
3 mm



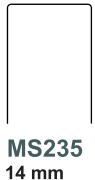
MS232
5 mm



MS233
7 mm



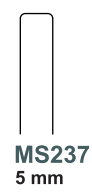
MS234
10 mm



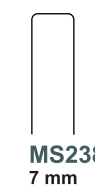
MS235
14 mm



MS236
16 mm



MS237
5 mm

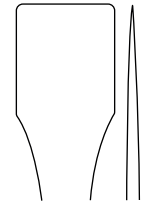


MS238
7 mm



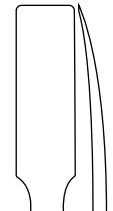
MS239
10 mm

TESSIER
160 mm



18 mm

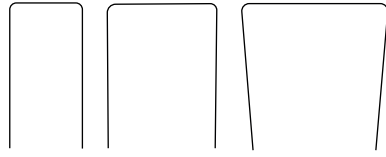
TESSIER
MS240
160 mm



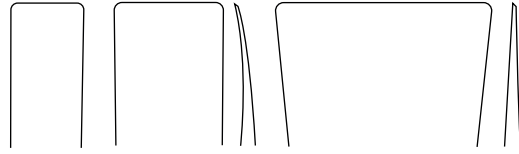
10 mm

TESSIER
MS241
180 mm



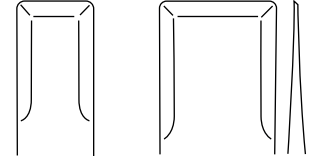


MS242 10 mm
MS243 15 mm
MS244 20 mm

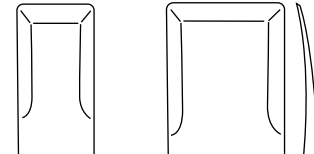


MS245 10 mm
MS246 15 mm
MS247 30 mm

TESSIER
200 mm



MS248 10 mm
MS249 15 mm



MS250 10 mm
MS251 15 mm

TESSIER
200 mm



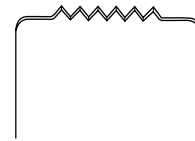
MS252
210 mm
90 x 22 mm

MS253
265 mm
120 x 28 mm

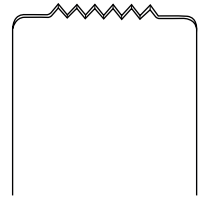


TESSIER

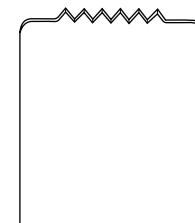
TESSIER



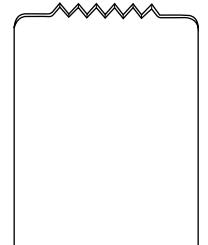
MS254
165 mm
36 x 50 mm



MS255
175 mm
52 x 50 mm



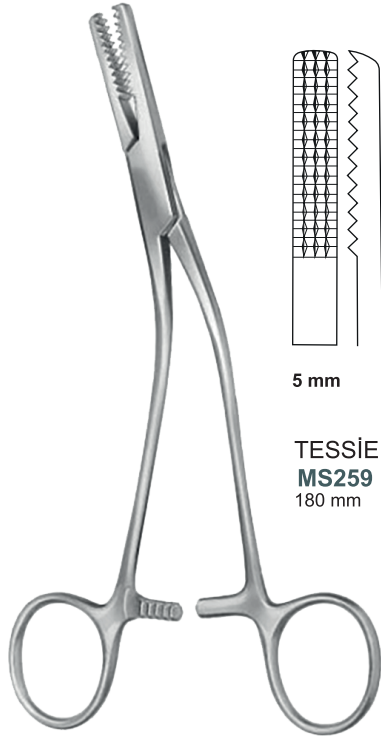
MS256
175 mm
59 x 50 mm



MS257
180 mm
66 x 50 mm



TESSIER MS258
165 mm



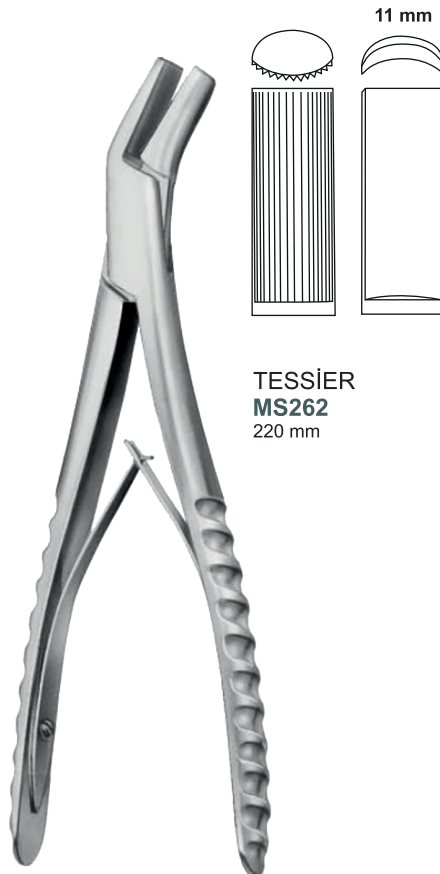
TESSIER MS259
180 mm



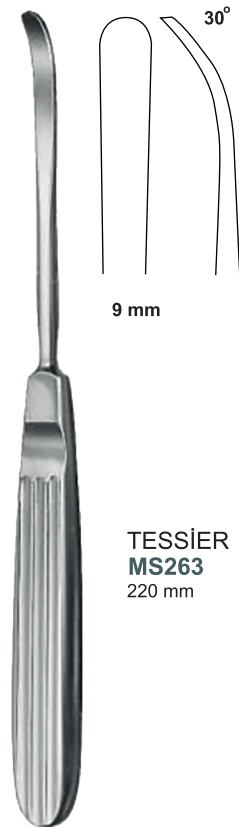
TESSIER MS260
185 mm



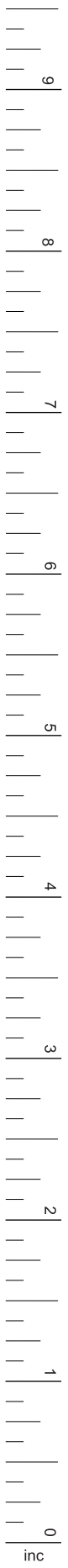
TESSIER MS261
220 mm

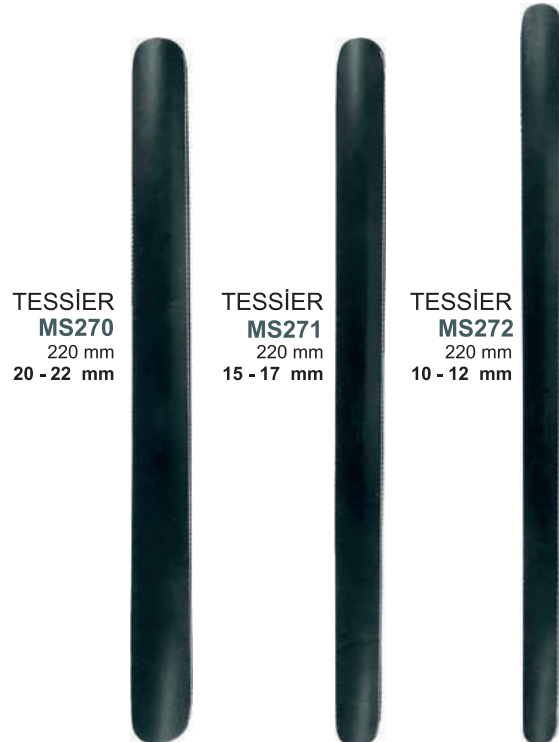
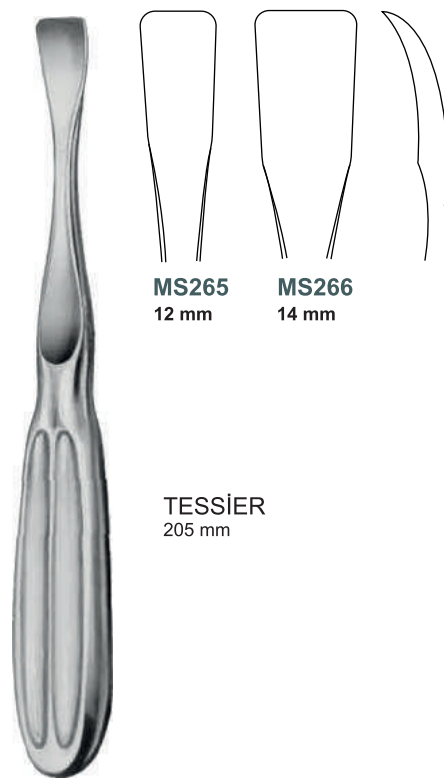
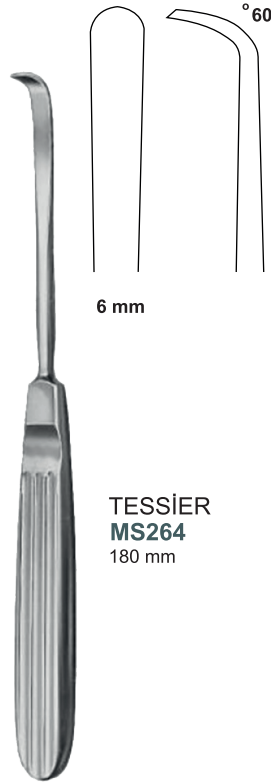
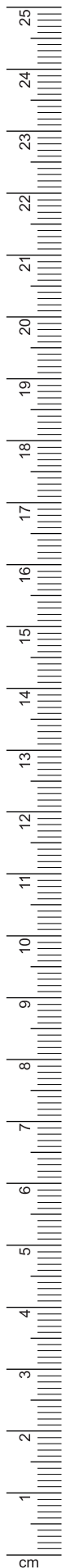


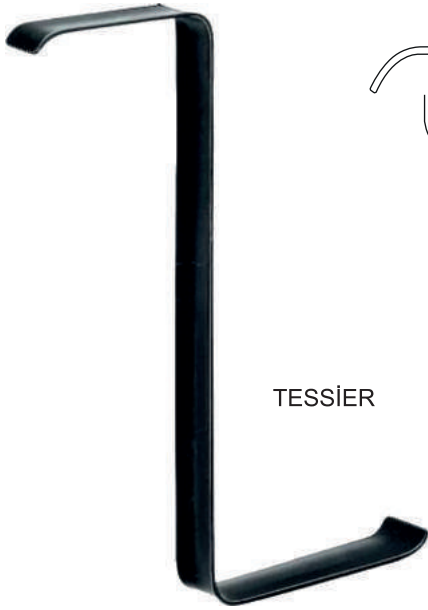
TESSIER MS262
220 mm



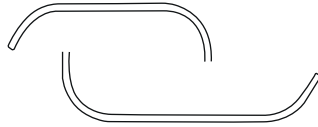
TESSIER MS263
220 mm



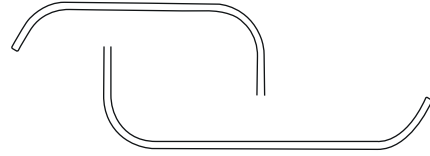




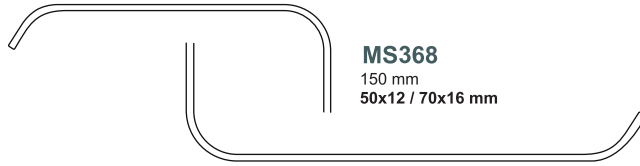
TESSIER



MS273
150 mm
30x12 / 38x16 mm



MS274
150 mm
35x12 / 45x16 mm



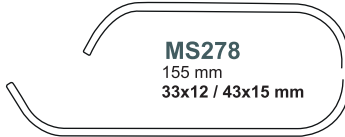
MS368
150 mm
50x12 / 70x16 mm



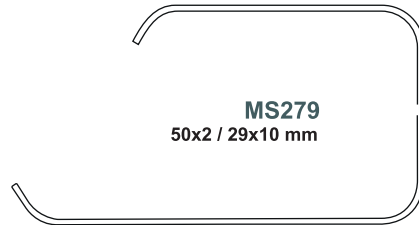
MS276
150 mm
20x13 / 30x15 mm



MS277
155 mm
28x13 / 36x15 mm



MS278
155 mm
33x12 / 43x15 mm



MS279
50x2 / 29x10 mm



MS275
19x7 / 29x10 mm



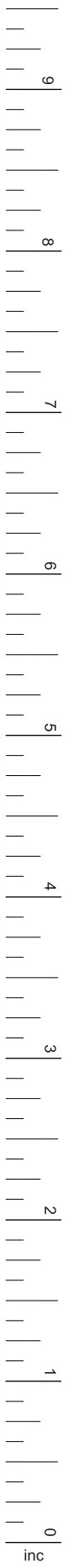
TESSIER
205 mm



TESSIER
205 mm

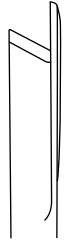


TESSIER
205 mm

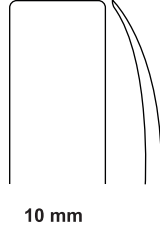




TESSIER
MS280
190 mm



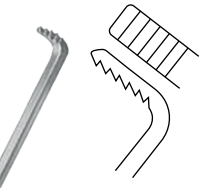
TESSIER
MS281
180 mm



10 mm



MS282
220 mm



TESSIER
MS283
190 mm

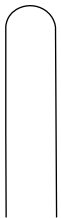


Fig.1
MS284
8 mm

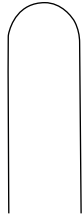


Fig.2
MS285
10 mm



Fig.3
MS286
7 mm

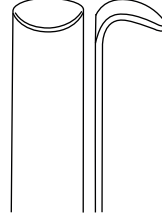


Fig.4
MS287
10 mm



Fig.5
MS288
8 mm

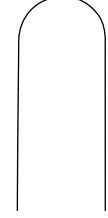


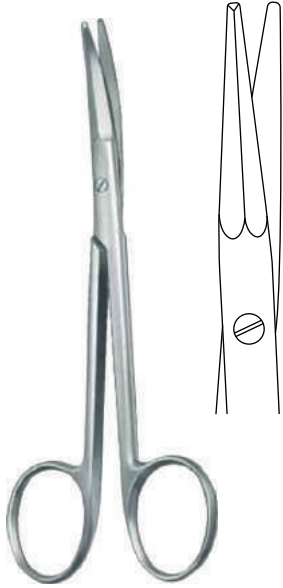
Fig.6
MS289
12 mm



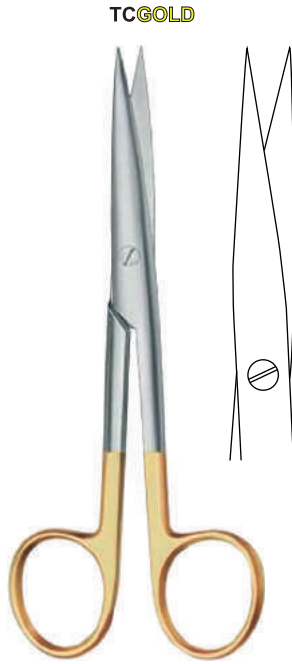
TESSIER
125 mm



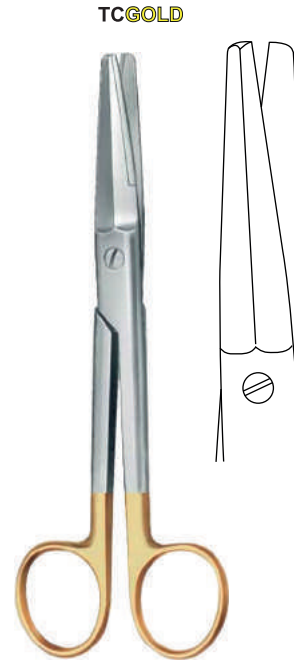
TESSIER
125 mm



**TESSIER
MS290**
130 mm



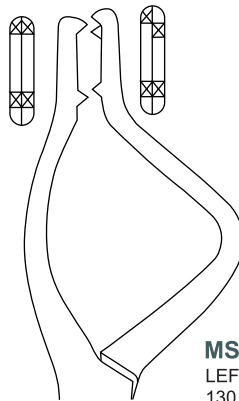
**TESSIER
MS291**
150 mm



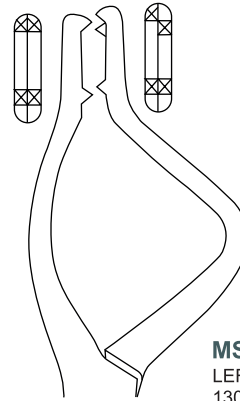
**TESSIER
MS292**
165 mm



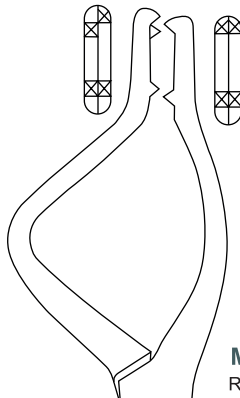
TESSIER
230 mm



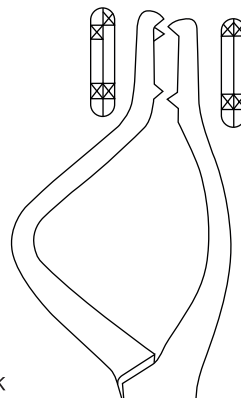
MS293
LEFT / ÇOCUK
130 mm



MS294
LEFT / YETİŞKİN
130 mm

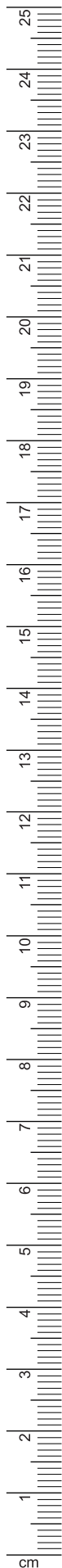


MS295
RIGHT / ÇOCUK
130 mm



MS296
RIGHT / YETİŞKİN
130 mm





MARCHAC
MS297
170 mm



MARCHAC
MS298
160 mm



TESSIER
MS299
170 mm



TESSIER
MS300
200 mm



MARCHAC
MS301
170 mm



STEINBERG
MS302
180 mm



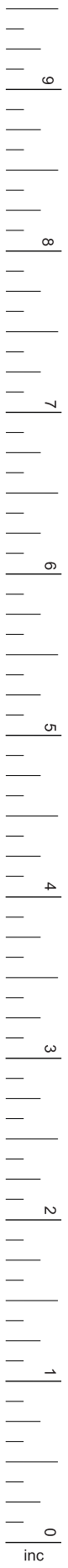
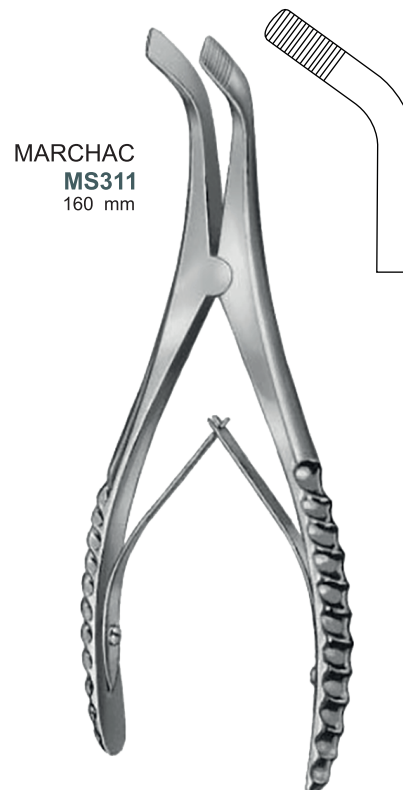
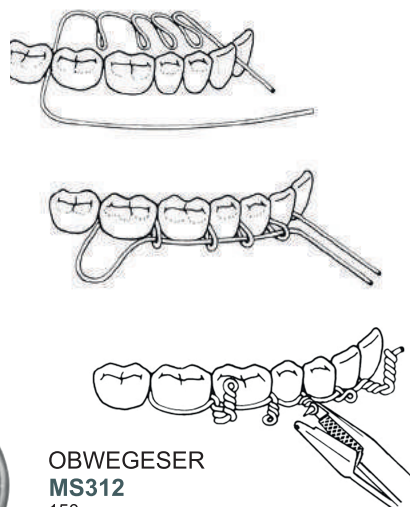
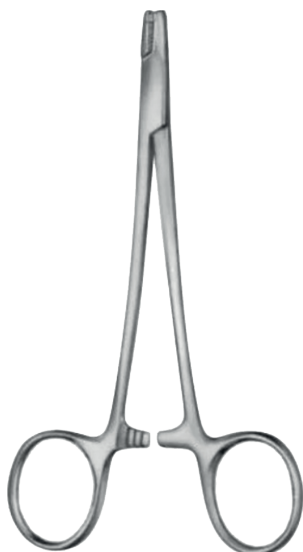
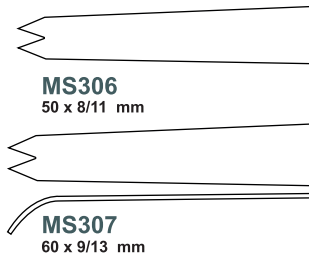
STEINBERG
MS303
195 mm

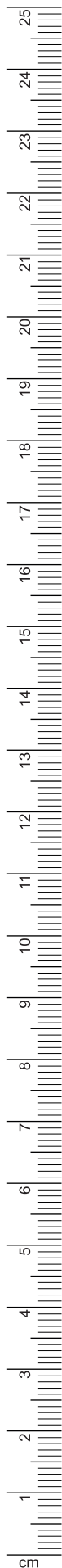


MARCHAC
MS304

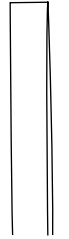


MARCHAC
MS305





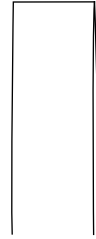
MARCHAC
160 mm



MS313
4 mm



MS314
6 mm



MS315
8 mm



MARCHAC
MS316
160 mm



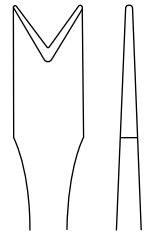
6 mm



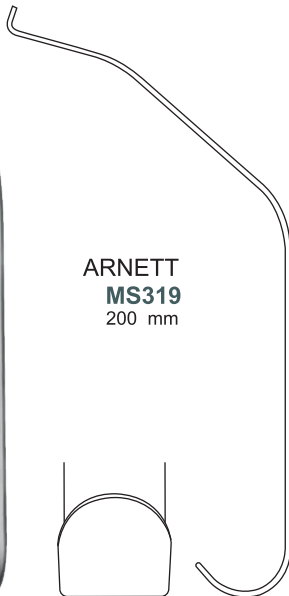
ARNETT
MS317
190 mm



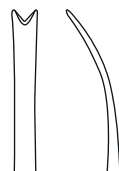
ARNETT
MS318
220 mm



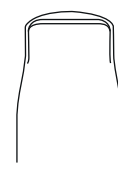
ARNETT
MS319
200 mm



ARNETT
MS320
200 mm



ARNETT
MS321
200 mm



ARNETT
MS322
165 mm





**ARNETT
MS323**



**ARNETT
MS324**
185 mm



**ARNETT
MS325**
200 mm



**ARNETT
MS326**
225 mm



**ARNETT
MS327**
230 mm



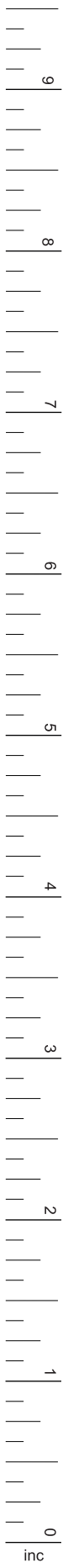
**ARNETT
MS328**
230 mm

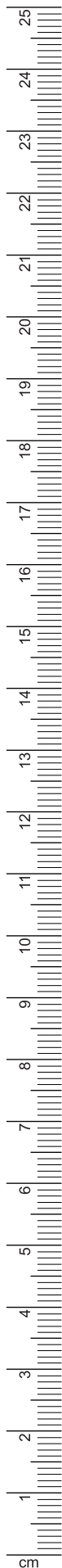


**ARNETT
MS329**
230 mm

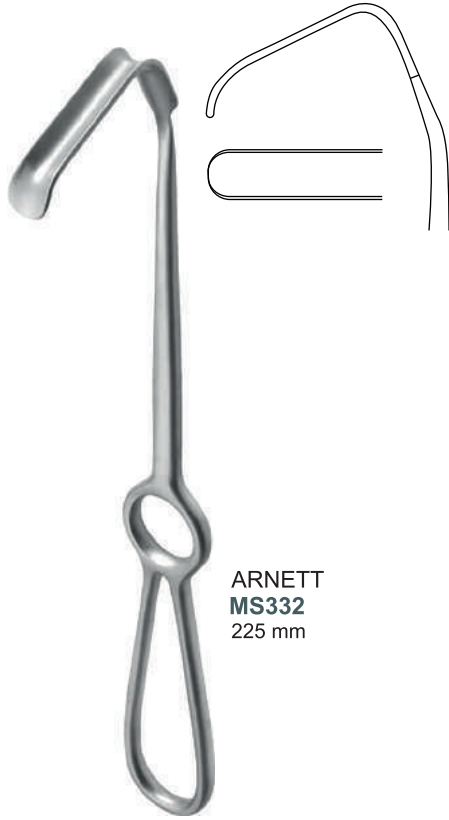


**ARNETT
MS330**
200 mm





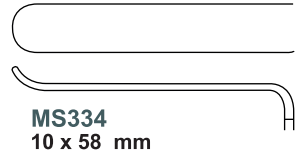
ARNETT MS331
195 mm



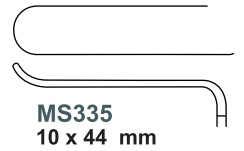
ARNETT MS332
225 mm



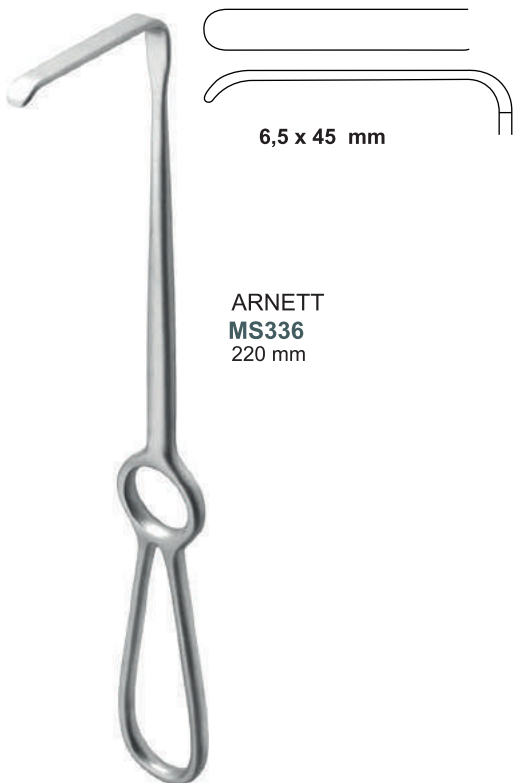
MS333
10 x 80 mm



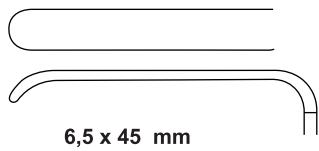
MS334
10 x 58 mm



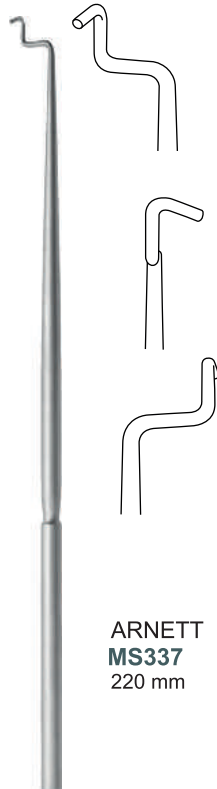
MS335
10 x 44 mm



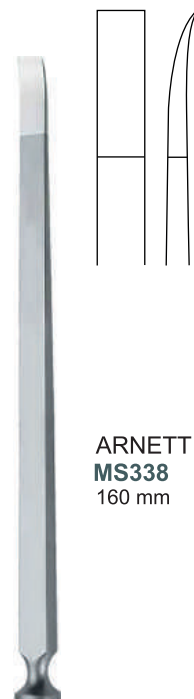
ARNETT MS336
220 mm



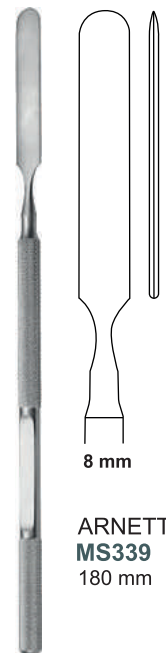
6,5 x 45 mm



ARNETT MS337
220 mm

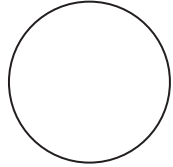


ARNETT MS338
160 mm



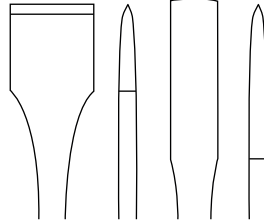
8 mm

ARNETT MS339
180 mm



Ø = 25 mm - 360 gr

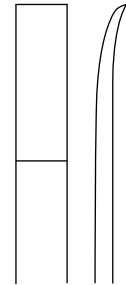
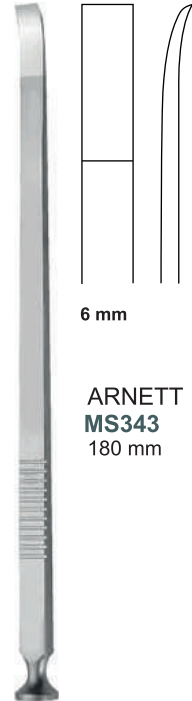
ARNETT MS340
200 mm



MS341
7 mm

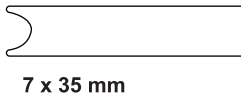
MS342
14 mm

ARNETT
200 mm



6 mm

ARNETT MS343
180 mm



7 x 35 mm

ARNETT MS344
220 mm



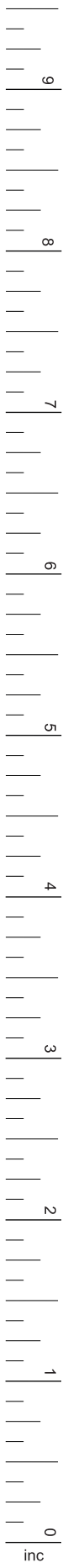
ARNETT MS345
145 mm

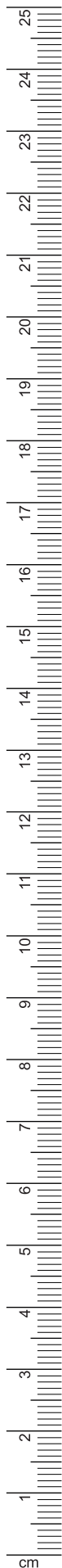


ARNETT MS346
125 mm



ARNETT MS347
130 mm





**ARNETT
MS348**
210 mm

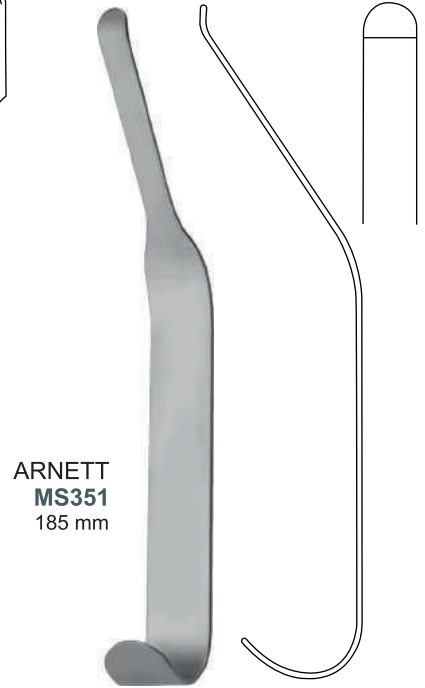


**ARNETT
MS349**
240 mm



8,5 mm

**ARNETT
MS350**
190 mm



**ARNETT
MS351**
185 mm



**LİNDORF
MS352**
180 mm

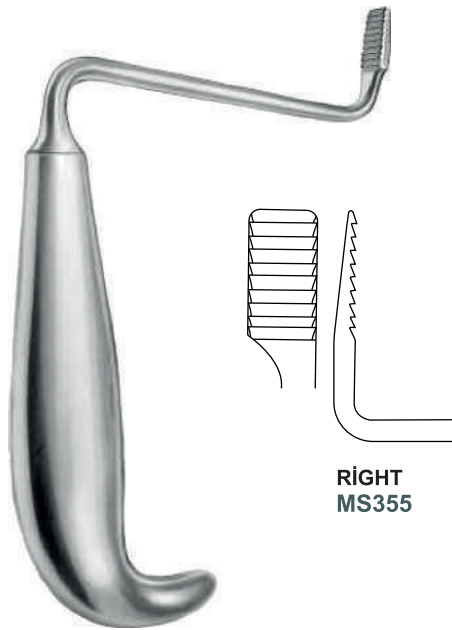
| Bıçaklar için Vida Bladers for screws | |
|--|-----|
| Cross Drive | |
| 1,5 mm | ● ⊕ |
| 2,0/2,3 mm | ● ⊕ |
| 2,7 mm | ● ⊕ |
| Cross Drive | |
| 1,5 mm | ● ⊕ |
| 2,0/2,3 mm | ● ⊕ |
| 2,7 mm | ● ⊕ |



**LİNDORF
MS353**
180 mm



**ARNETT
MS354**
185 mm

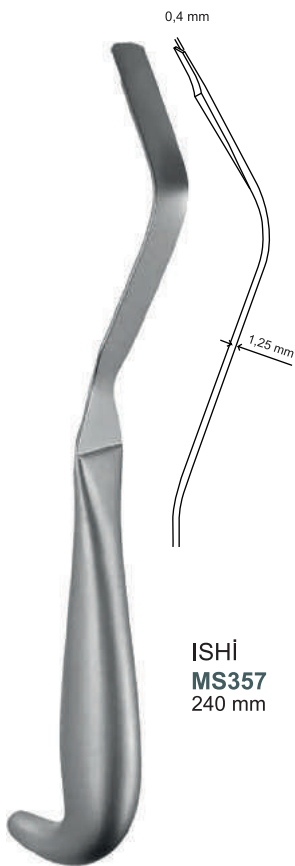


RIGHT
MS355

TESSIER
150 mm



LEFT
MS356



ISHI
MS357
240 mm



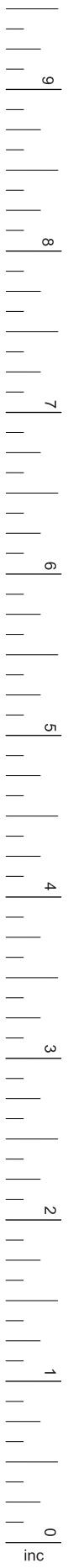
ISHI
MS358
195 mm

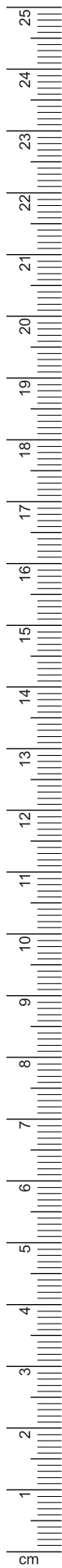


ISHI
MS359
230 mm



ISHI
MS360
245 mm





OBWEGESER
MS361
130 mm



OBWEGESER
MS362
120 mm



MS363
125 mm



MS364
130 mm



MS365
150 mm



STAMMBERGER
MS366
10 cm

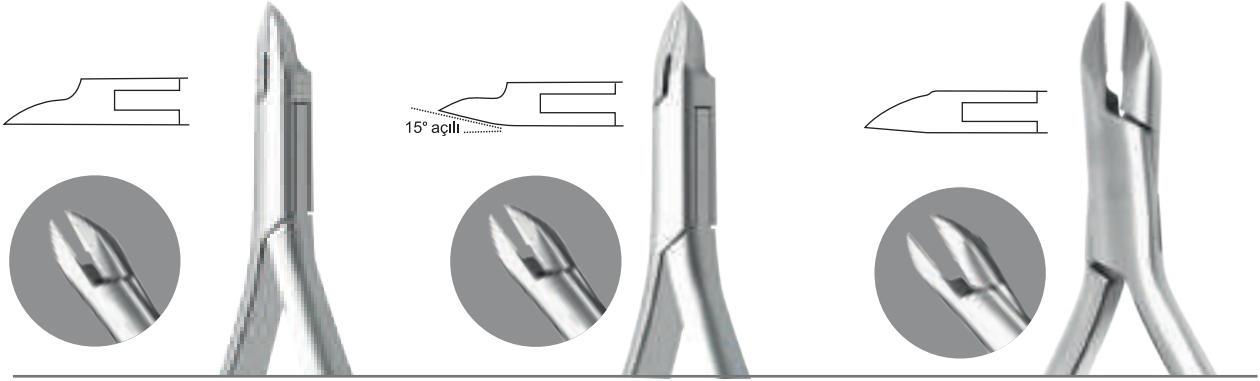


WEILL-BLAKES
MS367
120 mm



ORTODONTI
ORTHODONTICS

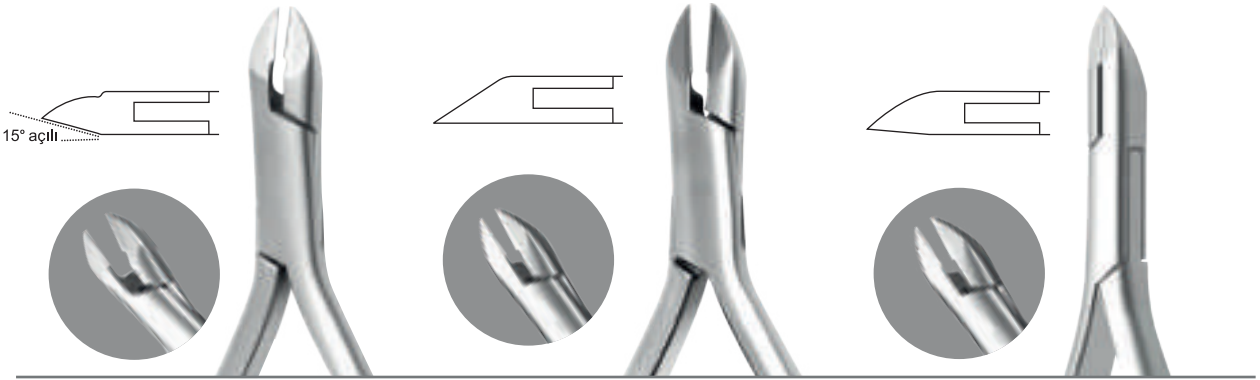




OD001
MİKRO LİGATÜR
KESİCİ
0,4 mm yumusak tel kesici.

OD002
MİKRO LİGATÜR KESİCİ
15 DERECE
0,4 mm yumusak tel kesici.

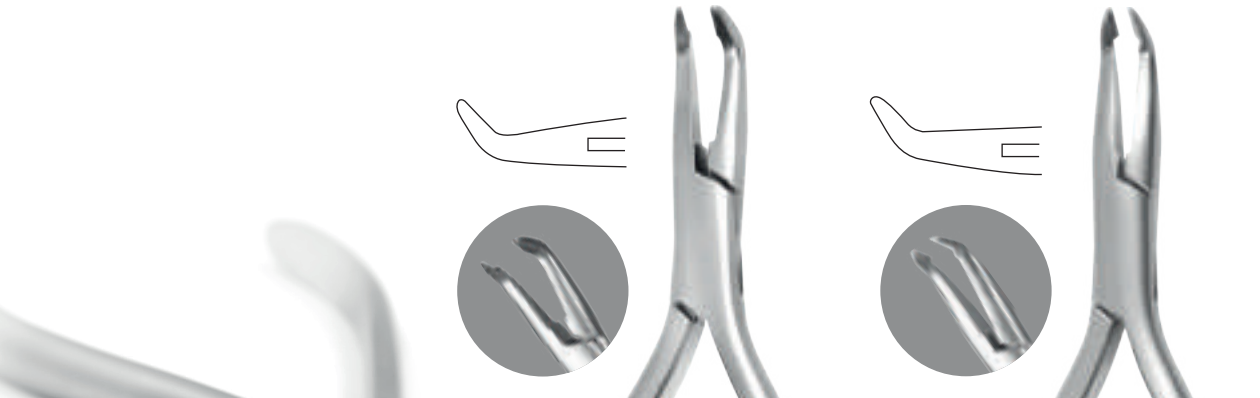
OD003
LİGATÜR KESİCİ
0,4 mm yumusak tel kesici.



OD004
LİGATÜR KESİCİ
15 DERECE
0,4 mm yumusak tel kesici.

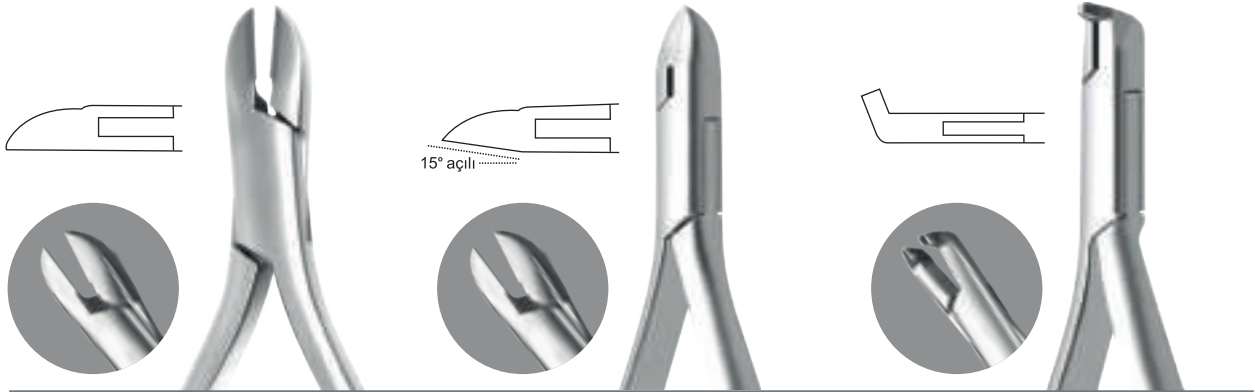
OD005
LİGATÜR KESİCİ
UZUN SAP
0,4 mm yumusak tel kesici.

OD006
LİGATÜR KESİCİ
UZUN AĞIZ
0,4 mm yumusak tel kesici.



OD007
TERS LİGATÜR KESİCİ
40 DERECE
0,4 mm yumusak tel kesici.

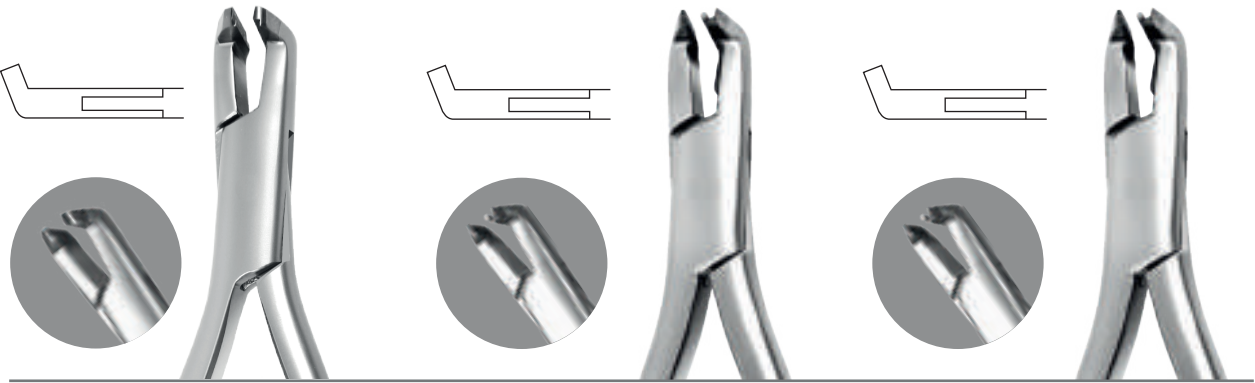
OD008
LİGATÜR KESİCİ
40 DERECE
0,4 mm yumusak tel kesici.



OD009
SERT TEL KESİCİ
0,6 - 0,7 mm arası kesebilir.

OD010
SERT TEL KESİCİ
15 DERECE
0,6 - 0,7 mm arası kesebilir.

OD011
MİNİ DİSTAL
KESİCİ
0,6 - 0,7 mm arası kesebilir.



OD012
DİSTAL KESİCİ
UZUN SAP
0,6 - 0,7 mm arası kesebilir.

OD013
FLUSH DİSTAL
KESİCİ
0,5 mm tel için uygundur.

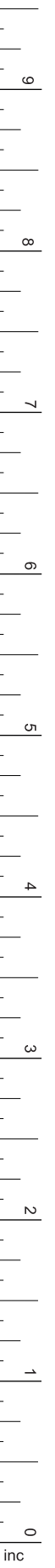
OD014
FLUSH DİSTAL
KESİCİ UZUN SAP
0,5 mm tel için uygundur.

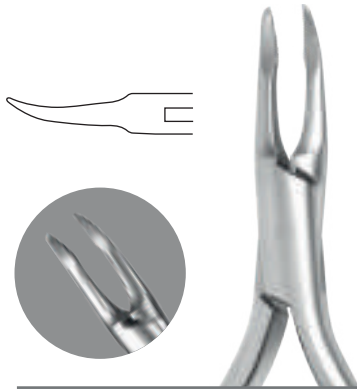


OD015
LABORATUVAR SERT
TEL KESİCİ
0,7 - 0,9 mm arası uygundur.

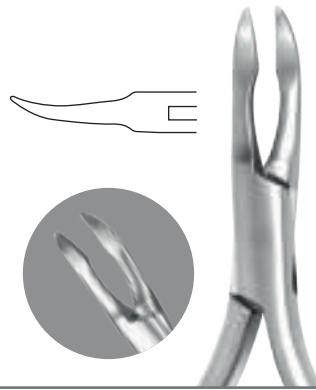


OD016
LABORATUVAR SERT TEL
KESİCİ PLASTİK SAP
1,0 - 1,5 mm arası uygundur.

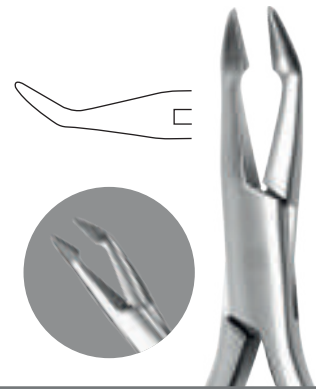




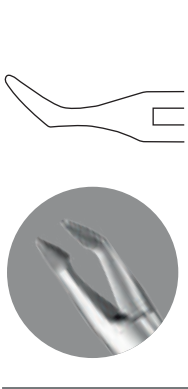
OD017
WEINGART PENİSİ
SLİM
0,5 mm'e kadar uygundur.



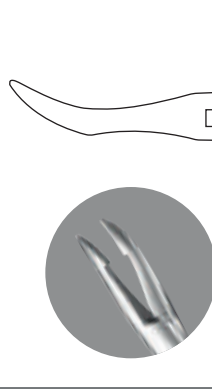
OD018
WEINGART PENİSİ
0,5 mm'e kadar uygundur.



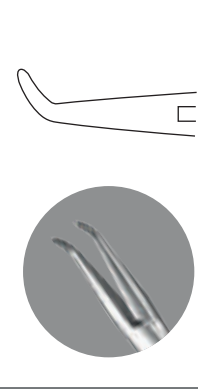
OD019
WEINGART PENİSİ
AÇILI UZUN AĞIZLI
0,5 mm'e kadar uygundur.



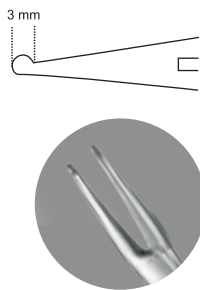
OD020
WEINGART PENİSİ
AÇILI KISA AĞIZLI
0,5 mm'e kadar uygundur.



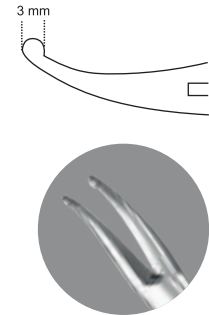
OD021
WEINGART PENİSİ
BÜYÜK
0,5 mm'e kadar uygundur.



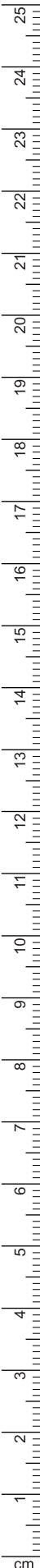
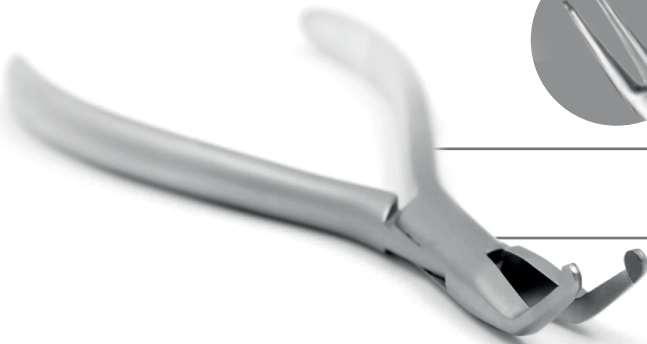
OD022
WEINGART PENİSİ
LİNGUAL
0,5 mm'e kadar uygundur.

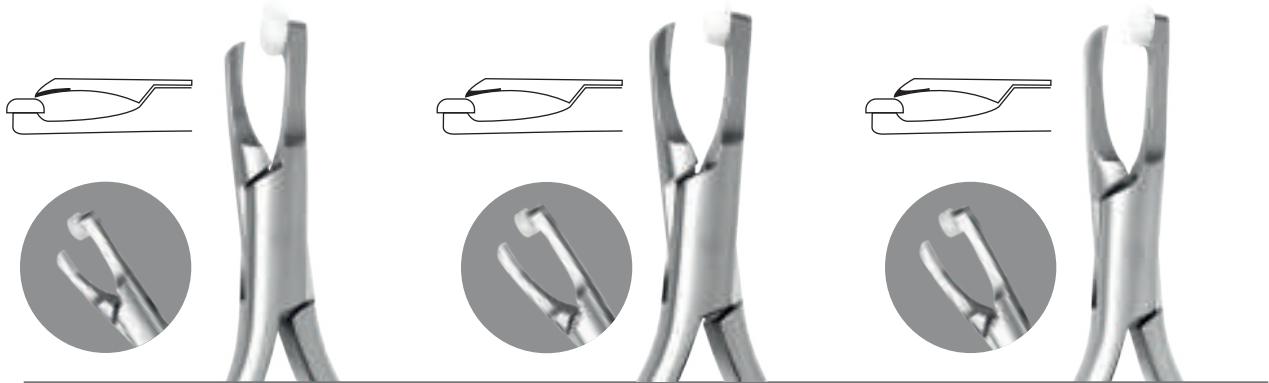


OD023
HOW PENİSİ
DÜZ



OD024
HOW PENİSİ
EĞRİ

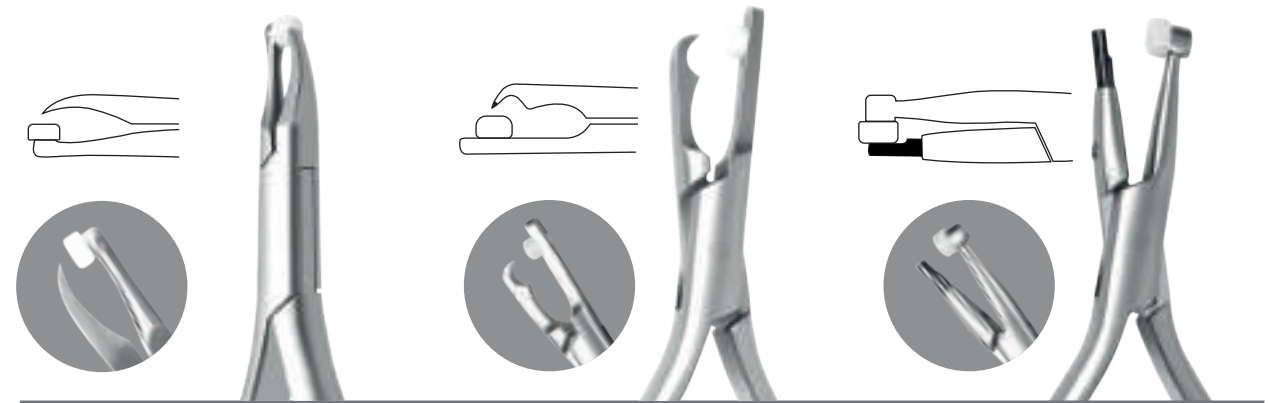




OD025
POSTERIOR BANT
SÖKÜCÜ PENS KISA

OD026
POSTERIOR BANT
SÖKÜCÜ PENS ORTA

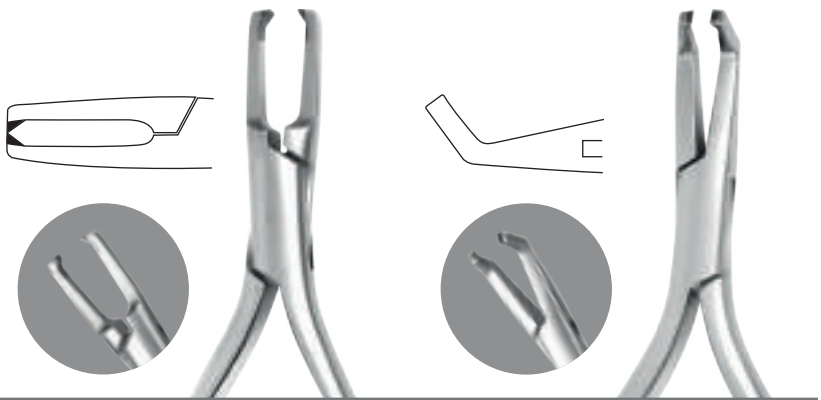
OD027
POSTERIOR BANT
SÖKÜCÜ PENS UZUN



OD028
MİKRO POSTERIOR
BANT SÖKÜCÜ KESKİN

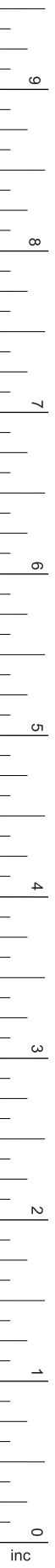
OD029
BRAKET ve ADHESİVE
SÖKÜCÜ PENS

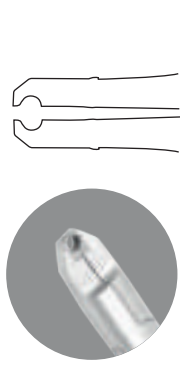
OD030
ADHESİVE
SÖKÜCÜ PENS



OD031
DÜZ BRAKET
SÖKÜCÜ PENS

OD032
AÇILI BRAKET
SÖKÜCÜ PENS

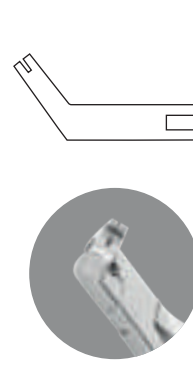




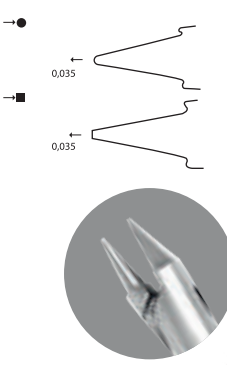
OD033
DEBONDİNG PENS
DÜZ



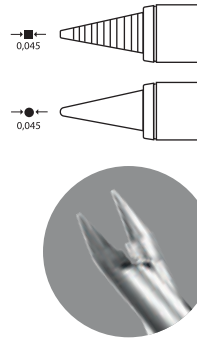
OD034
DEBONDİNG PENS
EĞRİ



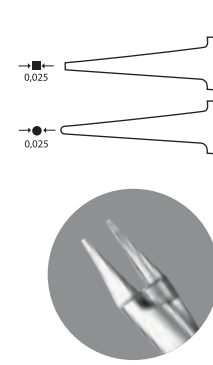
OD035
DEBONDİNG PENS
KANALLI



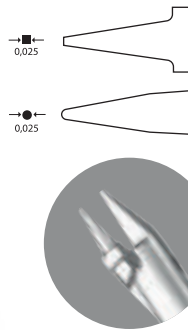
OD036
BIRD BEAK
PENSİ
0,7 mm'e kadar uygundur.



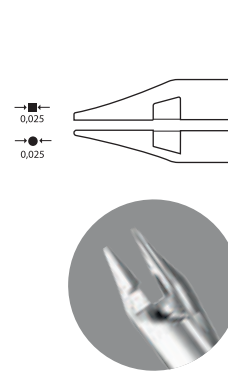
OD037
BIRD BEAK
PENSİ TIRTIKLI
0,7 mm'e kadar uygundur.



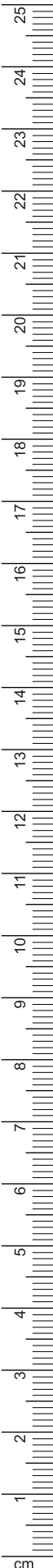
OD038
BIRD BEAK PENSİ
UZUN AĞIZ
0,7 mm'e kadar uygundur.

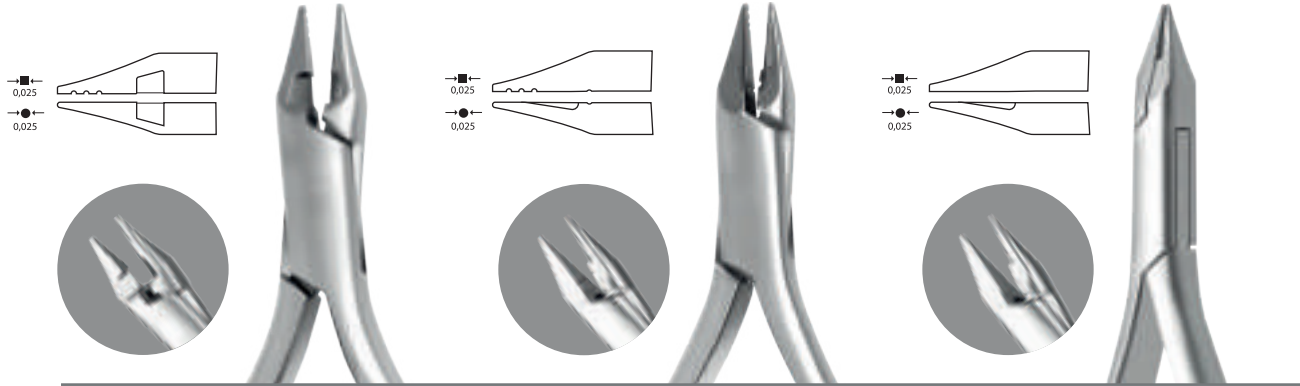


OD039
MİKRO BIRD
BEAK PENSİ
0,7 mm'e kadar uygundur.



OD040
KESİCİ MİKRO BIRD
BEAK PENSİ
0,7 mm'e kadar uygundur.

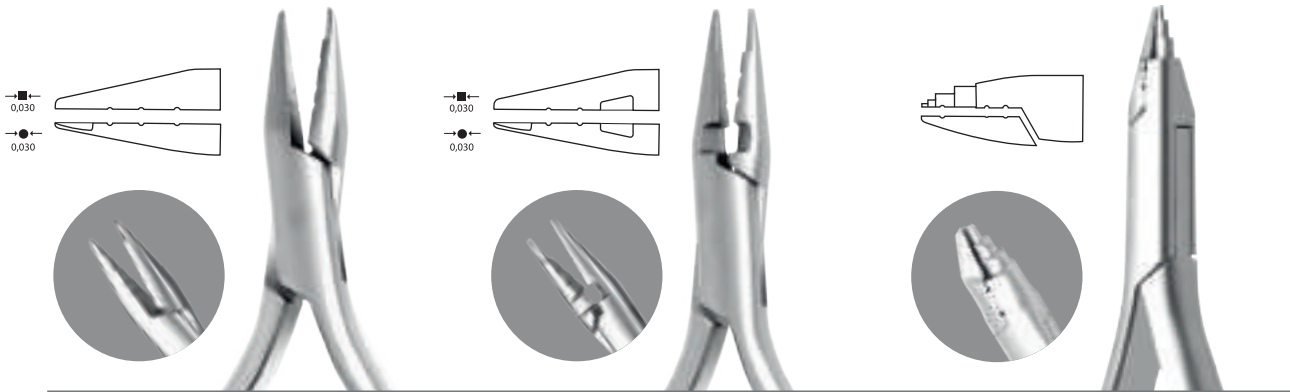




OD041
KESİCİ 3 KANALLI
BIRD BEAK PENSİ
0,5 mm'e kadar uygundur.

OD042
3 KANALLI
BIRD BEAK PENSİ
0,5 mm'e kadar uygundur.

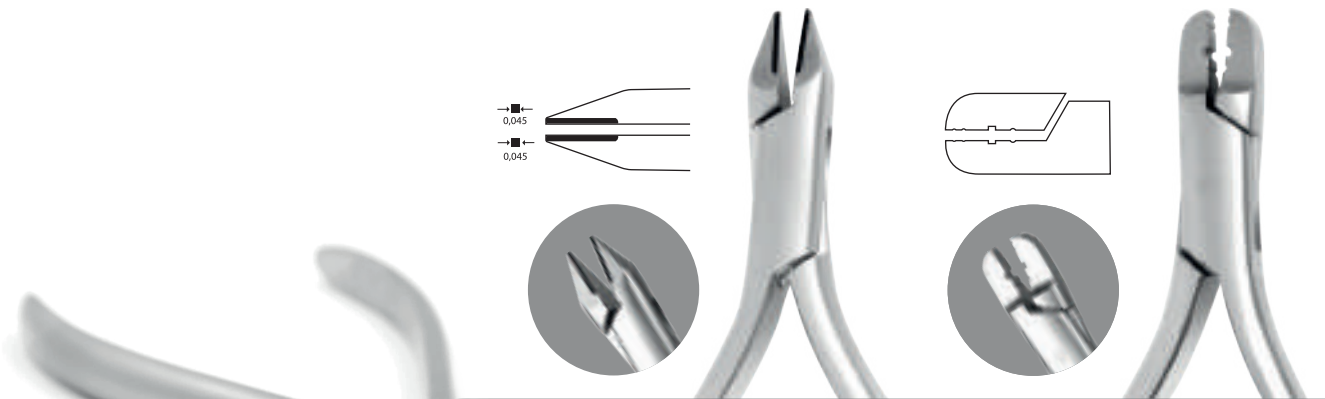
OD043
LIGHT BIRD
BEAK PENSİ
0,5 mm'e kadar uygundur.



OD044
JARABAK
PENSİ
0,5 mm'e kadar uygundur.

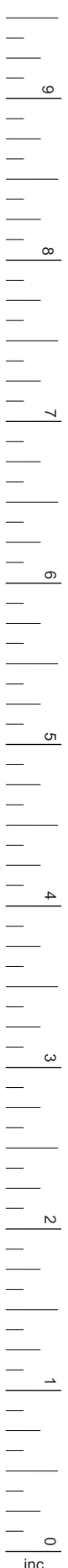
OD045
KESİCİ
JARABAK PENSİ
0,5 mm'e kadar uygundur.

OD046
YOUNG
PENSİ
0,7 mm'e kadar uygundur.

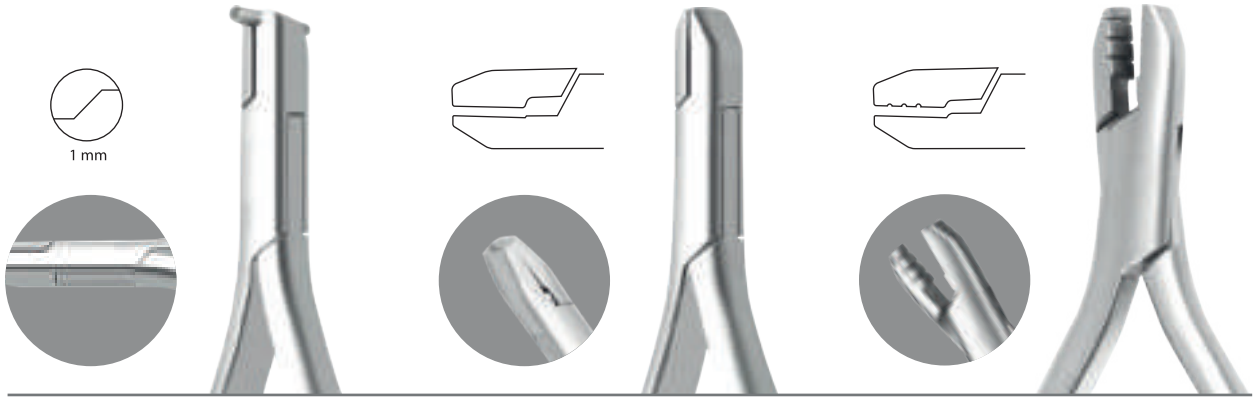


OD047
ADAM
PENSİ
0,8 mm'e kadar uygundur.

OD048
LINGUAL ARK
FORM PENSİ
0,9 mm'e kadar uygundur.



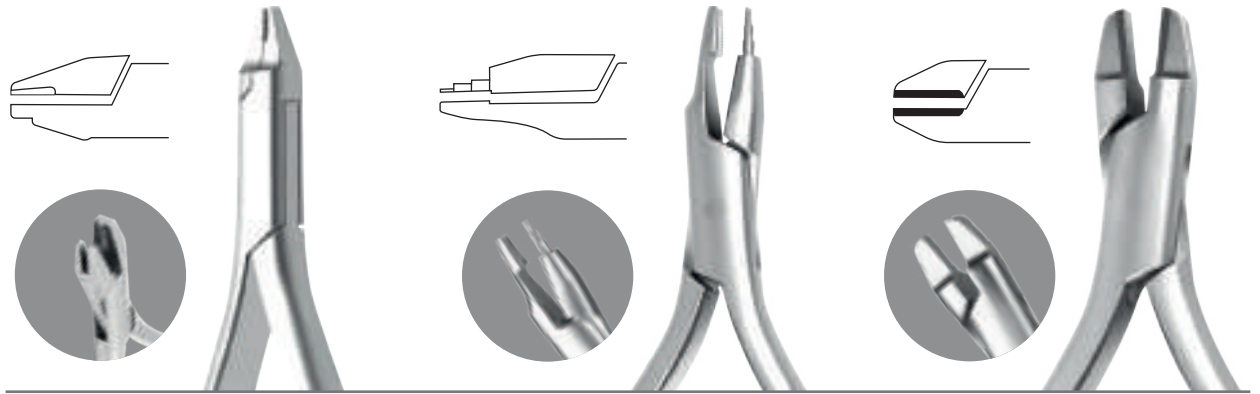
inc



OD049
STEP PENSİ
1,0 mm'e kadar uygundur.

OD050
DE LA ROSA
PENSİ
1,0 mm'e kadar uygundur.

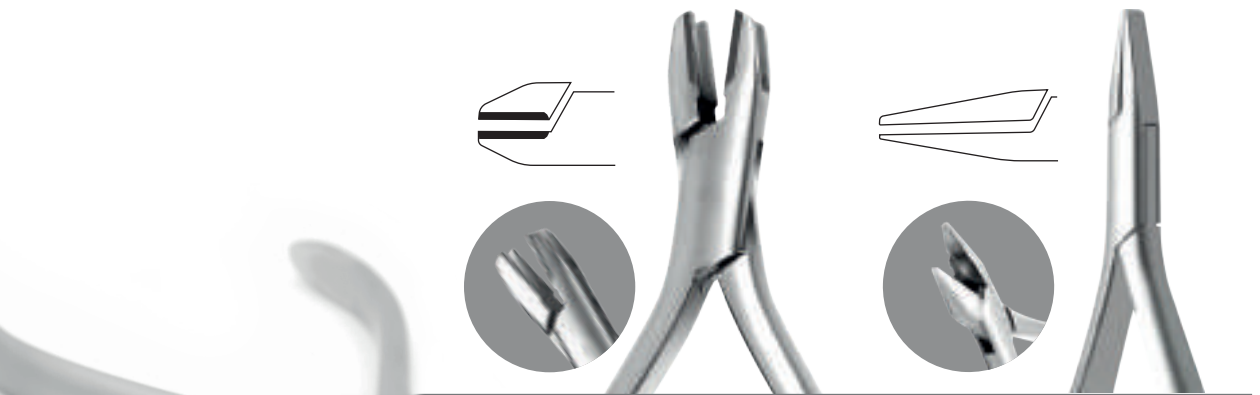
OD051
KANALLI DE LA
ROSA PENSİ



OD052
CRIMPING
PENSİ

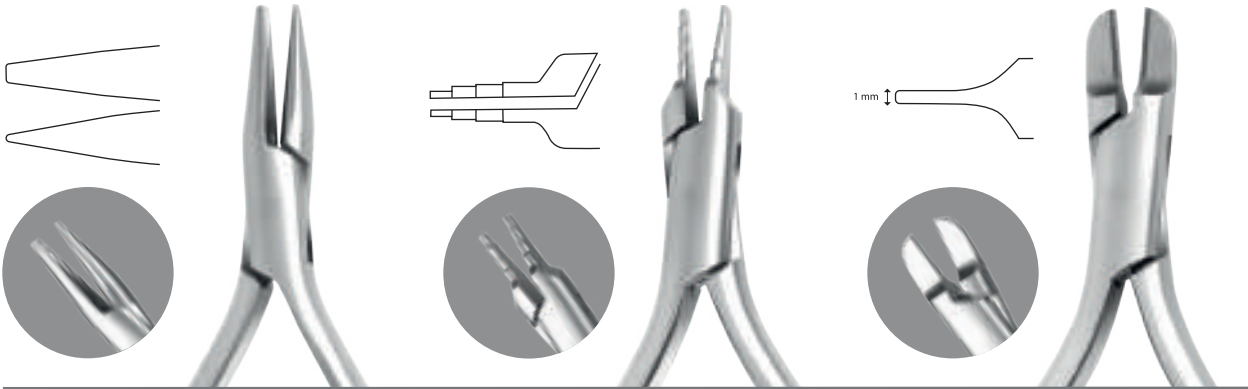
OD053
TWEED LOOP
FORMİNG PENSİ
0,5 mm'e kadar uygundur.

OD054
TORK PENSİ
ERKEK



OD055
TORK PENSİ
DİŞİ

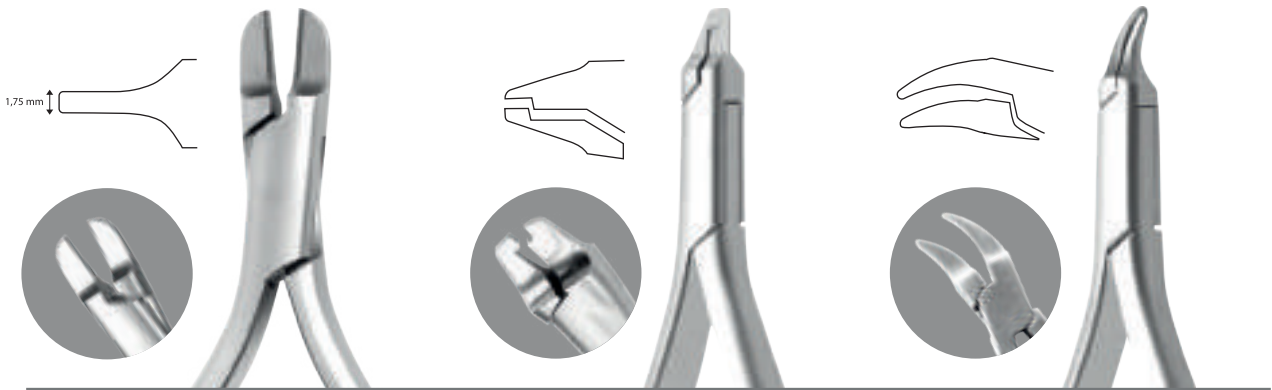
OD056
HOLLOW
PENSİ



OD057
OPTİK
PENSİ
0,5 mm'e kadar uygundur.

OD058
NANCE
PENSİ
0,7 mm'e kadar uygundur.

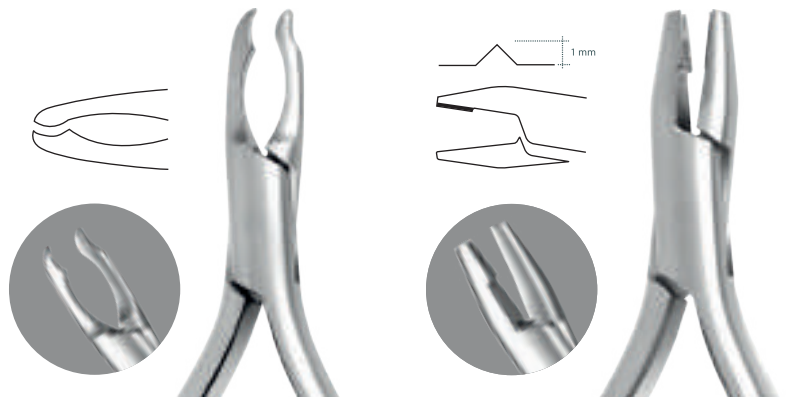
OD059
TWEED PENSİ
1,0 mm'e kadar uygundur.



OD060
TWEED PENSİ
2,0 mm'e kadar uygundur.

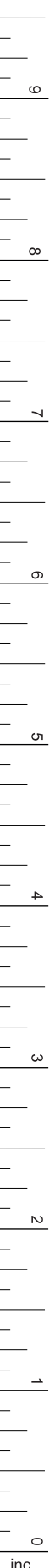
OD061
KRON ve BANT
PENSİ

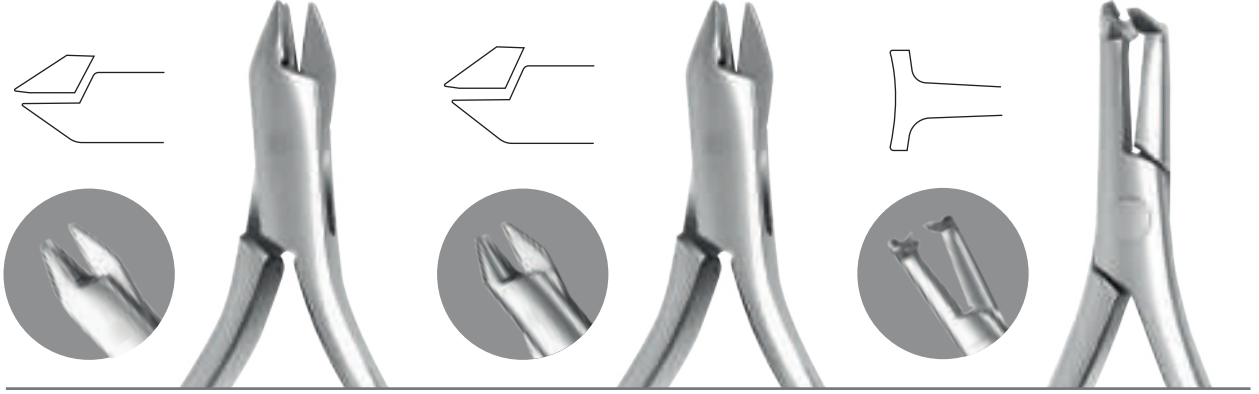
OD062
REYNOLDS
PENSİ



OD063
KONTUR
PENSİ

OD064
V-BÜKÜM
PENSİ
1,0 mm'e kadar uygundur.

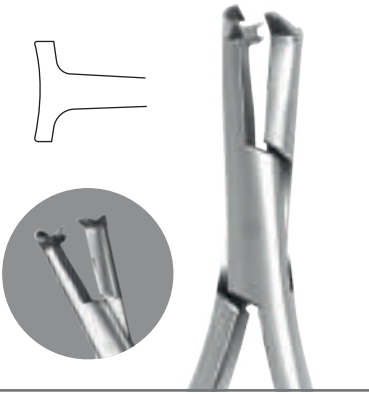




OD065
MİNİ ÜÇ PARMAK
PENSİ
0,5 mm'e kadar uygundur.

OD066
ÜÇ PARMAK PENSİ
0,5 mm'e kadar uygundur.

OD067
ÇEKİÇ BAŞLI
PENS UZUN SAPLI
0,4 mm'e kadar uygundur.



OD068
ÇEKİÇ BAŞLI
PENS
0,4 mm'e kadar uygundur.

OD069
SEPERETÖR
PENSİ



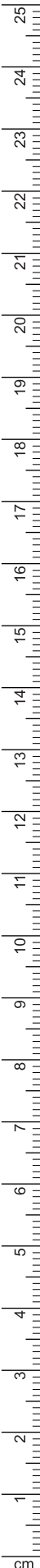
OD070
SEPERETÖR
PENSİ İNCE



OD071
LİGATÜR
BAĞLAMA PENSİ



OD072
SEPERETÖR PENSİ
OVAL SAP

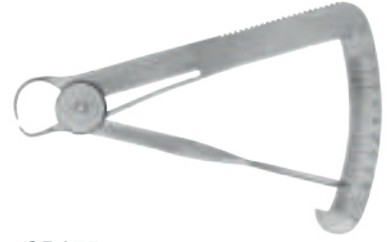




OD073
CHECK
EKARTÖRÜ



OD074
BOONE BRAKET
KONUMLANDIRICI



OD075
İVANSON
KUMPAS



OD076
BANT OTURTUCU



OD077
BRAKET KONUMLANDIRICI
DÜZ



OD079
BOLEY
KUMPAS

OD080
BOLEY KUMPAS
SİVRİ UÇ



OD078
BRAKET KONUMLANDIRICI
OYNAR BAŞLI



OD081
LİGATÜR TAKICI
DÜZ ve EĞRİ



OD082
LİGATÜR TAKICI



OD083
LİGATÜR TAKICI
MEDIUM



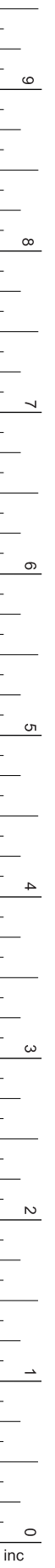
OD084
MERSHON
BANT İTİCİ



OD085
TURET



OD086
BANT OTURTUCU



inc

BRAKET TUTUCULAR



OD087
125 mm



OD088
125 mm



OD089
125 mm



OD090
125 mm



OD091
125 mm



OD092
125 mm



OD093
125 mm



OD094
125 mm



OD095
125 mm





KONTEYNER SİSTEMLERİ

CONTAINER SYSTEMS



1/1 Bio-Barrier Model

W: 285 mm

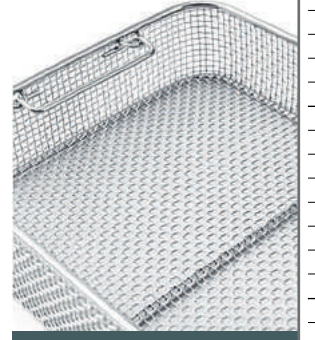
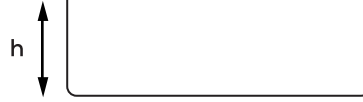
L: 600 mm



| ÖZELLİKLER | Kapak (bariyer ile) | Kapak (bariyer ile) | Güvenlik Kapağı Kapak (bariyer ile) | Güvenlik Kapağı Kapak (bariyer ile) | | | |
|------------|---------------------|---------------------|--|--|---------------|---------------|---------------|
| | | | | | | | |
| | Kutu (Deliksiz) | Kutu (bariyer ile) | Kutu (Deliksiz) | Kutu (bariyer ile) | | | |
| | B1-001 | B1-025 | B1-055 | B1-085 | | | |
| | B1-002 | | | | B1-026 | B1-056 | B1-086 |
| | B1-003 | | | | B1-027 | B1-057 | B1-087 |
| | B1-004 | | | | B1-028 | B1-058 | B1-088 |
| | B1-005 | | | | B1-029 | B1-059 | B1-089 |
| | B1-006 | | | | B1-030 | B1-060 | B1-090 |
| | B1-007 | B1-031 | B1-061 | B1-091 | | | |
| | B1-008 | | | | B1-032 | B1-062 | B1-092 |
| | B1-009 | | | | B1-033 | B1-063 | B1-093 |
| | B1-010 | | | | B1-034 | B1-064 | B1-094 |
| | B1-011 | | | | B1-035 | B1-065 | B1-095 |
| | B1-012 | | | | B1-036 | B1-066 | B1-096 |
| | B1-013 | B1-037 | B1-067 | B1-097 | | | |
| | B1-014 | | | | B1-038 | B1-068 | B1-098 |
| | B1-015 | | | | B1-039 | B1-069 | B1-099 |
| | B1-016 | | | | B1-040 | B1-070 | B1-100 |
| | B1-017 | | | | B1-041 | B1-071 | B1-101 |
| | B1-018 | | | | B1-042 | B1-072 | B1-102 |
| | B1-019 | B1-043 | B1-073 | B1-103 | | | |
| | B1-020 | | | | B1-044 | B1-074 | B1-104 |
| | B1-021 | | | | B1-045 | B1-075 | B1-105 |
| | B1-022 | | | | B1-046 | B1-076 | B1-106 |
| | B1-023 | | | | B1-047 | B1-077 | B1-107 |
| | B1-024 | | | | B1-048 | B1-078 | B1-108 |
| | B1-025 | B1-049 | B1-079 | B1-109 | | | |
| | B1-026 | | | | B1-050 | B1-080 | B1-110 |
| | B1-027 | | | | B1-051 | B1-081 | B1-111 |
| | B1-028 | | | | B1-052 | B1-082 | B1-112 |
| | B1-029 | | | | B1-053 | B1-083 | B1-113 |
| | B1-024 | | | | B1-054 | B1-084 | B1-114 |

Tel Sepet

Paslanmaz çelik hasırdan yapılmış sepet

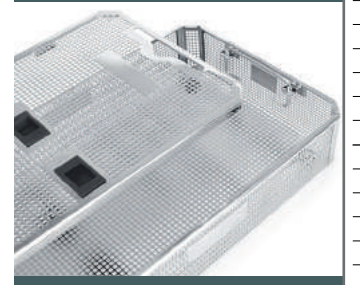


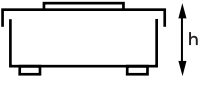
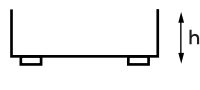

| kod | dış boyut |
|---------------|----------------------|
| B2-001 | 540 x 245 x h:30 mm |
| B2-002 | 540 x 245 x h:50 mm |
| B2-003 | 540 x 245 x h:70 mm |
| B2-004 | 540 x 245 x h:100 mm |

| kod | dış boyut |
|---------------|----------------------|
| B2-005 | 480 x 245 x h:30 mm |
| B2-006 | 480 x 245 x h:50 mm |
| B2-007 | 480 x 245 x h:70 mm |
| B2-008 | 480 x 245 x h:100 mm |

Sepet (standlı)

Paslanmaz çelik sacdan yapılmış sepet

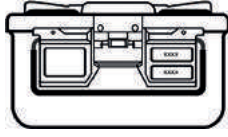


| | kod | dış boyut |
|--|---------------|----------------------------------|
| Kutu ve Kapak  | B3-001 | 491 x 259 x h:44 mm |
| | B3-002 | 491 x 259 x h:64 mm |
| | B3-003 | 491 x 259 x h:84 mm |
| | B3-004 | 491 x 259 x h:114 mm |
| Kutu  | B3-005 | 485 x 253 x h:40 mm |
| | B3-006 | 485 x 253 x h:60 mm |
| | B3-007 | 485 x 253 x h:80 mm |
| | B3-008 | 485 x 253 x h:110 mm |
| Kapak  | B3-009 | SADECE KAPAKLI, sepetler için |

3/4 Bio-Barrier Model

W: 285 mm

L: 475 mm



| ÖZELLİKLER | Kapak (bariyer ile) | Kapak (bariyer ile) | Güvenlik Kapağı Kapak (bariyer ile) | Güvenlik Kapağı Kapak (bariyer ile) |
|------------|---------------------|---------------------|--|--|
| | | | | |
| | Kutu (Deliksiz) | Kutu (bariyer ile) | Kutu (Deliksiz) | Kutu (bariyer ile) |
| | B1-150 | B1-169 | B1-187 | B1-205 |
| | B1-152 | B1-170 | B1-188 | B1-206 |
| | B1-153 | B1-171 | B1-189 | B1-207 |
| | B1-154 | B1-172 | B1-190 | B1-208 |
| | B1-155 | B1-173 | B1-191 | B1-209 |
| | B1-156 | B1-174 | B1-192 | B1-210 |
| | B1-157 | B1-175 | B1-193 | B1-211 |
| | B1-158 | B1-176 | B1-194 | B1-212 |
| | B1-159 | B1-177 | B1-195 | B1-213 |
| | B1-160 | B1-178 | B1-196 | B1-214 |
| | B1-161 | B1-179 | B1-197 | B1-215 |
| | B1-162 | B1-180 | B1-198 | B1-216 |
| | B1-163 | B1-181 | B1-199 | B1-217 |
| | B1-164 | B1-182 | B1-200 | B1-218 |
| | B1-165 | B1-183 | B1-201 | B1-219 |
| | B1-166 | B1-184 | B1-202 | B1-220 |
| | B1-167 | B1-185 | B1-203 | B1-221 |
| | B1-168 | B1-186 | B1-204 | B1-222 |

Tel Sepet

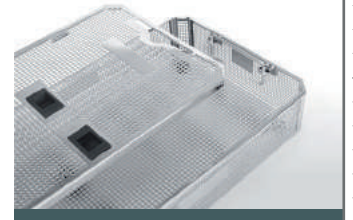
Paslanmaz çelik hasırdan yapılmış sepet

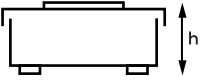
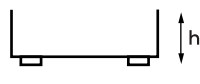
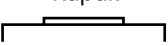


| kod | dış boyut |
|---------------|----------------------|
| B2-010 | 405 x 245 x h:30 mm |
| B2-011 | 405 x 245 x h:50 mm |
| B2-012 | 405 x 245 x h:70 mm |
| B2-013 | 405 x 245 x h:100 mm |

Sepet (standlı)

Paslanmaz çelik sacdan yapılmış sepet

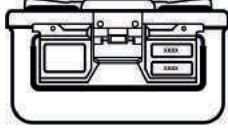


| | kod | dış boyut |
|--|---------------|----------------------------------|
| Kutu ve Kapak  | B3-015 | 411 x 259 x h:44 mm |
| | B3-016 | 411 x 259 x h:64 mm |
| | B3-017 | 411 x 259 x h:84 mm |
| | B3-018 | 411 x 259 x h:114 mm |
| Kutu  | B3-019 | 405 x 253 x h:40 mm |
| | B3-020 | 405 x 253 x h:60 mm |
| | B3-021 | 405 x 253 x h:80 mm |
| | B3-022 | 405 x 253 x h:110 mm |
| Kapak  | B3-023 | SADECE KAPAKLI, sepetler için |

1/2 Bio-Barrier Model

W: 280 mm

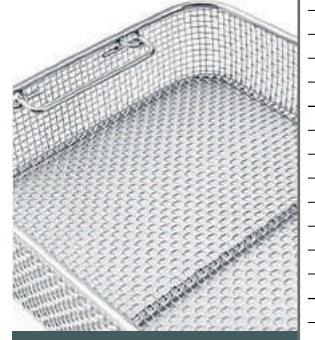
L: 310 mm



| ÖZELLİKLER | Kapak (bariyer ile) | Kapak (bariyer ile) | Güvenlik Kapağı Kapak (bariyer ile) | Güvenlik Kapağı Kapak (bariyer ile) |
|------------|---------------------|---------------------|--|--|
| | | | | |
| | Kutu (Deliksiz) | Kutu (bariyer ile) | Kutu (Deliksiz) | Kutu (bariyer ile) |
| | B1-225 | B1-255 | B1-285 | B1-315 |
| | B1-226 | B1-256 | B1-286 | B1-316 |
| | B1-227 | B1-257 | B1-287 | B1-317 |
| | B1-228 | B1-258 | B1-288 | B1-318 |
| | B1-229 | B1-259 | B1-289 | B1-319 |
| | B1-230 | B1-260 | B1-290 | B1-320 |
| | B1-231 | B1-261 | B1-291 | B1-321 |
| | B1-232 | B1-262 | B1-292 | B1-322 |
| | B1-233 | B1-263 | B1-293 | B1-323 |
| | B1-234 | B1-264 | B1-294 | B1-324 |
| | B1-235 | B1-265 | B1-295 | B1-325 |
| | B1-236 | B1-266 | B1-296 | B1-326 |
| | B1-237 | B1-267 | B1-297 | B1-327 |
| | B1-238 | B1-268 | B1-298 | B1-328 |
| | B1-239 | B1-269 | B1-299 | B1-329 |
| | B1-240 | B1-270 | B1-300 | B1-330 |
| | B1-241 | B1-271 | B1-301 | B1-331 |
| | B1-242 | B1-272 | B1-302 | B1-332 |
| | B1-243 | B1-273 | B1-303 | B1-333 |
| | B1-244 | B1-274 | B1-304 | B1-334 |
| | B1-245 | B1-275 | B1-305 | B1-335 |
| | B1-246 | B1-276 | B1-306 | B1-336 |
| | B1-247 | B1-277 | B1-307 | B1-337 |
| | B1-248 | B1-278 | B1-308 | B1-338 |
| | B1-249 | B1-279 | B1-309 | B1-339 |
| | B1-250 | B1-280 | B1-310 | B1-330 |
| | B1-251 | B1-281 | B1-311 | B1-331 |
| | B1-252 | B1-282 | B1-312 | B1-332 |
| | B1-253 | B1-283 | B1-313 | B1-333 |
| | B1-254 | B1-284 | B1-314 | B1-334 |

Tel Sepet

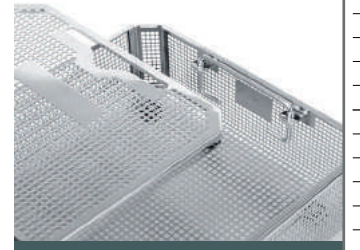
Paslanmaz çelik hasırdan yapılmış sepet

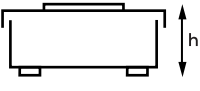
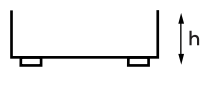



| kod | dış boyut |
|---------------|----------------------|
| B2-015 | 246 x 246 x h:30 mm |
| B2-016 | 246 x 246 x h:50 mm |
| B2-017 | 246 x 246 x h:70 mm |
| B2-018 | 246 x 246 x h:100 mm |

Sepet (standlı)

Paslanmaz çelik sacdan yapılmış sepet



| | kod | dış boyut |
|--|---------------|----------------------------------|
| Kutu ve Kapak  | B3-025 | 250 x 259 x h:44 mm |
| | B3-026 | 250 x 259 x h:64 mm |
| | B3-027 | 250 x 259 x h:84 mm |
| | B3-028 | 250 x 259 x h:114 mm |
| Kutu  | B3-029 | 244 x 253 x h:40 mm |
| | B3-030 | 244 x 253 x h:60 mm |
| | B3-031 | 244 x 253 x h:80 mm |
| | B3-032 | 244 x 253 x h:110 mm |
| Kapak  | B3-033 | SADECE KAPAKLI, sepetler için |

9
8
7
6
5
4
3
2
1
0
inc

1/1 Full Size - B3 Model

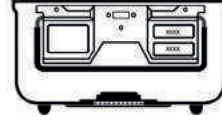


Dış boyut

L: 600 mm

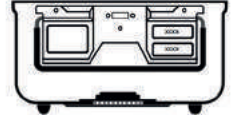
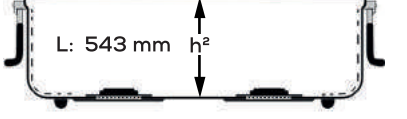


W: 272 mm



İç boyut

L: 543 mm

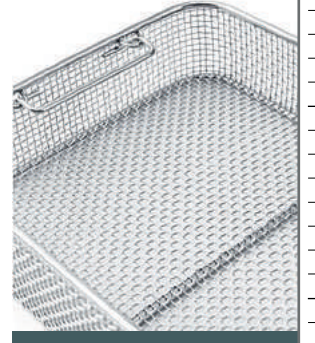
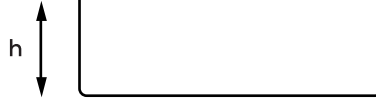


W: 258 mm

| YÜKSEKLİK | ÖZELLİKLER | PTFE | VALVE | BIOSTOP |
|-------------------------|------------|----------------|----------------|----------------|
| h: 100 mm h²: 63 mm | | A1-001P | A1-006V | A1-011B |
| h: 130 mm h²: 81 mm | | A1-002P | A1-007V | A1-012B |
| h: 150 mm h²: 101 mm | | A1-003P | A1-008V | A1-013B |
| h: 200 mm h²: 153 mm | | A1-004P | A1-009V | A1-014B |
| h: 250 mm h²: 199 mm | | A1-005P | A1-010V | A1-015B |

Tel Sepet

Paslanmaz çelik hasırdan yapılmış sepet

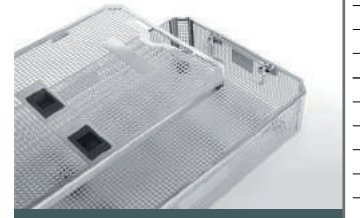




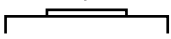
| kod | dış boyut |
|---------------|----------------------|
| B2-001 | 540 x 245 x h:30 mm |
| B2-002 | 540 x 245 x h:50 mm |
| B2-003 | 540 x 245 x h:70 mm |
| B2-004 | 540 x 245 x h:100 mm |

| kod | dış boyut |
|---------------|----------------------|
| B2-005 | 480 x 245 x h:30 mm |
| B2-006 | 480 x 245 x h:50 mm |
| B2-007 | 480 x 245 x h:70 mm |
| B2-008 | 480 x 245 x h:100 mm |

Sepet (standlı)

Paslanmaz çelik sacdan yapılmış sepet



| | kod | dış boyut |
|--|---------------|----------------------------------|
| Kutu ve Kapak  | B3-001 | 491 x 259 x h:44 mm |
| | B3-002 | 491 x 259 x h:64 mm |
| | B3-003 | 491 x 259 x h:84 mm |
| | B3-004 | 491 x 259 x h:114 mm |
| Kutu  | B3-005 | 485 x 253 x h:40 mm |
| | B3-006 | 485 x 253 x h:60 mm |
| | B3-007 | 485 x 253 x h:80 mm |
| | B3-008 | 485 x 253 x h:110 mm |
| Kapak  | B3-009 | SADECE KAPAKLI, sepetler için |

3/4 Quarter Size - B3 Model

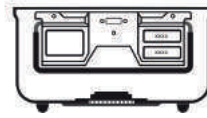


Dış boyut

L: 475 mm

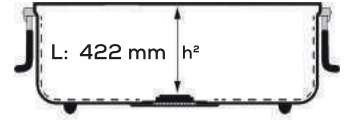


W: 272 mm

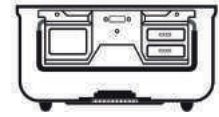


İç boyut

L: 422 mm h²



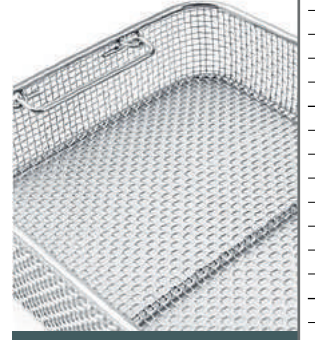
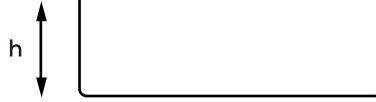
W: 258 mm



| YÜKSEKLİK | ÖZELLİKLER | PTFE | VALVE | BIOSTOP |
|-------------------------|------------|----------------|----------------|----------------|
| h: 100 mm h²: 63 mm | | A1-016P | A1-019V | A1-022B |
| h: 130 mm h²: 81 mm | | A1-017P | A1-020V | A1-023B |
| h: 150 mm h²: 101 mm | | A1-018P | A1-021V | A1-024B |

Tel Sepet

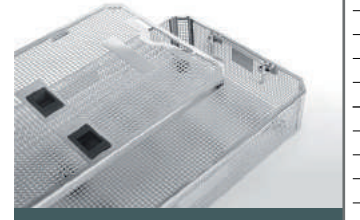
Paslanmaz çelik hasırdan yapılmış sepet

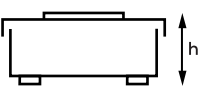
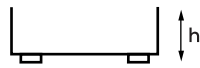



| kod | dış boyut |
|---------------|----------------------|
| B2-010 | 405 x 245 x h:30 mm |
| B2-011 | 405 x 245 x h:50 mm |
| B2-012 | 405 x 245 x h:70 mm |
| B2-013 | 405 x 245 x h:100 mm |

Sepet (standlı)

Paslanmaz çelik sacdan yapılmış sepet



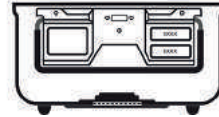
| | kod | dış boyut |
|--|---------------|----------------------------------|
| Kutu ve Kapak  | B3-015 | 411 x 259 x h:44 mm |
| | B3-016 | 411 x 259 x h:64 mm |
| | B3-017 | 411 x 259 x h:84 mm |
| | B3-018 | 411 x 259 x h:114 mm |
| Kutu  | B3-019 | 405 x 253 x h:40 mm |
| | B3-020 | 405 x 253 x h:60 mm |
| | B3-021 | 405 x 253 x h:80 mm |
| | B3-022 | 405 x 253 x h:110 mm |
| Kapak  | B3-023 | SADECE KAPAKLI, sepetler için |

1/2 Half Size - B3 Model



Dış boyut

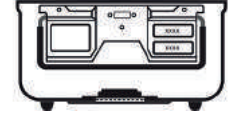
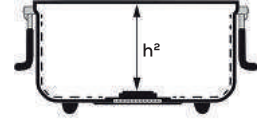
L: 310 mm



W: 272 mm

İç boyut

L: 253 mm

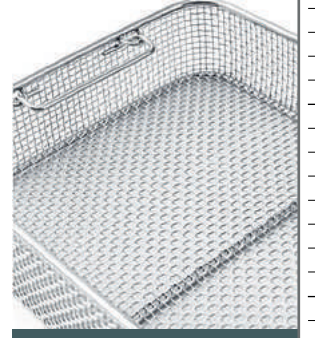


W: 258 mm

| YÜKSEKLİK | ÖZELLİKLER | PTFE | VALVE | BIOSTOP |
|-------------------------|------------|----------------|----------------|----------------|
| h: 110 mm h²: 63 mm | | A1-025P | A1-030V | A1-035B |
| h: 130 mm h²: 81 mm | | A1-026P | A1-031V | A1-036B |
| h: 150 mm h²: 101 mm | | A1-027P | A1-032V | A1-037B |
| h: 200 mm h²: 153 mm | | A1-028P | A1-033V | A1-038B |
| h: 250 mm h²: 199 mm | | A1-029P | A1-034V | A1-039B |

Tel Sepet

Paslanmaz çelik hasırdan yapılmış sepet

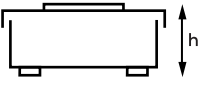
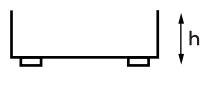



| kod | dış boyut |
|---------------|----------------------|
| B2-015 | 246 x 246 x h:30 mm |
| B2-016 | 246 x 246 x h:50 mm |
| B2-017 | 246 x 246 x h:70 mm |
| B2-018 | 246 x 246 x h:100 mm |

Sepet (standlı)

Paslanmaz çelik sacdan yapılmış sepet



| | kod | dış boyut |
|--|---------------|----------------------------------|
| Kutu ve Kapak  | B3-025 | 250 x 259 x h:44 mm |
| | B3-026 | 250 x 259 x h:64 mm |
| | B3-027 | 250 x 259 x h:84 mm |
| | B3-028 | 250 x 259 x h:114 mm |
| Kutu  | B3-029 | 244 x 253 x h:40 mm |
| | B3-030 | 244 x 253 x h:60 mm |
| | B3-031 | 244 x 253 x h:80 mm |
| | B3-032 | 244 x 253 x h:110 mm |
| Kapak  | B3-033 | SADECE KAPAKLI, sepetler için |

Large Dental Model



W: 255 mm

L: 280 mm



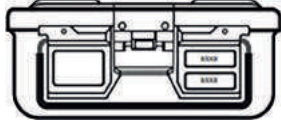
ÖZELLİKLER

Kapak (Delikli)

YÜKSEKLİK



h: 115 mm



Kutu (Deliksiz)

D1-001



D1-002



D1-003



D1-004



D1-005



D1-006



D1-007



D1-008



D1-009



D1-010



D1-011



D1-012



D1-013



D1-014



D1-015



D1-016



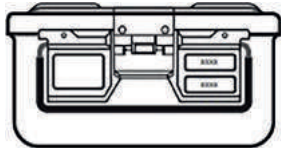
D1-017



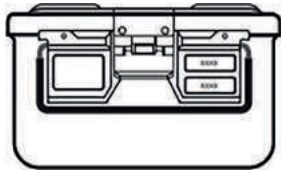
D1-018



h: 130 mm

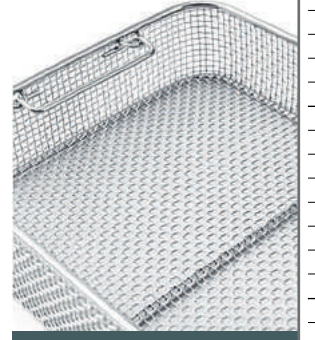
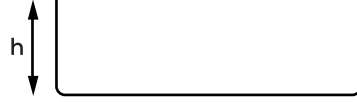


h: 150 mm



Tel Sepet

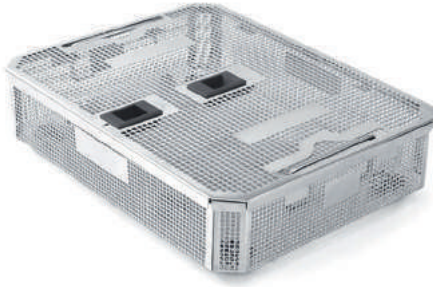
Paslanmaz çelik hasırdan yapılmış sepet

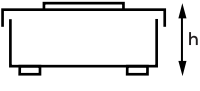
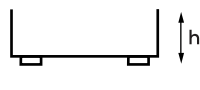
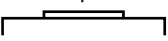


| kod | dış boyut |
|---------------|----------------------|
| D2-001 | 323 x 222 x h:50 mm |
| D2-002 | 323 x 222 x h:70 mm |
| D2-003 | 323 x 222 x h:100 mm |

Sepet (standlı)

Paslanmaz çelik sacdan yapılmış sepet



| | kod | dış boyut |
|--|---------------|----------------------------------|
| Kutu ve Kapak  | D3-001 | 320 x 220 x h:63 mm |
| | D3-002 | 320 x 220 x h:83 mm |
| | D3-003 | 320 x 220 x h:113 mm |
| Kutu  | D3-004 | 315 x 215 x h:60 mm |
| | D3-005 | 315 x 215 x h:80 mm |
| | D3-006 | 315 x 215 x h:110 mm |
| Kapak  | D3-007 | SADECE KAPAKLI, sepetler için |

Dental Model

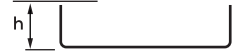
| YÜKSEKLİK | ÖZELLİKLER | Kapak (Delikli) | Kapak (Delikli) | Kapak (Deliksiz) | Kapak (Delikli) | Kapak (Delikli) |
|--------------------|------------|-----------------|-----------------|------------------|-----------------|-----------------|
| | | Kutu (Deliksiz) | Kutu (Delikli) | Kutu (Deliksiz) | Kutu (Deliksiz) | Kutu (Delikli) |
| 325 X 192 X 55 mm | | D1-020 | D1-038 | D1-056 | D1-074 | N/A |
| | | D1-021 | D1-039 | D1-057 | D1-075 | |
| | | D1-022 | D1-040 | D1-058 | D1-076 | |
| | | D1-023 | D1-041 | D1-059 | D1-077 | |
| | | D1-024 | D1-042 | D1-060 | D1-078 | |
| | | D1-025 | D1-043 | D1-061 | D1-079 | |
| 325 X 190 X 70 mm | | D1-026 | D1-044 | D1-062 | D1-080 | D1-092 |
| | | D1-027 | D1-045 | D1-063 | D1-081 | D1-093 |
| | | D1-028 | D1-046 | D1-064 | D1-082 | D1-094 |
| | | D1-029 | D1-047 | D1-065 | D1-083 | D1-095 |
| | | D1-030 | D1-048 | D1-066 | D1-084 | D1-096 |
| | | D1-031 | D1-049 | D1-067 | D1-085 | D1-097 |
| 325 X 190 X 135 mm | | D1-032 | D1-050 | D1-068 | D1-086 | D1-098 |
| | | D1-033 | D1-051 | D1-069 | D1-087 | D1-099 |
| | | D1-034 | D1-052 | D1-070 | D1-088 | D1-100 |
| | | D1-035 | D1-053 | D1-071 | D1-089 | D1-101 |
| | | D1-036 | D1-054 | D1-072 | D1-090 | D1-102 |
| | | D1-037 | D1-055 | D1-073 | D1-091 | D1-103 |

TEL SEPET (Kapaklı)



| kod | dış boyut |
|---------------|---------------------|
| D2-005 | 270 x 175 x h:45 mm |

TEL SEPET (Kapaksız)



| kod | dış boyut |
|---------------|---------------------|
| D2-006 | 270 x 170 x h:45 mm |

DEPOLAMA ÇERÇEVESİ



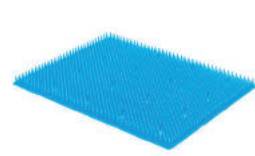
| kod | dış boyut |
|---------------|-------------------|
| D4-001 | 273 x 180 x 13 mm |

ÖRTÜ TUTUCU



| kod | dış boyut |
|---------------|--------------|
| D4-002 | 277 x 175 mm |

SİLİKON ÇİM



| kod | dış boyut |
|---------------|--------------|
| D4-003 | 260 x 180 mm |

1/2 Dental Model

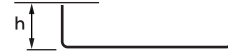
| YÜKSEKLİK | ÖZELLİKLER | Kapak (Delikli) | Kapak (Delikli) | Kapak (Deliksiz) |
|--------------------|------------|-----------------|-----------------|------------------|
| | | Kutu (Deliksiz) | Kutu (Delikli) | Kutu (Deliksiz) |
| 232 X 174 X 63 mm | | D1-150 | D1-168 | D1-186 |
| | | D1-151 | D1-169 | D1-187 |
| | | D1-152 | D1-170 | D1-188 |
| | | D1-153 | D1-171 | D1-189 |
| | | D1-154 | D1-172 | D1-190 |
| | | D1-155 | D1-173 | D1-191 |
| | | D1-156 | D1-174 | D1-192 |
| 232 X 174 X 100 mm | | D1-157 | D1-175 | D1-193 |
| | | D1-158 | D1-176 | D1-194 |
| | | D1-159 | D1-177 | D1-195 |
| | | D1-160 | D1-178 | D1-196 |
| | | D1-161 | D1-179 | D1-197 |
| | | D1-162 | D1-180 | D1-198 |
| | | D1-163 | D1-181 | D1-199 |
| 232 X 174 X 130 mm | | D1-164 | D1-182 | D1-200 |
| | | D1-165 | D1-183 | D1-201 |
| | | D1-166 | D1-184 | D1-202 |
| | | D1-167 | D1-185 | D1-203 |
| | | D1-168 | D1-186 | D1-204 |
| | | D1-169 | D1-187 | D1-205 |
| | | D1-170 | D1-188 | D1-206 |

TEL SEPET (Kapaklı)



| kod | dış boyut |
|---------------|---------------------|
| D2-010 | 175 x 153 x h:45 mm |

TEL SEPET (Kapaksız)



| kod | dış boyut |
|---------------|---------------------|
| D2-011 | 175 x 144 x h:30 mm |

DEPOLAMA ÇERÇEVESİ



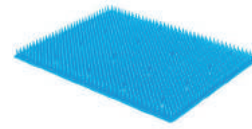
| kod | dış boyut |
|---------------|--------------|
| D4-005 | 170 x 140 mm |

ÖRTÜ TUTUCU



| kod | dış boyut |
|---------------|--------------|
| D4-006 | 170 x 140 mm |

SİLİKON ÇİM



| kod | dış boyut |
|---------------|--------------|
| D4-007 | 160 x 135 mm |

Mini Dental Model

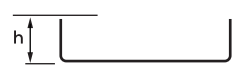
| YÜKSEKLİK | ÖZELLİKLER | Kapak (Delikli) | Kapak (Delikli) | Kapak (Deliksiz) | Kapak (Delikli) | Kapak (Delikli) |
|--------------------|------------|--|--|--|--|--|
| | | Kutu (Deliksiz) | Kutu (Delikli) | Kutu (Deliksiz) | Kutu (Deliksiz) | Kutu (Delikli) |
| 315 X 142 X 45 mm | | D1-250 D1-251 D1-252 D1-253 D1-254 D1-255 | D1-268 D1-269 D1-270 D1-271 D1-272 D1-273 | D1-286 D1-287 D1-288 D1-289 D1-290 D1-291 | D1-304 D1-305 D1-306 D1-307 D1-308 D1-309 | N/A |
| 315 X 142 X 70 mm | | D1-256 D1-257 D1-258 D1-259 D1-260 D1-261 | D1-274 D1-275 D1-276 D1-277 D1-278 D1-279 | D1-292 D1-293 D1-294 D1-295 D1-296 D1-297 | D1-310 D1-311 D1-312 D1-313 D1-314 D1-315 | D1-322 D1-323 D1-324 D1-325 D1-326 D1-327 |
| 315 X 142 X 100 mm | | D1-262 D1-263 D1-264 D1-265 D1-266 D1-267 | D1-280 D1-281 D1-282 D1-283 D1-284 D1-285 | D1-298 D1-299 D1-300 D1-301 D1-302 D1-303 | D1-316 D1-317 D1-318 D1-319 D1-320 D1-321 | D1-328 D1-329 D1-330 D1-331 D1-332 D1-333 |

TEL SEPET (Kapaklı)



| kod | dış boyut |
|---------------|---------------------|
| D2-015 | 268 x 127 x h:47 mm |

TEL SEPET (Kapaksız)



| kod | dış boyut |
|---------------|---------------------|
| D2-016 | 268 x 117 x h:50 mm |

DEPOLAMA ÇERÇEVESİ



| kod | dış boyut |
|---------------|--------------|
| D4-010 | 270 x 125 mm |

ÖRTÜ TUTUCU



| kod | dış boyut |
|---------------|--------------|
| D4-011 | 270 x 125 mm |

SİLİKON ÇİM



| kod | dış boyut |
|---------------|--------------|
| D4-012 | 275 x 125 mm |

Implant Model

| YÜKSEKLİK | ÖZELLİKLER | Kapak (Delikli) | Kapak (Delikli) | Kapak (Deliksiz) |
|-------------------|------------|-----------------|-----------------|------------------|
| | | Kutu (Deliksiz) | Kutu (Delikli) | Kutu (Deliksiz) |
| 300 X 150 X 75 mm | | D1-335 | D1-347 | D1-359 |
| | | D1-336 | D1-348 | D1-360 |
| | | D1-337 | D1-349 | D1-361 |
| | | D1-338 | D1-350 | D1-362 |
| | | D1-339 | D1-351 | D1-363 |
| | | D1-340 | D1-352 | D1-364 |
| | | D1-341 | D1-353 | D1-365 |
| 500 X 170 X 75 mm | | D1-342 | D1-354 | D1-366 |
| | | D1-343 | D1-355 | D1-367 |
| | | D1-344 | D1-356 | D1-368 |
| | | D1-345 | D1-357 | D1-369 |
| | | D1-346 | D1-358 | D1-370 |

Mini Implant Model

| YÜKSEKLİK | ÖZELLİKLER | Kapak (Delikli) | Kapak (Delikli) | Kapak (Deliksiz) |
|-------------------|------------|-----------------|-----------------|------------------|
| | | Kutu (Deliksiz) | Kutu (Delikli) | Kutu (Deliksiz) |
| 160 X 72 X 57 mm | | D1-371 | D1-383 | D1-395 |
| | | D1-372 | D1-384 | D1-396 |
| | | D1-373 | D1-385 | D1-397 |
| | | D1-374 | D1-386 | D1-398 |
| | | D1-375 | D1-387 | D1-399 |
| | | D1-376 | D1-388 | D1-400 |
| | | D1-377 | D1-389 | D1-401 |
| 200 X 147 X 57 mm | | D1-378 | D1-390 | D1-402 |
| | | D1-379 | D1-391 | D1-403 |
| | | D1-380 | D1-392 | D1-404 |
| | | D1-381 | D1-393 | D1-405 |
| | | D1-382 | D1-394 | D1-406 |

PRF System

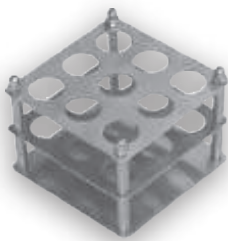


K1-001
PRF BOX FOR PROFESIONAL USE

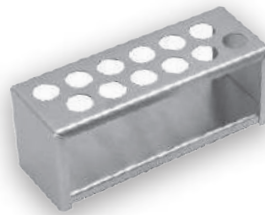


K1-002
PRF BOX FOR STUDENT USE

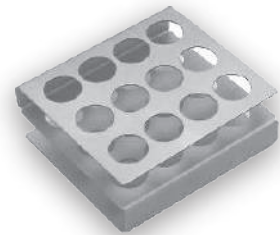
- Dental İmplant PRF Sistemi Platelet Zengin Fibrin kutusu,
daha hızlı cerrahi operasyonlara imkan veren birden fazla P.R.F'yi
yapmak için çok kullanışlı bir sistemdir.



K1-003 09 - HOLES
K1-004 12 - HOLES



K1-005 12 - HOLES



K1-006 12 - HOLES



K1-007
68 x 60 x 20 mm



K1-008
110 x 75 x 5 mm



K1-009
65 x 30 mm

PRF System



K1-010

K1-011

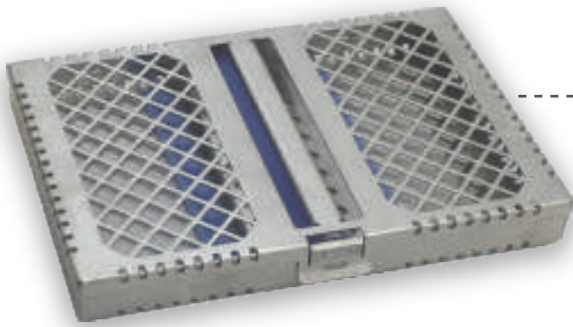
K1-012

K1-013

K1-014
GOLDMAN FOX
SCISSORS TC, 13 cm

K1-015
1 x 2 TEETH
12.5 cm

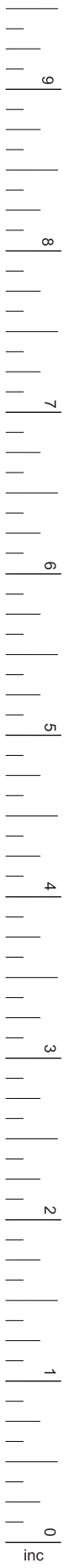
K1-016
PRF TWEEZER
16 cm



CASSETTE FOR 7
K1-017 220 x 125 x 25



CASSETTE FOR PRF
K1-018 220 x 200 x 34



Mesh Cassette



| | | |
|---------------|--------|----------------|
| 05 - CASSETTE | K1-019 | 195 x 80 x 32 |
| 07 - CASSETTE | K1-020 | 195 x 105 x 32 |
| 10 - CASSETTE | K1-021 | 195 x 140 x 32 |
| 20 - CASSETTE | K1-022 | 280 x 195 x 32 |

Elongated Cassette



05 - CASSETTE
K1-023 190 x 76 x 30



07 - CASSETTE
K1-024 190 x 102 x 30



10 - CASSETTE
K1-025 190 x 142 x 30



İNDEKS
INDEX

| CODE | PAGE | CODE | PAGE | CODE | PAGE |
|--------|--------|-------|------|--------|------|
| FC001 | 08 | FC33S | 19 | RT07K | 26 |
| FC002 | 08, 16 | RT02B | 22 | RT07K | 26 |
| FC007 | 08, 16 | RT03B | 22 | RT01F | 27 |
| FC017 | 08, 16 | RT04B | 22 | RT02F | 27 |
| FC018 | 08, 16 | RT07W | 22 | RT03F | 27 |
| FC013 | 09, 16 | RT10L | 22 | RT01C | 27 |
| FC033 | 09, 16 | RT04L | 22 | RT02C | 27 |
| FC33A | 09 | RT06L | 22 | RT01S | 27 |
| FC022 | 09, 16 | RT08L | 22 | RT02S | 27 |
| FC073 | 09 | RT11L | 22 | RT09H | 28 |
| FC004 | 10 | RT07L | 22 | RT10H | 28 |
| FC008 | 10 | RT09L | 22 | RT11H | 28 |
| FC0021 | 10 | RT01H | 22 | RT12H | 28 |
| FC079 | 10, 16 | RT02H | 22 | RT13H | 28 |
| FC79A | 10 | RT03H | 23 | RT14H | 28 |
| FC051 | 11 | RT04H | 23 | RT13C | 29 |
| FC51A | 11, 16 | RT05H | 23 | RT14C | 29 |
| FC51L | 11 | RT06H | 23 | RT15C | 29 |
| FC067 | 11, 16 | RT07H | 23 | RT03C | 29 |
| FC049 | 12 | RT08H | 23 | RT04C | 29 |
| FC048 | 12 | RT01A | 24 | RT05C | 29 |
| FC046 | 12 | RT02A | 24 | RT01W | 30 |
| FC074 | 13 | RT03A | 24 | RT02W | 30 |
| FC74N | 13 | RT04A | 24 | RT011W | 30 |
| FC075 | 13 | RT05A | 24 | RT012W | 30 |
| FC86A | 13 | RT06A | 24 | RT12L | 31 |
| FC087 | 14 | RT07A | 24 | RT05B | 31 |
| FC089 | 14 | RT01D | 25 | RT06B | 31 |
| FC090 | 14 | RT02D | 25 | RT01T | 32 |
| FC01S | 15 | RT03D | 25 | RT02T | 32 |
| FC02S | 15 | RT01M | 25 | RT03T | 32 |
| FC03S | 15 | RT02M | 25 | RT04T | 32 |
| FC01W | 15 | RT03M | 25 | RT05T | 32 |
| FC02W | 15 | RT01R | 25 | RT06T | 32 |
| FC100 | 16 | RT03W | 25 | RT07T | 32 |
| FC22S | 17, 19 | RT04W | 25 | SN001 | 33 |
| FC123 | 17 | RT05W | 25 | SN002 | 33 |
| FC13S | 17, 19 | RT01L | 26 | SN003 | 33 |
| FC161 | 17 | RT02L | 26 | SN004 | 33 |
| FC162 | 17 | RT03L | 26 | SN005 | 33 |
| FC037 | 18, 19 | RT01K | 26 | SN006 | 33 |
| FC158 | 18, 19 | RT02K | 26 | SN007 | 33 |
| FC039 | 18 | RT03K | 26 | SN008 | 33 |
| FC39R | 18, 19 | RT04K | 26 | SN009 | 33 |
| FC39L | 18, 19 | RT05K | 26 | SN010 | 33 |
| FC51S | 18, 19 | RT06K | 26 | SN011 | 33 |

| CODE | PAGE | CODE | PAGE | CODE | PAGE |
|-------|------|-------|------|-------|------|
| SN012 | 33 | CS006 | 40 | CS061 | 46 |
| SN013 | 33 | CS007 | 40 | CS062 | 46 |
| SN014 | 33 | CS008 | 40 | CS063 | 47 |
| SN015 | 33 | CS009 | 40 | CS064 | 47 |
| SN016 | 33 | CS010 | 40 | CS065 | 47 |
| SN017 | 33 | CS020 | 40 | CS066 | 47 |
| SN018 | 33 | CS021 | 40 | CS067 | 47 |
| SN019 | 33 | CS022 | 40 | CS068 | 47 |
| SN020 | 33 | CS023 | 40 | CS069 | 47 |
| SN021 | 33 | CS024 | 40 | PT001 | 50 |
| SN022 | 33 | CS025 | 40 | PT002 | 50 |
| SN023 | 34 | CS026 | 40 | PT003 | 50 |
| SN024 | 34 | CS027 | 41 | PT004 | 50 |
| SN025 | 34 | CS028 | 41 | PT005 | 50 |
| SN026 | 34 | CS029 | 41 | PT006 | 50 |
| SN027 | 34 | CS030 | 42 | PT007 | 50 |
| SN028 | 34 | CS031 | 41 | PT008 | 50 |
| SN029 | 34 | CS032 | 41 | PT009 | 50 |
| SN030 | 34 | CS033 | 41 | PT010 | 50 |
| PR001 | 35 | CS034 | 41 | PT011 | 50 |
| PR002 | 35 | CS035 | 42 | PT012 | 50 |
| PR003 | 35 | CS036 | 42 | PT013 | 51 |
| PR004 | 35 | CS037 | 42 | PT014 | 51 |
| PR005 | 35 | CS038 | 42 | PT016 | 51 |
| PR006 | 35 | CS039 | 42 | PT017 | 51 |
| PR007 | 35 | CS040 | 42 | PT018 | 52 |
| PR008 | 35 | CS041 | 42 | PT019 | 52 |
| PR009 | 36 | CS042 | 43 | PT020 | 52 |
| PR010 | 36 | CS043 | 43 | PT022 | 53 |
| PR011 | 36 | CS044 | 44 | PT023 | 53 |
| PR012 | 36 | CS045 | 43 | PT024 | 53 |
| PR013 | 36 | CS046 | 43 | PT025 | 53 |
| PR014 | 36 | CS047 | 44 | PT026 | 54 |
| CS001 | 38 | CS048 | 44 | PT027 | 54 |
| CS002 | 38 | CS049 | 44 | PT028 | 54 |
| CS003 | 38 | CS050 | 44 | PT029 | 54 |
| CS004 | 38 | CS051 | 44 | PT030 | 54 |
| CS012 | 39 | CS052 | 45 | PT031 | 55 |
| CS013 | 39 | CS053 | 45 | PT032 | 55 |
| CS014 | 39 | CS054 | 45 | PT033 | 55 |
| CS015 | 39 | CS055 | 45 | PT034 | 55 |
| CS016 | 39 | CS056 | 46 | PT035 | 56 |
| CS017 | 39 | CS057 | 46 | PT036 | 56 |
| CS018 | 39 | CS058 | 46 | PT037 | 56 |
| CS019 | 39 | CS059 | 46 | PT038 | 56 |
| CS005 | 39 | CS060 | 46 | PT039 | 56 |

| CODE | PAGE | CODE | PAGE | CODE | PAGE |
|-------|------|-------|------|-------|------|
| PT040 | 56 | KL045 | 63 | PN029 | 69 |
| PT041 | 56 | KL046 | 63 | PN030 | 69 |
| KL001 | 57 | KL047 | 63 | PN031 | 69 |
| KL002 | 57 | KL048 | 64 | PN032 | 69 |
| KL003 | 57 | KL049 | 64 | PN033 | 69 |
| KL004 | 57 | KL050 | 64 | PN034 | 69 |
| KL005 | 57 | KL051 | 64 | PN035 | 69 |
| KL006 | 58 | KL052 | 64 | PN036 | 69 |
| KL007 | 58 | KL053 | 64 | PN037 | 69 |
| KL008 | 58 | KL054 | 64 | PN038 | 69 |
| KL009 | 59 | KL055 | 64 | PN039 | 69 |
| KL010 | 59 | KL056 | 63 | PN040 | 69 |
| KL011 | 59 | KL057 | 63 | PN041 | 69 |
| KL012 | 59 | KL058 | 63 | PN042 | 69 |
| KL013 | 59 | KL059 | 63 | PN043 | 69 |
| KL014 | 59 | KL060 | 63 | PN044 | 69 |
| KL015 | 59 | KL061 | 63 | PN045 | 70 |
| KL016 | 59 | KL061 | 63 | PN046 | 70 |
| KL017 | 60 | PN001 | 66 | PN047 | 70 |
| KL018 | 60 | PN002 | 66 | PN048 | 70 |
| KL019 | 60 | PN003 | 66 | PN049 | 70 |
| KL020 | 60 | PN004 | 66 | PN050 | 70 |
| KL021 | 60 | PN005 | 66 | PN051 | 70 |
| KL022 | 60 | PN006 | 66 | PN052 | 70 |
| KL023 | 60 | PN007 | 66 | PN053 | 70 |
| KL024 | 60 | PN008 | 66 | PN054 | 70 |
| KL025 | 60 | PN009 | 66 | PN055 | 70 |
| KL026 | 60 | PN010 | 66 | PN056 | 71 |
| KL027 | 61 | PN011 | 67 | PN057 | 71 |
| KL028 | 61 | PN012 | 67 | PN058 | 71 |
| KL029 | 61 | PN013 | 67 | PN059 | 71 |
| KL030 | 61 | PN014 | 68 | PN060 | 71 |
| KL031 | 61 | PN015 | 67 | PN061 | 71 |
| KL032 | 61 | PN016 | 67 | PN062 | 71 |
| KL033 | 61 | PN017 | 67 | PN063 | 71 |
| KL034 | 61 | PN018 | 67 | PN064 | 71 |
| KL035 | 61 | PN019 | 67 | PN065 | 71 |
| KL036 | 61 | PN020 | 67 | PN066 | 71 |
| KL037 | 61 | PN021 | 68 | PN067 | 71 |
| KL038 | 62 | PN022 | 68 | PN068 | 71 |
| KL039 | 62 | PN023 | 68 | PN069 | 71 |
| KL040 | 62 | PN024 | 68 | PN070 | 71 |
| KL041 | 62 | PN025 | 68 | PN071 | 71 |
| KL042 | 62 | PN026 | 68 | PN072 | 72 |
| KL043 | 63 | PN027 | 68 | PN073 | 72 |
| KL044 | 63 | PN028 | 68 | PN074 | 72 |

| CODE | PAGE | CODE | PAGE | CODE | PAGE |
|-------|------|-------|------|-------|------|
| PN075 | 72 | EK026 | 78 | EK072 | 84 |
| PN076 | 72 | EK027 | 78 | EK073 | 84 |
| PN077 | 72 | EK028 | 78 | EK074 | 84 |
| PN078 | 72 | EK029 | 78 | EK075 | 84 |
| PN079 | 72 | EK030 | 78 | EK076 | 84 |
| PN080 | 72 | EK031 | 78 | EK077 | 84 |
| PN081 | 72 | EK032 | 78 | EK078 | 84 |
| PN082 | 72 | EK033 | 78 | EK079 | 84 |
| PN083 | 73 | EK034 | 79 | EK080 | 84 |
| PN084 | 73 | EK035 | 79 | EK081 | 85 |
| PN085 | 73 | EK036 | 79 | EK082 | 85 |
| PN086 | 72 | EK037 | 79 | EK083 | 85 |
| PN087 | 72 | EK038 | 79 | EK084 | 85 |
| PN088 | 72 | EK039 | 79 | EK085 | 85 |
| PN089 | 74 | EK040 | 80 | EK086 | 85 |
| PN090 | 74 | EK041 | 80 | EK087 | 85 |
| PN091 | 74 | EK042 | 80 | EK088 | 85 |
| PN092 | 74 | EK043 | 80 | EK089 | 85 |
| PN093 | 74 | EK044 | 81 | EK090 | 85 |
| PN094 | 74 | EK045 | 81 | EK091 | 86 |
| PN095 | 74 | EK046 | 81 | EK092 | 86 |
| EK001 | 76 | EK047 | 81 | EK093 | 86 |
| EK002 | 76 | EK048 | 81 | EK094 | 86 |
| EK003 | 76 | EK049 | 81 | EK095 | 86 |
| EK004 | 76 | EK050 | 81 | EK096 | 86 |
| EK005 | 76 | EK051 | 81 | EK097 | 86 |
| EK006 | 76 | EK052 | 82 | EK098 | 86 |
| EK007 | 76 | EK053 | 82 | EK099 | 86 |
| EK008 | 76 | EK054 | 82 | EK100 | 86 |
| EK009 | 76 | EK055 | 82 | EK101 | 86 |
| EK010 | 76 | EK056 | 82 | EK102 | 87 |
| EK011 | 77 | EK057 | 82 | EK103 | 87 |
| EK012 | 77 | EK058 | 82 | EK104 | 87 |
| EK013 | 77 | EK059 | 82 | EK105 | 87 |
| EK014 | 77 | EK060 | 82 | EK106 | 87 |
| EK015 | 77 | EK061 | 82 | EK107 | 87 |
| EK016 | 77 | EK062 | 82 | EK108 | 87 |
| EK017 | 77 | EK063 | 82 | EK109 | 88 |
| EK018 | 77 | EK064 | 83 | EK110 | 88 |
| EK019 | 77 | EK065 | 83 | EK111 | 88 |
| EK020 | 78 | EK066 | 83 | EK112 | 88 |
| EK021 | 78 | EK067 | 83 | EK113 | 88 |
| EK022 | 78 | EK068 | 83 | EK114 | 88 |
| EK023 | 78 | EK069 | 83 | EK115 | 88 |
| EK024 | 78 | EK070 | 84 | EK116 | 88 |
| EK025 | 78 | EK071 | 84 | EK117 | 88 |

| CODE | PAGE | CODE | PAGE | CODE | PAGE |
|-------|------|-------|------|-------|------|
| EK118 | 88 | KK027 | 95 | KN010 | 99 |
| KP001 | 90 | KK028 | 95 | KN011 | 99 |
| KP002 | 90 | KK029 | 95 | KN012 | 99 |
| KP003 | 90 | KK030 | 95 | PR039 | 100 |
| KP004 | 90 | KK031 | 95 | PR040 | 100 |
| KP005 | 90 | KE001 | 96 | PR041 | 100 |
| KP006 | 90 | KE002 | 96 | PR042 | 100 |
| KP007 | 90 | KE003 | 96 | PR043 | 100 |
| KP008 | 90 | KE004 | 96 | PR044 | 100 |
| KP009 | 90 | KE005 | 96 | PR045 | 100 |
| KP010 | 90 | KE006 | 96 | PR046 | 100 |
| KP011 | 91 | KE007 | 96 | PR047 | 100 |
| KP012 | 91 | KE008 | 96 | PR048 | 100 |
| KP013 | 91 | KE009 | 96 | PR049 | 100 |
| KP014 | 91 | KE010 | 96 | PR050 | 100 |
| KP015 | 92 | KE011 | 96 | PR051 | 101 |
| KP016 | 92 | KE012 | 96 | PR052 | 101 |
| KP017 | 92 | KE013 | 96 | PR053 | 101 |
| KP018 | 92 | PR021 | 98 | PR054 | 101 |
| KP019 | 92 | PR022 | 98 | PR055 | 101 |
| KK001 | 93 | PR023 | 98 | PR056 | 101 |
| KK002 | 93 | PR024 | 98 | PR057 | 101 |
| KK003 | 93 | PR025 | 98 | PR058 | 101 |
| KK004 | 93 | PR026 | 98 | PR059 | 101 |
| KK005 | 93 | PR027 | 98 | PR060 | 101 |
| KK006 | 93 | PR028 | 98 | PR061 | 101 |
| KK007 | 93 | PR029 | 98 | PR062 | 101 |
| KK008 | 93 | PR030 | 98 | PR063 | 101 |
| KK009 | 93 | PR031 | 98 | PR064 | 101 |
| KK010 | 93 | PR032 | 98 | PR065 | 101 |
| KK011 | 94 | PR033 | 99 | PR066 | 101 |
| KK012 | 94 | PR033 | 99 | PR100 | 101 |
| KK013 | 94 | PR034 | 99 | PR071 | 102 |
| KK014 | 94 | PR035 | 99 | PR072 | 102 |
| KK015 | 94 | PR036 | 99 | PR073 | 102 |
| KK016 | 94 | PR037 | 99 | PR074 | 102 |
| KK017 | 94 | PR038 | 99 | PR075 | 102 |
| KK018 | 94 | KN001 | 99 | PR076 | 102 |
| KK019 | 95 | KN002 | 99 | PR077 | 102 |
| KK020 | 95 | KN003 | 99 | PR078 | 102 |
| KK021 | 95 | KN004 | 99 | PR079 | 102 |
| KK022 | 95 | KN005 | 99 | PR200 | 102 |
| KK023 | 95 | KN006 | 99 | PR080 | 103 |
| KK024 | 95 | KN007 | 99 | PR081 | 103 |
| KK025 | 95 | KN008 | 99 | PR082 | 103 |
| KK026 | 95 | KN009 | 99 | PR083 | 103 |

| CODE | PAGE | CODE | PAGE | CODE | PAGE |
|-------|------|-------|------|-------|------|
| PR084 | 103 | KA01E | 110 | KA014 | 113 |
| PR085 | 103 | KA02E | 110 | KA015 | 113 |
| PR086 | 103 | KA03E | 110 | KA016 | 113 |
| PR087 | 103 | KA04E | 110 | KA017 | 113 |
| PR300 | 103 | KA05E | 110 | KA018 | 113 |
| OD200 | 103 | KA06E | 110 | KA019 | 113 |
| PS001 | 104 | KA07E | 110 | KA020 | 113 |
| PS002 | 104 | KA08E | 110 | KA021 | 113 |
| PS003 | 104 | KA09E | 110 | KA022 | 114 |
| PS004 | 104 | KA10E | 110 | KA023 | 114 |
| PS005 | 104 | KA11E | 110 | KA024 | 114 |
| PS006 | 104 | KA01T | 111 | KA025 | 114 |
| PS007 | 104 | KA02T | 111 | KA026 | 114 |
| PS008 | 104 | KA03T | 111 | KA027 | 114 |
| PS009 | 104 | KA04T | 111 | KA028 | 114 |
| PS010 | 104 | KA05T | 111 | KA029 | 114 |
| PS011 | 104 | KA06T | 111 | KA030 | 114 |
| PS012 | 104 | KA07T | 111 | KA031 | 114 |
| PS013 | 104 | KA08T | 111 | KA032 | 114 |
| PD027 | 105 | KA09T | 111 | KA033 | 114 |
| PD028 | 105 | KA10T | 111 | KA035 | 114 |
| PD029 | 105 | KA11T | 111 | KA035 | 114 |
| PD030 | 105 | KA12T | 111 | KA036 | 114 |
| PD031 | 105 | KA13T | 111 | KA037 | 114 |
| PD032 | 105 | KA14T | 111 | KA038 | 115 |
| PD033 | 105 | KA15T | 111 | KA039 | 115 |
| PD034 | 105 | KA16T | 111 | KA040 | 115 |
| PD035 | 105 | KA001 | 112 | KA041 | 115 |
| PD036 | 105 | KA002 | 112 | KA042 | 115 |
| KT001 | 106 | KA003 | 112 | KA043 | 115 |
| KT002 | 106 | KA004 | 112 | KA044 | 115 |
| KT003 | 106 | KA005 | 112 | KA045 | 115 |
| KT004 | 106 | KA006 | 112 | KA046 | 115 |
| KT005 | 106 | KA007 | 112 | KA047 | 115 |
| KT006 | 106 | EV001 | 112 | KA048 | 115 |
| KT007 | 106 | EV002 | 112 | KA049 | 115 |
| KT008 | 106 | EV003 | 112 | KA050 | 115 |
| KT009 | 106 | EV004 | 112 | KA051 | 115 |
| KT010 | 107 | EV005 | 112 | KA052 | 115 |
| KT011 | 107 | EV006 | 112 | KA053 | 116 |
| KT012 | 107 | EV007 | 112 | KA054 | 116 |
| KT013 | 107 | KA008 | 113 | KA055 | 116 |
| KT014 | 107 | KA009 | 113 | KA056 | 116 |
| KT015 | 107 | KA010 | 113 | KA057 | 116 |
| KT016 | 107 | KA011 | 113 | KA058 | 116 |
| KT017 | 107 | KA012 | 113 | KA059 | 116 |

| CODE | PAGE | CODE | PAGE | CODE | PAGE |
|-------|------|-------|------|-------|------|
| KA060 | 116 | AT002 | 121 | CR006 | 126 |
| KA061 | 116 | AT003 | 121 | CR007 | 126 |
| KA062 | 116 | AT004 | 121 | CR008 | 126 |
| SP001 | 117 | AT005 | 121 | CR009 | 126 |
| SP002 | 117 | AT006 | 122 | CR010 | 126 |
| SP003 | 117 | AT007 | 122 | CR011 | 126 |
| SP004 | 117 | AT008 | 122 | CR012 | 126 |
| SP005 | 117 | AT009 | 122 | CR013 | 126 |
| SP006 | 117 | AT010 | 122 | CR014 | 126 |
| SP007 | 117 | AT012 | 122 | CR015 | 126 |
| RD001 | 118 | MT015 | 123 | CR016 | 126 |
| RD002 | 118 | MT016 | 123 | CR017 | 126 |
| RD003 | 118 | MT017 | 123 | CR018 | 126 |
| RD004 | 118 | MT018 | 123 | CR019 | 126 |
| RD005 | 118 | MT019 | 123 | CR020 | 126 |
| RD006 | 118 | MT020 | 123 | CR021 | 126 |
| RD007 | 118 | MT021 | 123 | CR022 | 127 |
| RD008 | 118 | MT022 | 123 | CR023 | 127 |
| RD009 | 118 | MT023 | 123 | CR024 | 127 |
| RD010 | 118 | MT024 | 123 | CR025 | 127 |
| RD011 | 118 | MT025 | 124 | CR026 | 127 |
| RD012 | 118 | MT026 | 124 | CR027 | 127 |
| AY001 | 119 | MT027 | 124 | CR028 | 127 |
| AY002 | 119 | MT028 | 124 | CR029 | 127 |
| AY003 | 119 | MT029 | 124 | CR030 | 127 |
| AY004 | 119 | MT030 | 124 | CR031 | 127 |
| AY005 | 119 | MT031 | 124 | CR032 | 127 |
| AY006 | 119 | MT032 | 124 | CR033 | 127 |
| AY007 | 119 | MT033 | 124 | CR034 | 127 |
| AY008 | 119 | MT034 | 124 | CR035 | 127 |
| AY009 | 119 | MT035 | 124 | CR036 | 127 |
| AY010 | 119 | MT036 | 124 | CR037 | 127 |
| AY011 | 119 | MT037 | 124 | CR038 | 127 |
| PB001 | 120 | MT038 | 124 | CR039 | 128 |
| PB002 | 120 | MT039 | 124 | CR040 | 128 |
| PB003 | 120 | MT040 | 124 | CR041 | 128 |
| PB004 | 120 | MT041 | 124 | CR042 | 128 |
| PB005 | 120 | MT042 | 124 | CR043 | 128 |
| PB006 | 120 | MT043 | 124 | CR044 | 128 |
| PB007 | 120 | MT044 | 124 | CR045 | 128 |
| PB008 | 120 | MT045 | 124 | CR046 | 128 |
| PB009 | 120 | CR001 | 126 | CR047 | 128 |
| PB010 | 120 | CR002 | 126 | CR048 | 128 |
| PB011 | 120 | CR003 | 126 | CR049 | 128 |
| PB012 | 120 | CR004 | 126 | CR050 | 128 |
| AT001 | 121 | CR005 | 126 | CR051 | 128 |

| CODE | PAGE | CODE | PAGE | CODE | PAGE |
|-------|------|-------|------|-------|------|
| CR052 | 128 | CR097 | 131 | CR144 | 135 |
| CR053 | 128 | CR098 | 131 | CR145 | 135 |
| CR054 | 128 | CR099 | 131 | CR146 | 135 |
| CR055 | 128 | CR100 | 131 | CR147 | 135 |
| CR056 | 128 | CR101 | 131 | CR148 | 135 |
| CR057 | 128 | CR102 | 131 | CR149 | 135 |
| CR058 | 128 | CR103 | 132 | CR150 | 135 |
| CR059 | 128 | CR104 | 132 | CR152 | 136 |
| CR060 | 128 | CR105 | 132 | CR153 | 136 |
| CR061 | 128 | CR106 | 132 | CR154 | 136 |
| CR062 | 128 | CR107 | 132 | CR155 | 136 |
| CR063 | 128 | CR108 | 132 | CR156 | 136 |
| CR064 | 128 | CR109 | 132 | CR157 | 136 |
| CR065 | 128 | CR110 | 132 | CR158 | 136 |
| CR066 | 128 | CR111 | 133 | CR159 | 136 |
| CR067 | 128 | CR112 | 133 | CR160 | 136 |
| CR068 | 129 | CR113 | 133 | CR161 | 136 |
| CR069 | 129 | CR114 | 133 | CR162 | 136 |
| CR070 | 129 | CR115 | 133 | CR163 | 136 |
| CR071 | 129 | CR116 | 133 | CR164 | 136 |
| CR072 | 129 | CR117 | 133 | CR165 | 136 |
| CR073 | 129 | CR118 | 133 | CR166 | 136 |
| CR074 | 129 | CR119 | 133 | CR167 | 136 |
| CR075 | 129 | CR120 | 133 | CR168 | 136 |
| CR076 | 129 | CR121 | 133 | CR169 | 136 |
| CR077 | 129 | CR122 | 133 | CR170 | 137 |
| CR078 | 129 | CR123 | 133 | CR171 | 137 |
| CR079 | 129 | CR124 | 133 | CR172 | 137 |
| CR080 | 129 | CR126 | 134 | CR173 | 137 |
| CR081 | 129 | CR127 | 134 | CR174 | 137 |
| CR082 | 129 | CR128 | 134 | CR175 | 138 |
| CR083 | 129 | CR129 | 134 | CR176 | 138 |
| CR084 | 129 | CR130 | 134 | CR177 | 138 |
| CR085 | 129 | CR131 | 134 | CR178 | 138 |
| CR086 | 129 | CR132 | 134 | CR179 | 138 |
| CR087 | 130 | CR133 | 134 | CR180 | 138 |
| CR088 | 130 | CR134 | 134 | CR181 | 138 |
| CR089 | 130 | CR135 | 134 | CR182 | 138 |
| CR090 | 130 | CR136 | 134 | CR183 | 138 |
| CR091 | 130 | CR137 | 134 | CR184 | 138 |
| CR092 | 130 | CR138 | 134 | CR185 | 139 |
| CR093 | 130 | CR139 | 134 | CR186 | 139 |
| CR094 | 130 | CR140 | 134 | CR187 | 139 |
| CR095 | 130 | CR141 | 134 | CR188 | 139 |
| CR096 | 130 | CR142 | 134 | CR189 | 139 |
| CR097 | 131 | CR143 | 134 | CR190 | 139 |

| CODE | PAGE | CODE | PAGE | CODE | PAGE |
|-------|------|-------|------|-------|------|
| CR191 | 139 | CR237 | 144 | MS004 | 150 |
| CR192 | 139 | CR238 | 144 | MS005 | 150 |
| CR193 | 139 | CR239 | 144 | MS006 | 150 |
| CR194 | 139 | CR240 | 144 | MS007 | 150 |
| CR195 | 139 | CR241 | 144 | MS008 | 150 |
| CR196 | 139 | CR242 | 144 | MS009 | 151 |
| CR197 | 139 | CR243 | 144 | MS010 | 151 |
| CR198 | 139 | CR244 | 145 | MS011 | 151 |
| CR199 | 139 | CR245 | 145 | MS012 | 151 |
| CR200 | 138 | CR246 | 145 | MS013 | 151 |
| CR201 | 138 | CR247 | 145 | MS014 | 151 |
| CR202 | 138 | CR248 | 145 | MS015 | 151 |
| CR203 | 140 | CR249 | 145 | MS016 | 151 |
| CR204 | 140 | CR250 | 145 | MS017 | 151 |
| CR205 | 140 | CR251 | 145 | MS018 | 151 |
| CR206 | 140 | CR252 | 145 | MS019 | 152 |
| CR207 | 140 | CR253 | 145 | MS020 | 152 |
| CR208 | 140 | CR254 | 145 | MS021 | 152 |
| CR209 | 140 | CR255 | 145 | MS022 | 152 |
| CR210 | 140 | CR256 | 145 | MS023 | 152 |
| CR211 | 140 | CR257 | 145 | MS024 | 152 |
| CR212 | 140 | CR258 | 145 | MS025 | 152 |
| CR213 | 140 | CR259 | 145 | MS026 | 152 |
| CR214 | 141 | CR260 | 145 | MS027 | 152 |
| CR215 | 141 | CR261 | 146 | MS028 | 153 |
| CR216 | 141 | CR262 | 146 | MS029 | 153 |
| CR217 | 141 | CR263 | 146 | MS030 | 153 |
| CR218 | 141 | CR264 | 146 | MS031 | 153 |
| CR219 | 141 | CR265 | 146 | MS032 | 153 |
| CR220 | 141 | CR266 | 146 | MS033 | 153 |
| CR221 | 141 | CR267 | 146 | MS034 | 153 |
| CR222 | 141 | CR268 | 146 | MS035 | 154 |
| CR223 | 141 | CR269 | 146 | MS036 | 154 |
| CR224 | 142 | CR270 | 146 | MS037 | 154 |
| CR225 | 142 | CR271 | 146 | MS038 | 154 |
| CR226 | 142 | CR271 | 146 | MS039 | 154 |
| CR227 | 142 | CR280 | 147 | MS040 | 155 |
| CR228 | 143 | CR281 | 147 | MS041 | 155 |
| CR229 | 143 | CR282 | 147 | MS042 | 155 |
| CR230 | 143 | CR283 | 147 | MS043 | 155 |
| CR231 | 143 | CR284 | 147 | MS044 | 155 |
| CR232 | 143 | CR285 | 147 | MS045 | 155 |
| CR233 | 144 | CR286 | 147 | MS046 | 155 |
| CR234 | 144 | MS001 | 150 | MS047 | 155 |
| CR235 | 144 | MS002 | 150 | MS048 | 155 |
| CR236 | 144 | MS003 | 150 | MS049 | 155 |

| CODE | PAGE | CODE | PAGE | CODE | PAGE |
|-------|------|-------|------|-------|------|
| MS050 | 156 | MS096 | 160 | MS142 | 165 |
| MS051 | 156 | MS097 | 161 | MS143 | 165 |
| MS052 | 156 | MS098 | 161 | MS144 | 165 |
| MS053 | 156 | MS099 | 161 | MS145 | 165 |
| MS054 | 156 | MS100 | 161 | MS146 | 165 |
| MS055 | 156 | MS101 | 161 | MS147 | 165 |
| MS056 | 156 | MS102 | 161 | MS148 | 165 |
| MS057 | 156 | MS103 | 161 | MS149 | 166 |
| MS058 | 157 | MS104 | 161 | MS150 | 166 |
| MS059 | 157 | MS105 | 161 | MS151 | 166 |
| MS060 | 157 | MS106 | 161 | MS152 | 166 |
| MS061 | 157 | MS107 | 162 | MS153 | 166 |
| MS062 | 157 | MS108 | 162 | MS154 | 166 |
| MS063 | 157 | MS109 | 162 | MS155 | 166 |
| MS064 | 157 | MS110 | 162 | MS156 | 166 |
| MS065 | 157 | MS111 | 162 | MS157 | 166 |
| MS066 | 157 | MS112 | 162 | MS158 | 167 |
| MS067 | 157 | MS113 | 162 | MS159 | 167 |
| MS068 | 157 | MS114 | 162 | MS160 | 167 |
| MS069 | 157 | MS115 | 162 | MS161 | 167 |
| MS070 | 157 | MS116 | 162 | MS162 | 167 |
| MS071 | 158 | MS117 | 162 | MS163 | 167 |
| MS072 | 158 | MS118 | 162 | MS164 | 168 |
| MS073 | 158 | MS119 | 163 | MS165 | 168 |
| MS074 | 158 | MS120 | 163 | MS166 | 168 |
| MS075 | 158 | MS121 | 163 | MS167 | 168 |
| MS076 | 158 | MS122 | 163 | MS168 | 168 |
| MS077 | 158 | MS123 | 163 | MS169 | 168 |
| MS078 | 158 | MS124 | 163 | MS170 | 168 |
| MS079 | 158 | MS125 | 163 | MS171 | 168 |
| MS080 | 158 | MS126 | 163 | MS172 | 168 |
| MS081 | 158 | MS127 | 163 | MS173 | 169 |
| MS082 | 159 | MS128 | 163 | MS174 | 169 |
| MS083 | 159 | MS129 | 163 | MS175 | 169 |
| MS084 | 159 | MS130 | 163 | MS176 | 169 |
| MS085 | 159 | MS131 | 163 | MS177 | 169 |
| MS086 | 159 | MS132 | 163 | MS178 | 169 |
| MS087 | 159 | MS133 | 164 | MS179 | 169 |
| MS088 | 159 | MS134 | 164 | MS180 | 170 |
| MS089 | 159 | MS135 | 164 | MS181 | 170 |
| MS090 | 160 | MS136 | 164 | MS182 | 170 |
| MS091 | 160 | MS137 | 164 | MS183 | 170 |
| MS092 | 160 | MS138 | 164 | MS184 | 170 |
| MS093 | 160 | MS139 | 164 | MS185 | 170 |
| MS094 | 160 | MS140 | 164 | MS186 | 170 |
| MS095 | 160 | MS141 | 164 | MS187 | 170 |

| CODE | PAGE | CODE | PAGE | CODE | PAGE |
|-------|------|-------|------|-------|------|
| MS188 | 170 | MS234 | 175 | MS280 | 180 |
| MS189 | 170 | MS235 | 175 | MS282 | 180 |
| MS190 | 171 | MS236 | 175 | MS283 | 180 |
| MS191 | 171 | MS237 | 175 | MS284 | 180 |
| MS192 | 171 | MS238 | 175 | MS285 | 180 |
| MS193 | 171 | MS239 | 175 | MS286 | 180 |
| MS194 | 171 | MS240 | 175 | MS287 | 180 |
| MS195 | 171 | MS241 | 175 | MS288 | 180 |
| MS196 | 171 | MS242 | 176 | MS289 | 180 |
| MS197 | 171 | MS243 | 176 | MS290 | 181 |
| MS198 | 171 | MS244 | 176 | MS291 | 181 |
| MS199 | 171 | MS245 | 176 | MS292 | 181 |
| MS200 | 172 | MS246 | 176 | MS293 | 181 |
| MS201 | 172 | MS247 | 176 | MS294 | 181 |
| MS202 | 172 | MS248 | 176 | MS295 | 181 |
| MS203 | 172 | MS249 | 176 | MS296 | 181 |
| MS204 | 172 | MS250 | 176 | MS297 | 182 |
| MS205 | 172 | MS251 | 176 | MS298 | 182 |
| MS206 | 172 | MS252 | 176 | MS299 | 182 |
| MS207 | 172 | MS253 | 176 | MS300 | 182 |
| MS208 | 172 | MS254 | 176 | MS301 | 182 |
| MS209 | 173 | MS255 | 176 | MS302 | 182 |
| MS210 | 173 | MS256 | 176 | MS303 | 182 |
| MS211 | 173 | MS257 | 176 | MS304 | 182 |
| MS212 | 173 | MS258 | 177 | MS305 | 182 |
| MS213 | 173 | MS259 | 177 | MS306 | 183 |
| MS214 | 173 | MS260 | 177 | MS307 | 183 |
| MS215 | 173 | MS261 | 177 | MS308 | 183 |
| MS216 | 173 | MS262 | 177 | MS309 | 183 |
| MS217 | 173 | MS263 | 177 | MS310 | 183 |
| MS218 | 174 | MS264 | 178 | MS311 | 183 |
| MS219 | 174 | MS265 | 178 | MS312 | 183 |
| MS220 | 174 | MS266 | 178 | MS313 | 184 |
| MS221 | 174 | MS267 | 178 | MS314 | 184 |
| MS222 | 174 | MS268 | 178 | MS315 | 184 |
| MS223 | 174 | MS269 | 178 | MS316 | 184 |
| MS224 | 174 | MS270 | 178 | MS317 | 184 |
| MS225 | 175 | MS271 | 178 | MS318 | 184 |
| MS226 | 175 | MS272 | 178 | MS319 | 184 |
| MS227 | 175 | MS273 | 179 | MS320 | 184 |
| MS228 | 175 | MS274 | 179 | MS321 | 184 |
| MS229 | 175 | MS275 | 179 | MS322 | 184 |
| MS230 | 175 | MS276 | 179 | MS323 | 185 |
| MS231 | 175 | MS277 | 179 | MS324 | 185 |
| MS232 | 175 | MS278 | 179 | MS325 | 185 |
| MS233 | 175 | MS279 | 179 | MS326 | 185 |

| CODE | PAGE | CODE | PAGE | CODE | PAGE |
|-------|------|-------|------|-------|------|
| MS327 | 185 | OD005 | 192 | OD050 | 198 |
| MS328 | 185 | OD006 | 192 | OD051 | 198 |
| MS329 | 185 | OD007 | 192 | OD052 | 198 |
| MS330 | 185 | OD008 | 192 | OD053 | 198 |
| MS331 | 186 | OD009 | 193 | OD054 | 198 |
| MS332 | 186 | OD010 | 193 | OD055 | 198 |
| MS333 | 186 | OD011 | 193 | OD056 | 198 |
| MS334 | 186 | OD012 | 193 | OD057 | 199 |
| MS335 | 186 | OD013 | 193 | OD058 | 199 |
| MS336 | 186 | OD014 | 193 | OD059 | 199 |
| MS337 | 186 | OD015 | 193 | OD060 | 199 |
| MS338 | 186 | OD016 | 193 | OD061 | 199 |
| MS339 | 186 | OD017 | 194 | OD062 | 199 |
| MS340 | 187 | OD018 | 194 | OD063 | 199 |
| MS341 | 187 | OD019 | 194 | OD064 | 199 |
| MS342 | 187 | OD020 | 194 | OD065 | 200 |
| MS343 | 187 | OD021 | 194 | OD066 | 200 |
| MS344 | 187 | OD022 | 194 | OD067 | 200 |
| MS345 | 187 | OD023 | 194 | OD068 | 200 |
| MS346 | 187 | OD024 | 194 | OD069 | 200 |
| MS347 | 187 | OD025 | 195 | OD070 | 200 |
| MS348 | 188 | OD026 | 195 | OD071 | 200 |
| MS349 | 188 | OD027 | 195 | OD072 | 200 |
| MS350 | 188 | OD028 | 195 | OD073 | 201 |
| MS351 | 188 | OD029 | 195 | OD074 | 201 |
| MS352 | 188 | OD030 | 195 | OD075 | 201 |
| MS353 | 188 | OD031 | 195 | OD076 | 201 |
| MS354 | 188 | OD032 | 195 | OD077 | 201 |
| MS355 | 189 | OD032 | 196 | OD078 | 201 |
| MS356 | 189 | OD033 | 196 | OD079 | 201 |
| MS357 | 189 | OD034 | 196 | OD080 | 201 |
| MS358 | 189 | OD035 | 196 | OD081 | 201 |
| MS359 | 189 | OD036 | 196 | OD082 | 201 |
| MS360 | 189 | OD037 | 196 | OD083 | 201 |
| MS361 | 190 | OD038 | 196 | OD084 | 201 |
| MS362 | 190 | OD039 | 196 | OD085 | 201 |
| MS363 | 190 | OD040 | 196 | OD086 | 201 |
| MS364 | 190 | OD041 | 197 | OD087 | 202 |
| MS365 | 190 | OD042 | 197 | OD088 | 202 |
| MS366 | 190 | OD043 | 197 | OD089 | 202 |
| MS367 | 190 | OD044 | 197 | OD090 | 202 |
| OD001 | 192 | OD045 | 197 | OD091 | 202 |
| OD002 | 192 | OD046 | 197 | OD092 | 202 |
| OD003 | 192 | OD047 | 197 | OD093 | 202 |
| OD004 | 192 | OD048 | 197 | OD094 | 202 |
| OD005 | 192 | OD049 | 198 | OD095 | 202 |

| CODE | PAGE | CODE | PAGE | CODE | PAGE |
|--------|------|--------|------|--------|------|
| OD100 | 202 | B1-046 | 204 | B1-092 | 204 |
| B1-001 | 204 | B1-047 | 204 | B1-093 | 204 |
| B1-002 | 204 | B1-048 | 204 | B1-094 | 204 |
| B1-003 | 204 | B1-049 | 204 | B1-095 | 204 |
| B1-004 | 204 | B1-050 | 204 | B1-096 | 204 |
| B1-005 | 204 | B1-051 | 204 | B1-097 | 204 |
| B1-006 | 204 | B1-052 | 204 | B1-098 | 204 |
| B1-007 | 204 | B1-053 | 204 | B1-099 | 204 |
| B1-008 | 204 | B1-054 | 204 | B1-100 | 204 |
| B1-009 | 204 | B1-055 | 204 | B1-101 | 204 |
| B1-010 | 204 | B1-056 | 204 | B1-102 | 204 |
| B1-011 | 204 | B1-057 | 204 | B1-103 | 204 |
| B1-012 | 204 | B1-058 | 204 | B1-104 | 204 |
| B1-013 | 204 | B1-059 | 204 | B1-105 | 204 |
| B1-014 | 204 | B1-060 | 204 | B1-106 | 204 |
| B1-015 | 204 | B1-061 | 204 | B1-107 | 204 |
| B1-016 | 204 | B1-062 | 204 | B1-108 | 204 |
| B1-017 | 204 | B1-063 | 204 | B1-109 | 204 |
| B1-018 | 204 | B1-064 | 204 | B1-110 | 204 |
| B1-019 | 204 | B1-065 | 204 | B1-111 | 204 |
| B1-020 | 204 | B1-066 | 204 | B1-112 | 204 |
| B1-021 | 204 | B1-067 | 204 | B1-113 | 204 |
| B1-022 | 204 | B1-068 | 204 | B1-114 | 204 |
| B1-023 | 204 | B1-069 | 204 | B2-001 | 205 |
| B1-024 | 204 | B1-070 | 204 | B2-002 | 205 |
| B1-025 | 204 | B1-071 | 204 | B2-003 | 205 |
| B1-026 | 204 | B1-072 | 204 | B2-004 | 205 |
| B1-027 | 204 | B1-073 | 204 | B2-005 | 205 |
| B1-028 | 204 | B1-074 | 204 | B2-006 | 205 |
| B1-029 | 204 | B1-075 | 204 | B2-007 | 205 |
| B1-030 | 204 | B1-076 | 204 | B2-008 | 205 |
| B1-031 | 204 | B1-077 | 204 | B3-001 | 205 |
| B1-032 | 204 | B1-078 | 204 | B3-002 | 205 |
| B1-033 | 204 | B1-079 | 204 | B3-003 | 205 |
| B1-034 | 204 | B1-080 | 204 | B3-004 | 205 |
| B1-035 | 204 | B1-081 | 204 | B3-005 | 205 |
| B1-036 | 204 | B1-082 | 204 | B3-006 | 205 |
| B1-037 | 204 | B1-083 | 204 | B3-007 | 205 |
| B1-038 | 204 | B1-084 | 204 | B3-008 | 205 |
| B1-039 | 204 | B1-085 | 204 | B1-150 | 206 |
| B1-040 | 204 | B1-086 | 204 | B1-151 | 206 |
| B1-041 | 204 | B1-087 | 204 | B1-152 | 206 |
| B1-042 | 204 | B1-088 | 204 | B1-153 | 206 |
| B1-043 | 204 | B1-089 | 204 | B1-154 | 206 |
| B1-044 | 204 | B1-090 | 204 | B1-155 | 206 |
| B1-045 | 204 | B1-091 | 204 | B1-156 | 206 |

| CODE | PAGE | CODE | PAGE | CODE | PAGE |
|--------|------|--------|------|--------|------|
| B1-157 | 206 | B1-199 | 206 | B1-235 | 208 |
| B1-158 | 206 | B1-200 | 206 | B1-236 | 208 |
| B1-159 | 206 | B1-201 | 206 | B1-237 | 208 |
| B1-160 | 206 | B1-202 | 206 | B1-238 | 208 |
| B1-161 | 206 | B1-203 | 206 | B1-239 | 208 |
| B1-162 | 206 | B1-204 | 206 | B1-240 | 208 |
| B1-163 | 206 | B1-205 | 206 | B1-241 | 208 |
| B1-164 | 206 | B1-206 | 206 | B1-242 | 208 |
| B1-165 | 206 | B1-207 | 206 | B1-243 | 208 |
| B1-166 | 206 | B1-209 | 206 | B1-244 | 208 |
| B1-167 | 206 | B1-210 | 206 | B1-245 | 208 |
| B1-168 | 206 | B1-211 | 206 | B1-246 | 208 |
| B1-169 | 206 | B1-212 | 206 | B1-247 | 208 |
| B1-170 | 206 | B1-213 | 206 | B1-248 | 208 |
| B1-171 | 206 | B1-214 | 206 | B1-249 | 208 |
| B1-172 | 206 | B1-215 | 206 | B1-250 | 208 |
| B1-173 | 206 | B1-216 | 206 | B1-251 | 208 |
| B1-174 | 206 | B1-217 | 206 | B1-252 | 208 |
| B1-175 | 206 | B1-218 | 206 | B1-253 | 208 |
| B1-176 | 206 | B1-219 | 206 | B1-254 | 208 |
| B1-177 | 206 | B1-220 | 206 | B1-255 | 208 |
| B1-178 | 206 | B1-221 | 206 | B1-256 | 208 |
| B1-179 | 206 | B1-222 | 206 | B1-257 | 208 |
| B1-180 | 206 | B2-010 | 207 | B1-258 | 208 |
| B1-181 | 206 | B2-011 | 207 | B1-259 | 208 |
| B1-182 | 206 | B2-012 | 207 | B1-260 | 208 |
| B1-183 | 206 | B2-013 | 207 | B1-261 | 208 |
| B1-184 | 206 | B3-015 | 207 | B1-262 | 208 |
| B1-185 | 206 | B3-016 | 207 | B1-263 | 208 |
| B1-186 | 206 | B3-017 | 207 | B1-264 | 208 |
| B1-187 | 206 | B3-018 | 207 | B1-265 | 208 |
| B1-188 | 206 | B3-019 | 207 | B1-266 | 208 |
| B1-189 | 206 | B3-020 | 207 | B1-267 | 208 |
| B1-190 | 206 | B3-021 | 207 | B1-268 | 208 |
| B1-191 | 206 | B3-022 | 207 | B1-269 | 208 |
| B1-192 | 206 | B3-023 | 207 | B1-270 | 208 |
| B1-193 | 206 | B1-225 | 208 | B1-271 | 208 |
| B1-194 | 206 | B1-226 | 208 | B1-272 | 208 |
| B1-195 | 206 | B1-227 | 208 | B1-273 | 208 |
| B1-196 | 206 | B1-228 | 208 | B1-274 | 208 |
| B1-197 | 206 | B1-229 | 208 | B1-275 | 208 |
| B1-198 | 206 | B1-230 | 208 | B1-276 | 208 |
| B1-199 | 206 | B1-231 | 208 | B1-277 | 208 |
| B1-198 | 206 | B1-232 | 208 | B1-278 | 208 |
| B1-198 | 206 | B1-233 | 208 | B1-279 | 208 |
| B1-198 | 206 | B1-234 | 208 | B1-280 | 208 |

| CODE | PAGE | CODE | PAGE | CODE | PAGE |
|--------|------|---------|------|---------|------|
| B1-281 | 208 | B1-326 | 208 | A1-023B | 212 |
| B1-281 | 208 | B1-327 | 208 | A1-024B | 212 |
| B1-282 | 208 | B1-328 | 208 | A1-025P | 214 |
| B1-283 | 208 | B1-329 | 208 | A1-026P | 214 |
| B1-284 | 208 | B1-330 | 208 | A1-027P | 214 |
| B1-285 | 208 | B1-331 | 208 | A1-028P | 214 |
| B1-286 | 208 | B1-332 | 208 | A1-029P | 214 |
| B1-287 | 208 | B1-333 | 208 | A1-030V | 214 |
| B1-288 | 208 | B1-354 | 203 | A1-031V | 214 |
| B1-289 | 208 | B1-355 | 203 | A1-032V | 214 |
| B1-290 | 208 | B1-356 | 203 | A1-033V | 214 |
| B1-291 | 208 | B2-015 | 209 | A1-034V | 214 |
| B1-292 | 208 | B2-016 | 209 | A1-035P | 214 |
| B1-293 | 208 | B2-017 | 209 | A1-036P | 214 |
| B1-294 | 208 | B2-018 | 209 | A1-037P | 214 |
| B1-295 | 208 | B3-025 | 209 | A1-038P | 214 |
| B1-296 | 208 | B3-026 | 209 | A1-039P | 214 |
| B1-297 | 208 | B3-027 | 209 | D1-001 | 216 |
| B1-298 | 208 | B3-028 | 209 | D1-002 | 216 |
| B1-299 | 208 | B3-029 | 209 | D1-003 | 216 |
| B1-300 | 208 | B3-030 | 209 | D1-004 | 216 |
| B1-301 | 208 | B3-031 | 209 | D1-005 | 216 |
| B1-302 | 208 | B3-032 | 209 | D1-006 | 216 |
| B1-303 | 208 | B3-033 | 209 | D1-007 | 216 |
| B1-304 | 208 | A1-001P | 210 | D1-008 | 216 |
| B1-305 | 208 | A1-002P | 210 | D1-009 | 216 |
| B1-306 | 208 | A1-003P | 210 | D1-010 | 216 |
| B1-307 | 208 | A1-004P | 210 | D1-011 | 216 |
| B1-308 | 208 | A1-005P | 210 | D1-012 | 216 |
| B1-309 | 208 | A1-006V | 210 | D1-013 | 216 |
| B1-310 | 208 | A1-007V | 210 | D1-014 | 216 |
| B1-311 | 208 | A1-008V | 210 | D1-015 | 216 |
| B1-312 | 208 | A1-009V | 210 | D1-016 | 216 |
| B1-313 | 208 | A1-010V | 210 | D1-017 | 216 |
| B1-314 | 208 | A1-011B | 210 | D1-018 | 216 |
| B1-315 | 208 | A1-012B | 210 | D2-001 | 217 |
| B1-316 | 208 | A1-013B | 210 | D2-002 | 217 |
| B1-317 | 208 | A1-014B | 210 | D2-003 | 217 |
| B1-318 | 208 | A1-015B | 210 | D3-001 | 217 |
| B1-319 | 208 | A1-016P | 212 | D3-002 | 217 |
| B1-320 | 208 | A1-017P | 212 | D3-003 | 217 |
| B1-321 | 208 | A1-018P | 212 | D3-004 | 217 |
| B1-322 | 208 | A1-019V | 212 | D3-005 | 217 |
| B1-323 | 208 | A1-020V | 212 | D3-006 | 217 |
| B1-324 | 208 | A1-021V | 212 | D1-020 | 218 |
| B1-325 | 208 | A1-022B | 212 | D1-021 | 218 |

| CODE | PAGE | CODE | PAGE | CODE | PAGE |
|--------|------|--------|------|--------|------|
| D1-022 | 218 | D1-068 | 218 | D1-155 | 219 |
| D1-023 | 218 | D1-069 | 218 | D1-156 | 219 |
| D1-024 | 218 | D1-070 | 218 | D1-157 | 219 |
| D1-025 | 218 | D1-071 | 218 | D1-158 | 219 |
| D1-026 | 218 | D1-072 | 218 | D1-159 | 219 |
| D1-027 | 218 | D1-073 | 218 | D1-160 | 219 |
| D1-028 | 218 | D1-074 | 218 | D1-161 | 219 |
| D1-029 | 218 | D1-075 | 218 | D1-162 | 219 |
| D1-030 | 218 | D1-076 | 218 | D1-163 | 219 |
| D1-031 | 218 | D1-077 | 218 | D1-164 | 219 |
| D1-032 | 218 | D1-078 | 218 | D1-165 | 219 |
| D1-033 | 218 | D1-079 | 218 | D1-166 | 219 |
| D1-034 | 218 | D1-080 | 218 | D1-167 | 219 |
| D1-035 | 218 | D1-081 | 218 | D1-168 | 219 |
| D1-036 | 218 | D1-082 | 218 | D1-169 | 219 |
| D1-037 | 218 | D1-083 | 218 | D1-170 | 219 |
| D1-038 | 218 | D1-084 | 218 | D1-171 | 219 |
| D1-039 | 218 | D1-085 | 218 | D1-172 | 219 |
| D1-040 | 218 | D1-086 | 218 | D1-173 | 219 |
| D1-041 | 218 | D1-087 | 218 | D1-174 | 219 |
| D1-042 | 218 | D1-088 | 218 | D1-175 | 219 |
| D1-043 | 218 | D1-089 | 218 | D1-176 | 219 |
| D1-044 | 218 | D1-090 | 218 | D1-177 | 219 |
| D1-045 | 218 | D1-091 | 218 | D1-178 | 219 |
| D1-046 | 217 | D1-092 | 218 | D1-179 | 219 |
| D1-047 | 218 | D1-093 | 218 | D1-180 | 219 |
| D1-048 | 218 | D1-094 | 218 | D1-181 | 219 |
| D1-049 | 218 | D1-095 | 218 | D1-182 | 219 |
| D1-050 | 218 | D1-096 | 218 | D1-183 | 219 |
| D1-051 | 218 | D1-097 | 218 | D1-184 | 219 |
| D1-052 | 218 | D1-098 | 218 | D1-185 | 219 |
| D1-053 | 218 | D1-099 | 218 | D1-186 | 219 |
| D1-054 | 218 | D1-100 | 218 | D1-187 | 219 |
| D1-055 | 218 | D1-101 | 218 | D1-188 | 219 |
| D1-056 | 218 | D1-102 | 218 | D1-189 | 219 |
| D1-057 | 218 | D1-103 | 218 | D1-190 | 219 |
| D1-058 | 218 | D2-005 | 217 | D1-191 | 219 |
| D1-059 | 218 | D2-006 | 217 | D1-192 | 219 |
| D1-060 | 218 | D4-001 | 218 | D1-193 | 219 |
| D1-061 | 218 | D4-002 | 218 | D1-194 | 219 |
| D1-062 | 218 | D4-003 | 218 | D1-195 | 219 |
| D1-063 | 218 | D1-150 | 219 | D1-196 | 219 |
| D1-064 | 218 | D1-151 | 219 | D1-197 | 219 |
| D1-065 | 218 | D1-152 | 219 | D1-198 | 219 |
| D1-066 | 218 | D1-153 | 219 | D1-199 | 219 |
| D1-067 | 218 | D1-154 | 219 | D1-200 | 219 |

| CODE | PAGE | CODE | PAGE | CODE | PAGE |
|--------|------|--------|------|--------|------|
| D1-201 | 219 | D1-288 | 220 | D2-015 | 220 |
| D1-202 | 219 | D1-289 | 220 | D2-016 | 220 |
| D1-203 | 219 | D1-290 | 220 | D4-010 | 220 |
| D2-010 | 219 | D1-291 | 220 | D4-011 | 220 |
| D2-011 | 219 | D1-292 | 220 | D4-012 | 220 |
| D4-005 | 219 | D1-293 | 220 | D1-335 | 221 |
| D4-006 | 219 | D1-294 | 220 | D1-336 | 221 |
| D4-007 | 219 | D1-295 | 220 | D1-337 | 221 |
| D1-250 | 220 | D1-296 | 220 | D1-338 | 221 |
| D1-251 | 220 | D1-297 | 220 | D1-339 | 221 |
| D1-252 | 220 | D1-298 | 220 | D1-340 | 221 |
| D1-253 | 220 | D1-299 | 220 | D1-341 | 221 |
| D1-254 | 220 | D1-300 | 220 | D1-342 | 221 |
| D1-255 | 220 | D1-301 | 220 | D1-343 | 221 |
| D1-256 | 220 | D1-302 | 220 | D1-344 | 221 |
| D1-257 | 220 | D1-303 | 220 | D1-345 | 221 |
| D1-258 | 220 | D1-304 | 220 | D1-346 | 221 |
| D1-259 | 220 | D1-305 | 220 | D1-347 | 221 |
| D1-260 | 220 | D1-306 | 220 | D1-348 | 221 |
| D1-261 | 220 | D1-307 | 220 | D1-349 | 221 |
| D1-262 | 220 | D1-308 | 220 | D1-350 | 221 |
| D1-263 | 220 | D1-309 | 220 | D1-351 | 221 |
| D1-264 | 220 | D1-310 | 220 | D1-352 | 221 |
| D1-265 | 220 | D1-311 | 220 | D1-353 | 221 |
| D1-266 | 220 | D1-312 | 220 | D1-354 | 221 |
| D1-267 | 220 | D1-313 | 220 | D1-355 | 221 |
| D1-268 | 220 | D1-314 | 220 | D1-356 | 221 |
| D1-269 | 220 | D1-315 | 220 | D1-357 | 221 |
| D1-270 | 220 | D1-316 | 220 | D1-358 | 221 |
| D1-271 | 220 | D1-317 | 220 | D1-359 | 221 |
| D1-272 | 220 | D1-318 | 220 | D1-360 | 221 |
| D1-273 | 220 | D1-319 | 220 | D1-361 | 221 |
| D1-274 | 220 | D1-320 | 220 | D1-362 | 221 |
| D1-275 | 220 | D1-321 | 220 | D1-363 | 221 |
| D1-276 | 220 | D1-322 | 220 | D1-364 | 221 |
| D1-277 | 220 | D1-323 | 220 | D1-365 | 221 |
| D1-278 | 220 | D1-324 | 220 | D1-366 | 221 |
| D1-279 | 220 | D1-325 | 220 | D1-367 | 221 |
| D1-280 | 220 | D1-326 | 220 | D1-368 | 221 |
| D1-281 | 220 | D1-327 | 220 | D1-369 | 221 |
| D1-282 | 220 | D1-328 | 220 | D1-370 | 221 |
| D1-283 | 220 | D1-329 | 220 | D1-371 | 221 |
| D1-284 | 220 | D1-330 | 220 | D1-372 | 221 |
| D1-285 | 220 | D1-331 | 220 | D1-373 | 221 |
| D1-286 | 220 | D1-332 | 220 | D1-374 | 221 |
| D1-287 | 220 | D1-333 | 220 | D1-375 | 221 |

| CODE | PAGE | CODE | PAGE | CODE | PAGE |
|---------|------|---------|------|------|------|
| D1-376 | 221 | K15-001 | 223 | | |
| D1-377 | 221 | K16-001 | 223 | | |
| D1-378 | 221 | K17-001 | 223 | | |
| D1-379 | 221 | K18-001 | 223 | | |
| D1-380 | 221 | K19-001 | 224 | | |
| D1-381 | 221 | K20-001 | 224 | | |
| D1-382 | 221 | K21-001 | 224 | | |
| D1-383 | 221 | K22-001 | 224 | | |
| D1-384 | 221 | K23-001 | 224 | | |
| D1-385 | 221 | K24-001 | 224 | | |
| D1-386 | 221 | K25-001 | 224 | | |
| D1-387 | 221 | | | | |
| D1-388 | 221 | | | | |
| D1-389 | 221 | | | | |
| D1-390 | 221 | | | | |
| D1-391 | 221 | | | | |
| D1-392 | 221 | | | | |
| D1-393 | 221 | | | | |
| D1-394 | 221 | | | | |
| D1-395 | 221 | | | | |
| D1-396 | 221 | | | | |
| D1-397 | 221 | | | | |
| D1-398 | 221 | | | | |
| D1-399 | 221 | | | | |
| D1-400 | 221 | | | | |
| D1-401 | 221 | | | | |
| D1-402 | 221 | | | | |
| D1-403 | 221 | | | | |
| D1-404 | 221 | | | | |
| D1-405 | 221 | | | | |
| D1-406 | 221 | | | | |
| K1-001 | 222 | | | | |
| K2-001 | 222 | | | | |
| K3-001 | 222 | | | | |
| K4-001 | 222 | | | | |
| K5-001 | 222 | | | | |
| K6-001 | 222 | | | | |
| K7-001 | 222 | | | | |
| K8-001 | 222 | | | | |
| K9-001 | 222 | | | | |
| K10-001 | 223 | | | | |
| K11-001 | 223 | | | | |
| K12-001 | 223 | | | | |
| K13-001 | 223 | | | | |
| K14-001 | 223 | | | | |



ONUR DİŞ DEPOSU
Tıbbi Gereçler San. ve Tic. Ltd. Şti
www.onurdental.com

📍 **Merkez / Head Office**
Millet Cd. Lütüfpaşa Sk.
No:50/1 34093
FATİH / İSTANBUL / TÜRKİYE
☎️ +9 0212 635 78 84/85/86
📠 +9 0212 635 78 90

📍 **Üretim / Manufacture**
İlkadım Sanayi Bölgesi İstiklal
Mh. 53 Sk. No:39
TEKKEKÖY / SAMSUN / TÜRKİYE
☎️ +9 0362 231 34 34
📠 +9 0362 231 34 33

📍 **Şube / Branch Office**
Varlık Mh. 100. Yıl Bulvarı
Gazi No:99/A
MURATPAŞA / ANTALYA / TÜRKİYE
☎️ +9 0242 244 10 30
📠 +9 0242 244 10 40